

# Mathematical analysis of the nonsteady flow of micropolar fluid in a thin domain

---

Radulović, Marko

Doctoral thesis / Disertacija

2019

Degree Grantor / Ustanova koja je dodijelila akademski / stručni stupanj: **University of Zagreb, Faculty of Science / Sveučilište u Zagrebu, Prirodoslovno-matematički fakultet**

Permanent link / Trajna poveznica: <https://um.nsk.hr/um:nbn:hr:217:347626>

Rights / Prava: [In copyright](#) / [Zaštićeno autorskim pravom.](#)

Download date / Datum preuzimanja: **2025-02-06**



Repository / Repozitorij:

[Repository of the Faculty of Science - University of Zagreb](#)





University of Zagreb

FACULTY OF SCIENCE  
DEPARTMENT OF MATHEMATICS

Marko Radulović

**Mathematical analysis of the nonsteady  
flow of micropolar fluid in a thin domain**

DOCTORAL THESIS

Zagreb, 2019



Sveučilište u Zagrebu

PRIRODOSLOVNO - MATEMATIČKI FAKULTET  
MATEMATIČKI ODSJEK

Marko Radulović

**Matematička analiza nestacionarnog  
toka mikropolarnog fluida u tankoj  
domeni**

DOKTORSKI RAD

Zagreb, 2019.



University of Zagreb

FACULTY OF SCIENCE  
DEPARTMENT OF MATHEMATICS

Marko Radulović

**Mathematical analysis of the nonsteady  
flow of micropolar fluid in a thin domain**

DOCTORAL THESIS

Supervisor:  
prof.dr.sc. Igor Pažanin

Zagreb, 2019



Sveučilište u Zagrebu

PRIRODOSLOVNO - MATEMATIČKI FAKULTET  
MATEMATIČKI ODSJEK

Marko Radulović

**Matematička analiza nestacionarnog  
toka mikropolarnog fluida u tankoj  
domeni**

DOKTORSKI RAD

Mentor:  
prof.dr.sc. Igor Pažanin

Zagreb, 2019.

# Acknowledgement

This dissertation is a result of continuing support of wonderful people that helped me through the process.

First of all, I would like to thank my mentor Igor Pažanin for his patient guidance and help.

I owe a big thank you to my parents Slavenko and Marina as well as to my whole family for their belief in me and their encouragement during these years.

I owe a special thank you to my girlfriend Tea for her support and warmness.

Finally, I thank my colleagues from the Department of Mathematics who have encouraged me to always look forward and delve deeper into scientific research as well as my best friends Luka, Mislav and Ivan for their insight and discussions which resulted with my deep love with mathematics.



# Summary

The main subject of this dissertation consists of studying the micropolar fluid model, which represents a generalization of the well-known classical Navier–Stokes model, mainly in the sense that it takes into account the microstructure of the fluid and effects such as shrinking and rotation of the particles of the fluid.

Our first goal is to prove the existence and uniqueness of a generalized nonsteady micropolar Poiseuille solution in an infinite cylinder. This is achieved by decomposing the problem into two parts: the classical two-dimensional micropolar problem with known existence and uniqueness results and the micropolar inverse problem, where we prove the corresponding results using semidiscretization in time.

Next, we derive an asymptotic model for the nonsteady micropolar fluid flow in a thin pipe assuming the solution has the uni-directional nonsteady micropolar Poiseuille form. The problem is separated by linearity and we treat two problems by constructing two-scale asymptotic approximations in powers of  $\epsilon$ , representing the pipe's thickness. The model is justified via error estimates in the appropriate norms. In the case of circular cross-section and external force functions depending only on time, naturally appearing in many applications, the asymptotic expansion is explicitly computed up to the second order and numerical illustrations are provided to indicate the effect of the correctors.

Finally, a more complex model is proposed describing the nonsteady micropolar fluid flow in a thin curved pipe, and the effects of flexion, torsion, micropolarity and time derivative are studied. The asymptotic expansions are explicitly computed up to the second-order and the model is justified by means of the error estimate in general as well as for special cases.

**Keywords:** micropolar fluid; nonsteady flow; thin domain; curved pipe; micropolar Poiseuille solution; asymptotic expansion; rigorous justification.

**2010 Mathematics Subject Classification:** 35C20; 35Q35; 76M45





# Sažetak

Glavna tema ove disertacije je proučavanje modela mikropolarnog fluida, koji predstavlja generalizaciju dobro poznatog klasičnog Navier–Stokesovog modela, prvenstveno u smislu da uzima u obzir mikrostrukturu fluida i efekte kao što su smanjivanje i rotacija čestica fluida.

Naš prvi cilj je dokazati egzistenciju i jedinstvenost generaliziranog nestacionarnog mikropolarnog Poiseuille rješenja u beskonačnom cilindru. Ovo postizemo rastavljanjem problema na dva dijela: klasični dvodimenzionalni mikropolarni problem s poznatim rezultatima egzistencije i jedinstvenosti te mikropolarni inverzni problem, gdje dokazujemo odgovarajuće rezultate semidiskretizacijom u vremenu.

Nadalje, izvodimo asimptotički model za nestacionarni tok mikropolarnog fluida u tankoj cijevi pod pretpostavkom da rješenje ima Poiseuilleov jednosmjerni nestacionarni mikropolarni oblik. Problem razdvajamo po linearnosti i tretiramo dva problema konstruirajući dvoskalnu asimptotičku aproksimaciju u potencijama parametra  $\epsilon$ , koji predstavlja debljinu cijevi. Model je opravdan koristeći ocjenu pogreške u odgovarajućim normama. U slučaju kružnog poprečnog presjeka i funkcija vanjskih sila koje ovise samo o vremenu, koji se prirodno pojavljuju u raznim primjenama, asimptotički razvoj je izračunat eksplicitno do drugog reda i numeričke ilustracije su prezentirane kako bi se jasnije naznačio utjecaj korektora.

Napokon, na kraju predlažemo i složeniji model koji opisuje nestacionarni tok mikropolarnog fluida u tankoj zakrivljenoj cijevi te se proučavaju efekti fleksije, torzije, mikropolarnosti kao i utjecaja vremenske derivacije. Asimptotički razvoji su izračunati eksplicitno do drugog reda i model je opravdan ocjenom pogreške u općenitom kao i u specijalnim slučajevima.

**Ključne riječi:** mikropolarni fluid; nestacionaran tok; tanka domena; zakrivljena cijev; mikropolarno Poiseuille rješenje; asimptotički razvoj; rigorozno opravdanje.

**2010 Mathematics Subject Classification:** 35C20; 35Q35; 76M45



# Prošireni sažetak

Glavna tema ove disertacije je proučavanje modela mikropolarnog fluida, koji predstavlja generalizaciju dobro poznatog klasičnog Navier–Stokesovog modela, prvenstveno u smislu da uzima u obzir mikrostrukturu fluida i efekte kao što su smanjivanje i rotacija čestica fluida. Mnogi ne–Newtonovski fluidi kao što su tekući kristali, krv, određeni polimerni fluidi te čak i voda na malenim skalama mogu se bolje i preciznije opisati ovim modelom. Kako bi opisali rotaciju čestica, uvodimo novo vektorsko polje – mikrorotaciju, te sukladno tome, novu jednadžbu koja dolazi od zakona sačuvanja angularnog momenta. Na ovaj način, dobivamo upareni sustav parcijalnih diferencijalnih jednadžbi s četiri nova koeficijenta viskoznosti.

Naš prvi cilj je dokazati egzistenciju i jedinstvenost generaliziranog nestacionarnog mikropolarnog Poiseuille rješenja u beskonačnom cilindru. Ovo postizemo rastavljanjem problem na dva dijela: klasični dvodimenzionalni mikropolarni problem s poznatim rezultatima egzistencije i jedinstvenosti te mikropolarni inverzni problem. Egzistencija jedinstvenog rješenja za mikropolarni inverzni problem je dokazana korištenjem semidiskretizacije u vremenu, dokazivanjem egzistencije rješenja diskretnog problema, izvođenjem odgovarajućih apriornih ocjena za diskretne aproksimacije te tretirajući zasebno slučaj  $T = \infty$ . Na ovaj način, dokazujemo egzistenciju i jedinstvenost rješenja originalnog uparenog problema za  $T \in (0, \infty]$ .

Nadalje, izvodimo asimptotički model za nestacionarni tok mikropolarnog fluida u tanjoj cijevi pod pretpostavkom da rješenje ima Poiseuilleov jednosmjerni nestacionarni mikropolarni oblik. Problem razdvajamo po linearnosti i tretiramo dva problema konstruirajući dvoskalnu asimptotičku aproksimaciju po potencijama parametra  $\epsilon$ , koji predstavlja debljinu cijevi. Nadalje, kako u procesu zanemarujemo inicijalne uvjete, konstruiramo korektore rubnog sloja u vremenu i dokazujemo odgovarajuće rezultate za njih. Model je opravdan ocjenom pogreške razlike rješenja originalnog problema i dobivene asimptotičke aproksimacije u odgovarajućim normama. U slučaju kružnog poprečnog presjeka i funkcija vanjskih sila koje ovise samo o vremenu, koji se prirodno pojavljuje u raznim primjenama, asimptotički razvoj je izračunat u eksplicitnom obliku do drugog reda i numeričke ilustracije su prezentirane kako bi se jasnije naznačio utjecaj korektora.

Napokon, na kraju predlažemo i složeniji model koji opisuje nestacionarni tok mikropolarnog fluida u tankoj zakrivljenoj cijevi te se proučavaju efekti fleksije, torzije, mikropolarnosti kao i utjecaja vremenske derivacije. Uvodeći Germanov referentni sustav i krivolinijske koordinate, zapisujemo problem u nedeformiranoj domeni. Koristeći tehniku dvoskalnog razvoja, računamo asimptotičku aproksimaciju do drugog reda. Također, analiziramo rubni sloj u prostoru te konstruiramo korektor divergencije kako bi poboljšali red točnosti predloženog modela. Asimptotički razvoji su eksplicitno izračunati do drugog reda i model je opravdan ocjenom pogreške u općenitom kao i u specijalnim slučajevima.

Glavni rezultati ove disertacije objavljeni su u radovima [5], [6], [30] i [31].

# Table of Contents

<b>Introduction</b>	<b>1</b>
<b>Function Spaces</b>	<b>3</b>
<b>1 Micropolar Fluid Model</b>	<b>5</b>
1.1 Kinematics . . . . .	5
1.1.1 Material and Spatial Coordinates . . . . .	5
1.1.2 Transport Theorem . . . . .	7
1.1.3 Continuity Equation . . . . .	8
1.2 Dynamics . . . . .	9
1.2.1 Principle of Conservation of Linear Momentum . . . . .	9
1.2.2 Conservation of Angular Momentum . . . . .	10
1.2.3 Energy Equation . . . . .	12
1.3 Micropolar fluids . . . . .	14
1.3.1 Isotropic Polar Fluids . . . . .	14
1.3.2 Constitutive Equations for Micropolar Fluids . . . . .	14
1.3.3 Micropolar Field Equations . . . . .	15
<b>2 Existence and Uniqueness of the Generalized Nonsteady Micropolar Poiseuille Solution</b>	<b>17</b>
2.1 Micropolar Equations . . . . .	18
2.2 Solvability of Problem (2.8) . . . . .	21
2.3 Solvability of Problem (2.9)–(2.10) . . . . .	22
2.3.1 Discrete Approximations on $\langle 0, T \rangle$ . . . . .	23
2.3.2 Apriori Estimates . . . . .	27
2.3.3 Temporal Interpolants and Uniform Estimates . . . . .	34
2.3.4 Passage to the Limit . . . . .	34
2.3.5 Solvability of Problem (2.9)–(2.10) on $\langle 0, \infty \rangle$ . . . . .	35
2.4 Existence and Uniqueness Result for the Coupled Problem (2.8)–(2.10) . .	40
2.5 Solvability of Parabolic Systems in Hilbert Spaces . . . . .	42

<b>3</b>	<b>Asymptotic Analysis of the Nonsteady Micropolar Fluid Flow in a Thin Undeformed Pipe</b>	<b>45</b>
3.1	Setting of the Problem . . . . .	46
3.2	Micropolar Heat Problem (MHP) . . . . .	50
3.2.1	Regular Part of the Asymptotic Expansion . . . . .	51
3.2.2	Boundary Layer in Time . . . . .	53
3.3	Micropolar Inverse Problem (MIP) . . . . .	58
3.3.1	Regular Part of the Asymptotic Expansion . . . . .	60
3.3.2	Boundary Layer in Time . . . . .	64
3.4	Rigorous Justification of the Model . . . . .	70
<b>4</b>	<b>Asymptotic Analysis of the Nonsteady Micropolar Fluid Flow in a Thin Curved Pipe</b>	<b>77</b>
4.1	Setting of the Problem . . . . .	78
4.1.1	Description of the Domain . . . . .	78
4.1.2	Micropolar Equations . . . . .	79
4.2	Curvilinear Coordinates . . . . .	81
4.2.1	Geometric Tools . . . . .	81
4.2.2	Christoffel Symbols . . . . .	84
4.2.3	Asymptotic Behaviour . . . . .	84
4.2.4	Differential Operators . . . . .	85
4.2.5	Equations in the Reference Domain . . . . .	85
4.3	Asymptotic Expansion . . . . .	88
4.3.1	Regular Part . . . . .	88
4.3.2	Boundary Layer . . . . .	97
4.3.3	Divergence Correction . . . . .	105
4.4	Rigorous Justification of the Model . . . . .	110
4.4.1	Apriori Estimates . . . . .	110
4.4.2	Error Estimates . . . . .	115
<b>A</b>	<b>Asymptotic Approximation for the Straight Circular Pipe</b>	<b>123</b>
A.1	Setting of the Problem . . . . .	123
A.2	Micropolar Heat Problem . . . . .	127
A.2.1	Zero-Order Approximation . . . . .	128
A.2.2	First-Order Corrector . . . . .	129
A.2.3	Second-Order Corrector . . . . .	130
A.3	Micropolar Inverse Problem . . . . .	134
A.3.1	Zero-Order Approximation . . . . .	135
A.3.2	First-Order Corrector . . . . .	136
A.3.3	Second-Order Corrector . . . . .	137

---

A.4	Asymptotic Approximation . . . . .	138
A.5	Numerical Example . . . . .	140
A.5.1	Second-Order Corrector . . . . .	140
A.5.2	Asymptotic Approximation . . . . .	141
<b>B</b>	<b>Differential Operators in Curvilinear Coordinates</b>	<b>143</b>
B.1	Time Derivative Operator . . . . .	143
B.2	Gradient Operator . . . . .	143
B.3	Divergence Operator . . . . .	145
B.4	Gradient Divergence Operator . . . . .	145
B.5	Laplace Operator . . . . .	146
B.6	Rotation Operator . . . . .	148
<b>C</b>	<b>Correctors and Boundary Layer Functions for the Curved-Pipe Flow</b>	<b>149</b>
C.1	Regular Part of the Expansion . . . . .	149
C.1.1	First-Order Corrector . . . . .	149
C.1.2	Second-Order Corrector . . . . .	150
C.2	Boundary Layers . . . . .	158
C.2.1	Boundary Layers for Velocity and Pressure . . . . .	158
C.2.2	Boundary Layers for Microrotation . . . . .	160
	<b>Bibliography</b>	<b>163</b>
	<b>Curriculum Vitae</b>	<b>167</b>





# Introduction

In this dissertation, we study the micropolar fluid model. Our main contribution consists in rigorous derivation of new asymptotic models describing the nonsteady flow of a micropolar fluid in thin domains such as an undeformed thin pipe and curved thin pipe. These models are extremely relevant from the point of view of applications as they can describe many processes, primarily that of the blood flow in biomedicine.

In preliminary Chapter 1, we derive the micropolar fluid field equations from the general conservative laws, namely the principles of conservation of mass, linear and angular momentum, as well as the first law of thermodynamics, following considerations in [22, Chapter I].

In Chapter 2, following [5], we present the existence and uniqueness proof of the generalized nonsteady micropolar Poiseuille solution. In order to achieve this, we decompose our problem and obtain the classical 2D micropolar problem with well-known existence and uniqueness results and the micropolar inverse problem. The existence of the unique solution to the micropolar inverse problem is proved using semidiscretization in time, establishing the existence of a solution to the discrete problem, deriving a-priori estimates for the discrete approximation and then using the compactness method as well as treating the case of  $T = \infty$ . In this way, we deduce the existence and uniqueness results for the solution of the original problem for  $T \in \langle 0, \infty \rangle$ .

In Chapter 3, following results presented in [6], a new asymptotic model for the nonsteady micropolar fluid flow in a thin undeformed pipe is derived. Assuming the solution has the uni-directional micropolar Poiseuille form, we separate the problem by linearity and obtain two problems: the micropolar heat and micropolar inverse problem. For each problem, we rescale the domain, construct two-scale asymptotic expansions in powers of  $\epsilon$  up to an arbitrary order by simultaneously solving the boundary-value problem for the velocity and microrotation. Since, in the process, the initial conditions have been neglected, the boundary-layers-in-time are considered and the corresponding results proved for the boundary-layer-in-time correctors. Finally, we derive error estimates in suitable norms evaluating the difference between the original solution and our approximation, thus justifying the proposed model.

In Chapter 4, following [30], we propose an asymptotic model for the nonsteady flow of micropolar fluid in a thin curved pipe. We introduce Germano's frame of reference as well as the curvilinear coordinates and rewrite the governing problem in an undeformed pipe. Using the two-scale expansion technique, we compute the asymptotic approximation up to the second-order in order to capture the effects of pipe's geometry, micropolarity and the time derivative. Furthermore, we provide the boundary layer analysis and construct the divergence correctors in order to improve the order of accuracy of the effective model. The error estimates in suitable norms are provided in the general case as well as in the special cases.

In Appendix A, we explicitly compute and numerically visualize the zero-order approximation, first and second order correctors for the velocity and microrotation in the special case of the straight thin pipe with circular cross-section and external force functions dependent on time (see [31]).

In Appendix B, we provide explicit expressions for the operators in curvilinear coordinates employed in the derivation of the model from Chapter 4.

Finally, in Appendix C, we provide the explicit expressions for the first and second order correctors of the velocity and microrotation from Chapter 4, as well as the expressions for the exponentially decaying functions appearing in the boundary layer correctors.

# Function Spaces

Let  $T \in \langle 0, \infty \rangle$  and let  $\Omega$  be a bounded subset of  $\mathbb{R}^n$ ,  $n = 2, 3$ .

We denote by  $W^{1,2}(\Omega)^n$ ,  $L^2(0, T; L^2(\Omega)^n)$ ,  $L^2(0, T; W^{1,2}(\Omega)^n)$ ,  $L^2(0, T; W^{2,2}(\Omega)^n)$ ,  $W^{1,2}(0, T; L^2(\Omega)^n)$ ,  $L^\infty(0, T; L^2(\Omega)^n)$  and  $L^\infty(0, T; W^{1,2}(\Omega)^n)$  the spaces with the finite norms:

$$\begin{aligned} \|\mathbf{u}\|_{W^{1,2}(\Omega)^n} &= \left( \int_{\Omega} (|\mathbf{u}(x, t)|^2 + |\nabla \mathbf{u}(x, t)|^2) dx \right)^{1/2}, \\ \|\mathbf{u}\|_{L^2(0, T; L^2(\Omega)^n)} &= \left( \int_0^T \int_{\Omega} |\mathbf{u}(x, t)|^2 dx dt \right)^{1/2}, \\ \|\mathbf{u}\|_{L^2(0, T; W^{1,2}(\Omega)^n)} &= \left( \int_0^T \int_{\Omega} (|\mathbf{u}(x, t)|^2 + |\nabla \mathbf{u}(x, t)|^2) dx dt \right)^{1/2}, \\ \|\mathbf{u}\|_{L^2(0, T; W^{2,2}(\Omega)^n)} &= \left( \sum_{|\alpha|=0}^2 \int_0^T \int_{\Omega} |D_x^\alpha \mathbf{u}(x, t)|^2 dx dt \right)^{1/2}, \\ \|\mathbf{u}\|_{W^{1,2}(0, T; L^2(\Omega)^n)} &= \left( \int_0^T \int_{\Omega} (|\mathbf{u}(x, t)|^2 + \left| \frac{\partial \mathbf{u}(x, t)}{\partial t} \right|^2) dx dt \right)^{1/2}, \\ \|\mathbf{u}\|_{L^\infty(0, T; L^2(\Omega)^n)} &= \sup_{t \in [0, T]} \left( \int_{\Omega} |\mathbf{u}(\cdot, t)|^2 dx \right)^{1/2}, \\ \|\mathbf{u}\|_{L^\infty(0, T; W^{1,2}(\Omega)^n)} &= \sup_{t \in [0, T]} \left( \int_{\Omega} (|\mathbf{u}(\cdot, t)|^2 + |\nabla \mathbf{u}(\cdot, t)|^2) dx \right)^{1/2}, \end{aligned}$$

where  $D_x^\alpha = \frac{\partial^{|\alpha|}}{\partial x_1^{\alpha_1} \dots \partial x_n^{\alpha_n}}$ ,  $|\alpha| = \alpha_1 + \dots + \alpha_n$ .

The spaces  $W_0^{1,2}(\Omega)^n$ ,  $L^\infty(0, T; W_0^{1,2}(\Omega)^n)$  and  $L^2(0, T; W_0^{1,2}(\Omega)^n)$  are the subspaces of  $W^{1,2}(\Omega)^n$ ,  $L^\infty(0, T; W^{1,2}(\Omega)^n)$  and  $L^2(0, T; W^{1,2}(\Omega)^n)$ , respectively, consisting of functions satisfying the condition  $\mathbf{u}(x, t)|_{\partial\Omega} = 0$ .

Moreover, we define the space  $L^2(0, T; V)$  as the space with the finite norm:

$$\|\mathbf{u}\|_{L^2(0, T; V)} = \left( \int_0^T \|\mathbf{u}\|_V^2 dt \right)^{1/2}.$$

In particular, we can take  $V = H^{1/2}(\partial\Omega)^n$  with

$$\|\mathbf{u}\|_{H^{1/2}(\partial\Omega)^n} = \inf_{\mathbf{v} \in W^{1,2}(\Omega)^n} \|\mathbf{v}\|_{W^{1,2}(\Omega)^n}.$$



# Chapter 1

## Micropolar Fluid Model

The model of micropolar fluid was first introduced in 60's by Eringen in his well-known paper [12], providing a generalization of the classical Navier–Stokes model. The main advantage of the micropolar fluid model is due to the fact that it takes into account the microstructure of the fluid particles and effects such as rotation and shrinking. Consequently, numerous non-Newtonian fluids such as liquid crystals, blood, certain polymeric fluids and even water in small scales can be described in a more precise and realistic manner. In order to describe the rotation of the particles, a new vector field is introduced – the angular velocity field of rotation (microrotation), and accordingly, a new equation coming from the conservation of the angular momentum. In this way, we obtain a coupled system of PDEs with four new viscosity coefficients.

In this Chapter, our goal is to derive the micropolar field equations from the general conservative laws following the considerations in [22, Chapter I]. In Section 1.1, we introduce the material and spatial coordinates and derive the continuity equation from the principle of conservation of mass using the transport theorem. Furthermore, in Section 1.2, we derive the respective equations from the principles of conservation of linear and angular momentum as well as the first law of thermodynamics. Finally, in Section 1.3, we summarize the results and write the micropolar field equations.

### 1.1 Kinematics

#### 1.1.1 Material and Spatial Coordinates

We introduce a fixed rectangular coordinate system  $(x_1, x_2, x_3)$  and refer to the coordinate triple  $(x_1, x_2, x_3)$  as the position and denote it by  $x$ .

Let us consider a particle  $P$  moving with the fluid, occupying a position  $X = (X_1, X_2, X_3)$  at time  $t = 0$  and the position  $x = (x_1, x_2, x_3)$  at some other time  $t$ ,  $-\infty < t < \infty$ . Then

$x$  is determined as a function of  $X$  and  $t$  in the following way:

$$x = x(X, t). \quad (1.1)$$

We assume that the transformation (1.1) is continuous and invertible, thus having the inverse in the form:

$$X = X(x, t).$$

Since the transformation (1.1) has a differentiable inverse, it follows that its Jacobian

$$J = J(X, t) = \det\left(\frac{\partial x_i}{\partial X_j}\right),$$

is such that

$$0 < J < \infty. \quad (1.2)$$

We describe the state of motion at a given point  $x$  and a given time  $t$  by functions such as  $\rho = \rho(x, t)$ ,  $\theta = \theta(x, t)$  and  $\mathbf{u} = \mathbf{u}(x, t)$  representing density, temperature and velocity, respectively.

It now follows that due to the transformation (1.1), any such function  $f$  can be expressed in terms of material coordinates as:

$$f(x, t) = f(x(X), t) = F(X, t). \quad (1.3)$$

The velocity  $\mathbf{u}$  at time  $t$  of a particle with initial position  $X$  is given by

$$\mathbf{u}(x, t) = \mathbf{U}(X, t) = \frac{d}{dt}x(X, t), \quad (1.4)$$

where  $x = x(X, t)$ . We can now determine the transformation (1.1) by solving the ordinary differential equation

$$\frac{d}{dt}x(X, t) = \mathbf{u}(x(X, t), t),$$

with  $x(X, 0) = X$ , where  $X$  is a parameter.

Let  $f$  and  $F$  be related with (1.3). Then there holds the following relation:

$$\frac{d}{dt}F(X, t) = \frac{d}{dt}f(x(X, t), t) = \frac{\partial f}{\partial x_i}(x(X, t), t) \frac{dx_i}{dt} + \frac{\partial f}{\partial t}(x(X, t), t).$$

Now, using (1.4), we obtain

$$\frac{d}{dt}F(X, t) = \frac{D}{Dt}f(x, t), \quad (1.5)$$

where

$$\frac{D}{Dt}f(x, t) \equiv \frac{\partial f}{\partial t}(x, t) + \mathbf{u}(x, t) \cdot \nabla f(x, t),$$

is called the material derivative of  $f$ .

### 1.1.2 Transport Theorem

Let  $\Omega(t)$  denote an arbitrary volume moving with the fluid and let  $f(x, t)$  be a scalar or vector function of position and time.

The transport theorem states that

$$\frac{d}{dt} \int_{\Omega(t)} f(x, t) dx = \int_{\Omega(t)} \left( \frac{\partial f}{\partial t}(x, t) + \mathbf{u}(x, t) \cdot \nabla f(x, t) + f(x, t) \operatorname{div} \mathbf{u}(x, t) \right) dx. \quad (1.6)$$

To prove the identity (1.6), we consider the transformation

$$x: \Omega(0) \rightarrow \Omega(t), \quad x = x(X, t),$$

as in (1.1). There holds the relation

$$\int_{\Omega(t)} f(x, t) dx = \int_{\Omega(0)} f(x(X, t), t) J(X, t) dX = \int_{\Omega(0)} F(X, t) J(X, t) dX,$$

implying

$$\begin{aligned} \frac{d}{dt} \int_{\Omega(t)} f(x, t) dx &= \frac{d}{dt} \int_{\Omega(0)} F(X, t) J(X, t) dX \\ &= \int_{\Omega(0)} \left( \frac{d}{dt} F(X, t) J(X, t) + F(X, t) \frac{d}{dt} J(X, t) \right) dX. \end{aligned} \quad (1.7)$$

Using identity (1.5), we now get

$$\begin{aligned} &\int_{\Omega(0)} \frac{d}{dt} F(X, t) J(X, t) dX \\ &= \int_{\Omega(0)} \left( \frac{\partial f}{\partial t}(x(X), t) + \mathbf{u}(x(X), t) \cdot \nabla f(x(X), t) \right) J(X, t) dX \\ &= \int_{\Omega(t)} \left( \frac{\partial f}{\partial t}(x, t) + \mathbf{u}(x, t) \cdot \nabla f(x, t) \right) dx. \end{aligned} \quad (1.8)$$

Identity (1.6) now follows from the relations (1.7)–(1.8) and Euler's formula given by:

$$\frac{d}{dt} J(X, t) = \operatorname{div} \mathbf{u}(x(X, t), t) J(X, t). \quad (1.9)$$

The fluid is incompressible if for any domain  $\Omega(0)$  and any time  $t$ , there holds the identity

$$\operatorname{vol}(\Omega(t)) = \operatorname{vol}(\Omega(0)).$$



Taking  $f(x, t) \equiv 1$  and using (1.7), we have

$$\frac{d}{dt} \text{vol}(\Omega(t)) = \frac{d}{dt} \int_{\Omega(t)} dx = \int_{\Omega(0)} \frac{d}{dt} J(x, t) dX.$$

Now, using relations (1.2), (1.9), and the arbitrariness of the choice of the domain  $\Omega(t)$  via  $\Omega(0)$ , a necessary and sufficient condition for the fluid to be incompressible reads:

$$\text{div} \mathbf{u}(x, t) = 0.$$

### 1.1.3 Continuity Equation

Let  $\rho = \rho(x, t)$  be the mass per unit of a fluid at point  $x$  and time  $t$ . Then the mass of any finite volume  $\Omega$  is given by

$$m = \int_{\Omega} \rho(x, t) dx.$$

The principle of conservation of mass states that the mass of a fluid in a material volume  $\Omega$  does not change as  $\Omega$  moves with the fluid, namely:

$$\frac{d}{dt} \int_{\Omega(t)} \rho(x, t) dx = 0.$$

The transport theorem identity (1.6) now implies that

$$\int_{\Omega(t)} \left( \frac{\partial \rho}{\partial t} + \text{div}(\rho \mathbf{u}) \right) dx = 0. \quad (1.10)$$

We now obtain from (1.10) the following identity:

$$\frac{\partial \rho}{\partial t} + \text{div}(\rho \mathbf{u}) = 0. \quad (1.11)$$

Let now  $\Omega$  be a fixed volume. The principle of conservation of mass can also be expressed in the following form:

$$\frac{d}{dt} \int_{\Omega} \rho(x, t) dx = - \int_{\partial \Omega} \rho \mathbf{u} \cdot \mathbf{n} dS,$$

meaning that the rate of change of mass in a fixed volume  $\Omega$  is equal to the mass flux through its surface.

Finally, we also note that there holds the more general identity:

$$\frac{d}{dt} \int_{\Omega(t)} \rho f dx = \int_{\Omega(t)} \rho \frac{D}{Dt} f dx, \quad (1.12)$$

which will be useful in further considerations.

## 1.2 Dynamics

### 1.2.1 Principle of Conservation of Linear Momentum

The external force per unit mass, denoted by  $\mathbf{f}$ , acts on an element  $\Omega$  as

$$\int_{\Omega} \rho \mathbf{f} dx.$$

Let now  $\mathbf{n}$  be the unit outward normal at a point of the surface  $\partial\Omega$  and  $\mathbf{t}_n$  the force per unit area exerted there by the material volume outside  $\partial\Omega$ . The surface force exerted on the volume  $\Omega$  can then be expressed as

$$\int_{\partial\Omega} \mathbf{t}_n dS.$$

The Cauchy principle states that  $\mathbf{t}_n$  depends at any given time only on the position and the orientation of the surface element  $dS$ , namely

$$\mathbf{t}_n = \mathbf{t}_n(x, t, \mathbf{n}).$$

The principle of conservation of angular momentum claims that the rate of change of linear momentum of a material volume equals to the resultant force on the volume, expressed by the following identity:

$$\frac{d}{dt} \int_{\Omega(t)} \rho \mathbf{u} dx = \int_{\Omega(t)} \rho \mathbf{f} dx + \int_{\partial\Omega(t)} \mathbf{t}_n dS, \quad (1.13)$$

where  $\mathbf{f}$  is a given external force function.

Now, using (1.12) and the above identity (1.13), we obtain:

$$\int_{\Omega(t)} \rho \frac{D\mathbf{u}}{Dt} dx = \int_{\Omega(t)} \rho \mathbf{f} dx + \int_{\partial\Omega} \mathbf{t}_n dS. \quad (1.14)$$

It now easily follows that the normal stress  $\mathbf{t}_n$  can be expressed as a linear function of  $\mathbf{n}$ :

$$\mathbf{t}_n(x, t, \mathbf{n}) = \mathbf{n}(x, t)T(x, t),$$

where  $T = \{T^{ij}\}$  is the stress tensor.

Therefore, using Green's theorem in identity (1.14), we get

$$\int_{\Omega(t)} \rho \frac{D\mathbf{u}}{Dt} dx = \int_{\Omega(t)} (\rho \mathbf{f} + \operatorname{div} T) dx,$$

and, due to the arbitrariness of the domain of integration, it follows:

$$\rho \frac{D\mathbf{u}}{Dt} = \rho \mathbf{f} + \operatorname{div} T. \quad (1.15)$$

The general Cauchy's equation of motion (1.15) in differential form thus reads:

$$\rho \left( \frac{\partial}{\partial t} u^i + \sum_{j=1}^3 u^j \frac{\partial}{\partial x_j} u^i \right) = \rho f^i + T^{ji,j}, \quad i = 1, 2, 3.$$

It should be emphasized that, in classical fluid dynamics, it is assumed that the stress tensor is symmetric, namely

$$T^{ij} = T^{ji}.$$

## 1.2.2 Conservation of Angular Momentum

### Ordinary Fluids

Let us now recall the equation of conservation of linear momentum (1.13):

$$\frac{d}{dt} \int_{\Omega(t)} \rho \mathbf{u} dx = \int_{\Omega(t)} \rho \mathbf{f} dx + \int_{\partial\Omega(t)} \mathbf{t}_n dS.$$

Now, using the definition of angular momentum in mechanics of mass points or rigid particles, it is natural to assume the law of conservation of angular momentum in the following form:

$$\frac{d}{dt} \int_{\Omega(t)} \rho (x \times \mathbf{u}) dx = \int_{\Omega(t)} \rho (x \times \mathbf{f}) dx + \int_{\partial\Omega(t)} x \times \mathbf{t}_n dS. \quad (1.16)$$

**Theorem 1.1** (Symmetry of the stress tensor).

*For an arbitrary continuous medium satisfying the continuity equation (1.11) and the dynamical equation (1.15), the following statements are equivalent:*

- (i) *The stress tensor  $T$  is symmetric.*
- (ii) *Equation (1.16) holds.*

*Proof.* Let us first assume (ii) and deduce (i). Using identity (1.12) in (1.16), we obtain:

$$\begin{aligned} \frac{d}{dt} \int_{\Omega(t)} \rho (x \times \mathbf{u}) dx &= \int_{\Omega(t)} \rho \frac{D}{Dt} (x \times \mathbf{u}) dx = \int_{\Omega(t)} \rho \left( x \times \frac{D\mathbf{u}}{Dt} \right) dx \\ &= \int_{\Omega(t)} \rho (x \times \mathbf{f}) dx + \int_{\partial\Omega(t)} x \times \mathbf{t}_n dS. \end{aligned} \quad (1.17)$$

Applying Green's theorem, we have the identity:

$$\int_{\partial\Omega(t)} x \times \mathbf{t}_n dS = \int_{\Omega(t)} (x \times (\operatorname{div} T) + T_x) dx, \quad (1.18)$$

where  $T_x$  is the vector  $\epsilon^{ijk}T^{jk}$  ( $\epsilon^{ijk}$  is the alternating tensor of Levi–Civita, see [19]). Now, from (1.17) and (1.18) there follows:

$$\int_{\Omega(t)} x \times \left( \rho \frac{D\mathbf{u}}{Dt} - \rho \mathbf{f} - \operatorname{div}T \right) dx = \int_{\Omega(t)} T_x dx.$$

The left–hand side vanishes as there holds the Cauchy equation (1.15). This implies that the right–hand side vanishes for an arbitrary volume, and it follows that  $T_x = 0$ . Now, since the components of  $T_x$  are equal to  $T^{23} - T^{32}, T^{31} - T^{13}, T^{12} - T^{21}$ , the vanishing of  $T_x$  implies  $T^{ij} = T^{ji}$ , and  $T$  is symmetric.

It is now easy to check that (i) implies (ii). □

### Polar Fluids

To describe polar fluids, in addition to the body force  $\mathbf{f}$  and normal stress  $\mathbf{t}_n$ , we must introduce the body torque per unit mass  $\mathbf{g}$  and couple stress  $\mathbf{c}_n$ . The angular momentum now consists of the external angular momentum (moment of linear momentum)  $\rho x \times \mathbf{u}$  and internal angular momentum  $\rho \mathbf{l}$ .

The balance of total angular momentum now reads:

$$\frac{d}{dt} \int_{\Omega(t)} \rho (\mathbf{l} + x \times \mathbf{u}) dx = \int_{\Omega(t)} \rho (\mathbf{g} + x \times \mathbf{f}) dx + \int_{\partial\Omega(t)} (\mathbf{c}_n + x \times \mathbf{t}_n) dS. \quad (1.19)$$

As with  $\mathbf{t}_n$ , we can write  $\mathbf{c}_n$  in the form  $\mathbf{n} \times C$  (where  $C$  is the couple stress tensor). Using Green’s theorem in (1.19), we obtain:

$$\frac{d}{dt} \int_{\Omega(t)} \rho (\mathbf{l} + x \times \mathbf{u}) dx = \int_{\Omega(t)} (\rho \mathbf{g} + \rho x \times \mathbf{f} + \operatorname{div}C + x \times \operatorname{div}T + T_x) dx. \quad (1.20)$$

Due to the arbitrariness of  $\Omega(t)$ , we can write equation (1.20) for the total angular momentum in the following way:

$$\rho \frac{D}{Dt} (\mathbf{l} + x \times \mathbf{u}) = \rho \mathbf{g} + \rho x \times \mathbf{f} + \operatorname{div}C + x \times (\operatorname{div}T) + T_x. \quad (1.21)$$

From Cauchy’s equation (1.15), we now obtain the identity

$$\rho \left( x \times \frac{D\mathbf{u}}{Dt} \right) = \rho \frac{D}{Dt} (x \times \mathbf{u}) = \rho x \times \mathbf{f} + x \times \operatorname{div}T. \quad (1.22)$$

Now, subtracting (1.21) and (1.22), we obtain:

$$\rho \frac{D\mathbf{l}}{Dt} = \rho \mathbf{g} + \operatorname{div}C + T_x. \quad (1.23)$$

Employing the relation

$$\operatorname{div}(x \times T) = x \times (\operatorname{div}T) + T_x,$$

in (1.21) and (1.22), we get

$$\rho \frac{D}{Dt}(x \times \mathbf{u}) = \rho x \times \mathbf{f} + \operatorname{div}(x \times T) - T_x,$$

and

$$\rho \frac{D}{Dt}(l + x \times \mathbf{u}) = \rho x \times \mathbf{f} + \rho \mathbf{g} + \operatorname{div}(x \times T + C), \quad (1.24)$$

where the law of conservation of (total) angular momentum in differential form is given by the above equation (1.24).

In the sequel, we shall assume that the internal angular momentum per unit mass can be written as a vector with components  $l^i$  ( $i = 1, 2, 3$ ), where  $l^i = I^{ik} \mathbf{w}^k$ , and consider isotropic fluids such that the following holds:

$$I^{ik} = I \delta^{ik}.$$

Here  $I$  is a scalar called the microinertia coefficient. Equation (1.23) for isotropic polar fluids reduces to

$$\rho I \frac{D\mathbf{w}}{Dt} = \rho \mathbf{g} + \operatorname{div}C + T_x, \quad (1.25)$$

where the vector field  $\mathbf{w}$  is called the microrotation field representing the angular velocity of the rotation of particles of the fluid.

### 1.2.3 Energy Equation

The first law of thermodynamics states that the increase in total energy in a material volume is the sum of the transferred heat and the work done on the volume.

The balance expressed by the first law of thermodynamics is given by

$$\frac{d}{dt} \int_{\Omega(t)} \rho \left( \frac{1}{2} |\mathbf{u}|^2 + E \right) dx = \int_{\Omega(t)} \rho \mathbf{f} \cdot \mathbf{u} dx + \int_{\partial\Omega(t)} \mathbf{t}_n \cdot \mathbf{u} dS - \int_{\partial\Omega(t)} \mathbf{q} \cdot \mathbf{n} dS, \quad (1.26)$$

where  $E$  is the specific internal energy and  $\mathbf{q}$  is the heat flux. The first integral on the right hand side in (1.26) is the rate at which the body force does work, the second integral represents the work done by the stress and the third integral is the total heat flux into the volume.

From the relation

$$\int_{\partial\Omega(t)} u^i T^{ji} n^j dS = \int_{\Omega(t)} \left( T^{ji} u^{i,j} + \rho u^i \frac{Du^i}{Dt} - \rho f^i u^i \right),$$

using transport theorem (1.6), we obtain the identity

$$\frac{d}{dt} \int_{\Omega(t)} \rho \frac{1}{2} |\mathbf{u}|^2 = \int_{\Omega(t)} \rho \frac{1}{2} \frac{D}{Dt} |\mathbf{u}|^2 dx = \int_{\Omega(t)} \rho f^i u^i dx - \int_{\Omega(t)} T^{ji} u^{i,j} dx + \int_{\partial\Omega(t)} u^i (\mathbf{t}_n)^i dS. \quad (1.27)$$

Now, from (1.26), (1.27), the transport theorem (1.6) and Green's theorem, we have

$$\int_{\Omega(t)} \left( \rho \frac{DE}{Dt} + \operatorname{div} \mathbf{q} - T:(\nabla \mathbf{u}) \right) dx = 0,$$

where  $T:(\nabla \mathbf{u})$  is the dyadic notation for  $T^{ji} u^{i,j}$ , the scalar product of  $T$  and  $\nabla \mathbf{u}$ .

Finally, we obtain

$$\rho \frac{DE}{Dt} = -\operatorname{div} \mathbf{q} + T:(\nabla \mathbf{u}). \quad (1.28)$$

Now, assuming Fourier's law for heat conduction

$$\mathbf{q} = -k \nabla \theta, \quad (1.29)$$

where  $k \geq 0$ , the energy equation (1.28) becomes

$$\rho \frac{DE}{Dt} = \operatorname{div}(k \nabla \theta) + T:(\nabla \mathbf{u}).$$

In the case of isotropic polar fluids, we shall consider the first law of thermodynamics given by

$$\begin{aligned} \frac{d}{dt} \int_{\Omega(t)} \rho \left( \frac{|\mathbf{u}|^2}{2} + I \frac{|\mathbf{w}|^2}{2} + E \right) dx &= \int_{\Omega(t)} (\rho \mathbf{u} \cdot \mathbf{f} + \rho \mathbf{w} \cdot \mathbf{g}) dx \\ &+ \int_{\Omega(t)} \mathbf{t}_n \cdot \mathbf{u} dS + \int_{\Omega(t)} \mathbf{c}_n \cdot \mathbf{w} dS - \int_{\Omega(t)} \mathbf{q} \cdot \mathbf{n} dS, \end{aligned}$$

which can be written in the following way using (1.15) and (1.25):

$$\rho \frac{DE}{Dt} = -\operatorname{div} \mathbf{q} + T:(\nabla \mathbf{u}) + C:(\nabla \mathbf{w}) - T_x \cdot \mathbf{w}.$$

## 1.3 Micropolar fluids

### 1.3.1 Isotropic Polar Fluids

We now write the laws of conservation of mass, linear momentum, angular momentum and energy derived in the previous sections for isotropic polar fluids as:

$$\begin{aligned}\frac{D\rho}{Dt} &= -\rho \operatorname{div} \mathbf{u}, & \rho \frac{D\mathbf{u}}{Dt} &= \operatorname{div} T + \rho \mathbf{f}, \\ \rho I \frac{D\mathbf{w}}{Dt} &= \operatorname{div} C + \rho \mathbf{g} + T_x, \\ \rho \frac{DE}{Dt} &= -\operatorname{div} \mathbf{q} + T:(\nabla \mathbf{u}) + C:(\nabla \mathbf{w}) - T_x \cdot \mathbf{w}.\end{aligned}\tag{1.30}$$

In classical hydrodynamics, there holds  $C = 0$  and  $\mathbf{g} = \mathbf{w} = 0$ , so from (1.30)<sub>2</sub> we obtain the symmetry of the stress tensor  $T_x$ . The system of equations (1.30) then reduces to:

$$\begin{aligned}\frac{D\rho}{Dt} &= -\rho \operatorname{div} \mathbf{u}, & \rho \frac{D\mathbf{u}}{Dt} &= \operatorname{div} T + \rho \mathbf{f}, \\ \rho \frac{DE}{Dt} &= -\operatorname{div} \mathbf{q} + T:(\nabla \mathbf{u}).\end{aligned}$$

We conclude that the model of isotropic polar fluids contains as a particular case the classical Navier–Stokes model, which can be obtained from (1.30) by putting  $C = 0$ ,  $\mathbf{g} = \mathbf{w} = 0$  and defining the stress tensor  $T$  as

$$T^{ij} = (-p + \lambda u^{k,k}) \delta_{ij} + \nu (u^{i,j} + u^{j,i}).\tag{1.31}$$

The above identity (1.31) can be derived from a number of postulates concerning the fundamental properties of fluids.

### 1.3.2 Constitutive Equations for Micropolar Fluids

A micropolar fluid is defined as a polar isotropic fluid with stress tensor  $T$  and couple stress tensor  $C$  given by

$$T^{ij} = (-p + \lambda u^{k,k}) \delta_{ij} + \nu (u^{i,j} + u^{j,i}) + \nu_r (u^{j,i} - u^{i,j}) - 2\nu_r \epsilon^{mij} w^m,\tag{1.32}$$

and

$$C^{ij} = c_0 w^{k,k} \delta_{ij} + c_d (w^{i,j} + w^{j,i}) + c_a (w^{j,i} - w^{i,j}).\tag{1.33}$$

The symmetric part of the stress tensor  $T$  in (1.32) is

$$T_{(s)}^{ij} = (-p + \lambda u^{k,k}) \delta_{ij} + \nu (u^{i,j} + u^{j,i}),$$

which is the stress tensor of classical hydrodynamics, where  $\lambda$  and  $\nu$  are the usual viscosity coefficients ( $\lambda$  is the second viscosity coefficient and  $\nu$  is the dynamic Newtonian viscosity) satisfying  $\nu \geq 0$  and  $3\lambda + 2\nu \geq 0$ .

The positive constant  $\nu_r$  in (1.32) represents the dynamic microrotation viscosity, while the constants  $c_0, c_a$  and  $c_d$  in (1.33) are called the coefficients of angular viscosities.

Substituting the stress tensor  $T$  and couple stress tensor  $C$  given by (1.32) and (1.33) into the system of equations (1.30), we obtain the following:

$$\begin{aligned} \frac{D\rho}{Dt} &= -\rho \operatorname{div} \mathbf{u}, \\ \rho \frac{D\mathbf{u}}{Dt} &= -\nabla p + (\lambda + \nu - \nu_r) \nabla \operatorname{div} \mathbf{u} + (\nu + \nu_r) \Delta \mathbf{u} + 2\nu_r \operatorname{rot} \mathbf{w} + \rho \mathbf{f}, \\ \rho I \frac{D\mathbf{w}}{Dt} &= 2\nu_r (\operatorname{rot} \mathbf{u} - 2\mathbf{w}) + (c_0 + c_d - c_a) \nabla \operatorname{div} \mathbf{w} + (c_a + c_d) \Delta \mathbf{w} + \rho \mathbf{g}, \\ \rho \frac{DE}{Dt} &= -p \operatorname{div} \mathbf{u} \rho \Phi - \operatorname{div} \mathbf{q}, \end{aligned} \tag{1.34}$$

where

$$\rho \Phi = \lambda (\operatorname{div} \mathbf{u})^2 + 2\nu D:D + 4\nu_r \left( \frac{1}{2} \operatorname{rot} \mathbf{u} - \mathbf{w} \right)^2 + c_0 (\operatorname{div} \mathbf{w})^2 + (c_a + c_d) \nabla \mathbf{w} : \mathbf{w} + (c_d - c_a) \nabla \mathbf{w} : (\nabla \mathbf{w})^t, \tag{1.35}$$

and  $D$  is the deformation tensor given as

$$D^{ij} = \frac{1}{2} (u^{i,j} + u^{j,i}).$$

We observe that if  $\mathbf{g}, \mathbf{w}$  and  $\nu_r, c_0, c_a, c_d$  are equal to zero, the above system (1.34) reduces to the system of field equations of classical hydrodynamics:

$$\begin{aligned} \frac{D\rho}{Dt} &= -\rho \operatorname{div} \mathbf{u}, \\ \rho \frac{D\mathbf{u}}{Dt} &= -\nabla p + (\lambda + \nu - \nu_r) \nabla \operatorname{div} \mathbf{u} + (\nu + \nu_r) \Delta \mathbf{u} + 2\nu_r \operatorname{rot} \mathbf{w} + \rho \mathbf{f}, \\ \rho \frac{DE}{Dt} &= -p \operatorname{div} \mathbf{u} \rho \Phi - \operatorname{div} \mathbf{q}, \end{aligned}$$

where

$$\rho \Phi = \lambda (\operatorname{div} \mathbf{u})^2 + 2\nu D:D.$$

### 1.3.3 Micropolar Field Equations

We assume the fluid is viscous and incompressible, meaning that  $\nu > 0$  and

$$\operatorname{div} \mathbf{u} = 0, \tag{1.36}$$



that the specific internal energy of the fluid is proportional to its temperature

$$E = c_r \theta, \quad (1.37)$$

where  $c_r$  is a positive constant and that there holds the Fourier's law (1.29).

Now, taking into account (1.36), (1.37), (1.35) and (1.29), the system (1.34) becomes:

$$\begin{aligned} \frac{\partial \rho}{\partial t} + \mathbf{u} \cdot \nabla \rho &= 0, \\ \operatorname{div} \mathbf{u} &= 0, \\ \rho \left( \frac{\partial \mathbf{u}}{\partial t} + (\mathbf{u} \cdot \nabla) \mathbf{u} \right) &= -\nabla p + (\nu + \nu_r) \Delta \mathbf{u} + 2\nu_r \operatorname{rot} \mathbf{w} + \rho \mathbf{f}, \\ \rho I \left( \frac{\partial \mathbf{w}}{\partial t} + (\mathbf{u} \cdot \nabla) \mathbf{w} \right) &= 2\nu_r (\operatorname{rot} \mathbf{u} - 2\mathbf{w}) + (c_0 + c_d - c_a) \nabla \operatorname{div} \mathbf{w} + (c_a + c_d) \Delta \mathbf{w} + \rho \mathbf{g}, \\ \rho c_r \left( \frac{\partial \theta}{\partial t} + \mathbf{u} \cdot \nabla \theta \right) &= 2\nu D:D + 4\mu_r \left( \frac{1}{2} \operatorname{rot} \mathbf{u} - \mathbf{w} \right)^2 + c_0 (\operatorname{div} \mathbf{w})^2 \\ &\quad + (c_a + c_d) \nabla \mathbf{w} : \nabla \mathbf{w} + (c_d - c_a) \nabla \mathbf{w} : (\nabla \mathbf{w})^t. \end{aligned}$$

In the rest of the dissertation, we will consider an isothermal micropolar fluid flow with  $\rho = I = 1$ , that is, the system of equations:

$$\begin{aligned} \frac{\partial \mathbf{u}}{\partial t} + (\mathbf{u} \cdot \nabla) \mathbf{u} &= -\nabla p + (\nu + \nu_r) \Delta \mathbf{u} + 2\nu_r \operatorname{rot} \mathbf{w} + \mathbf{f}, \\ \operatorname{div} \mathbf{u} &= 0, \\ \frac{\partial \mathbf{w}}{\partial t} + (\mathbf{u} \cdot \nabla) \mathbf{w} &= 2\nu_r (\operatorname{rot} \mathbf{u} - 2\mathbf{w}) + (c_0 + c_d - c_a) \nabla \operatorname{div} \mathbf{w} + (c_a + c_d) \Delta \mathbf{w} + \mathbf{g}, \end{aligned}$$

endowed with the appropriate initial and boundary conditions.

## Chapter 2

# Existence and Uniqueness of the Generalized Nonsteady Micropolar Poiseuille Solution

In this Chapter, we consider the nonsteady flow of a micropolar fluid through an infinite cylinder with a prescribed flux. The results on classical Newtonian flow are provided by K. Pileckas (see [33]). More precisely, the existence of the standard nonsteady Poiseuille solution in an infinite cylinder  $\Omega = \{x = (x_1, x') \in \mathbb{R}^3 : x_1 \in \mathbb{R}, x' = (x_1, x_2) \in \sigma\}$  has been brought in [35] in Hölder spaces (see also [34] investigating the asymptotic behavior of the Poiseuille solution as  $t \rightarrow \infty$ ). In [32], Pileckas has considered a generalized time-dependent Poiseuille flow in  $\Omega$  by assuming that the solution  $(\mathbf{u}, p)$  has the following form:

$$\begin{aligned}\mathbf{u}(x, t) &= (u^1(x', t), u^2(x', t), u^3(x', t)), \\ p(x, t) &= \hat{p}(x', t) - q(t)x_3 + p_0(t),\end{aligned}$$

where  $p_0(t)$  is an arbitrary function of time. The solvability of such problem in Sobolev spaces has been established by constructing the Galerkin approximations of the solution.

Following [5], we present the generalization of this result for the micropolar setting, i.e. we prove the global existence and uniqueness result for the generalized nonsteady micropolar Poiseuille solution. In view of that, this Chapter is organized as follows. First, in Section 2.1, we write the micropolar equations, suppose that the solution is of general micropolar Poiseuille form and then decompose the problem, obtaining the classical 2D micropolar problem and the micropolar inverse problem. The existence of the unique solution for the 2D micropolar problem is addressed in Section 2.2, following [21]. In Section 2.3, we deduce the existence of the micropolar inverse problem by semidiscretization in time, proving the existence of the unique solution of the discrete problem, deriving a-priori

estimates for the discrete approximations, using the compactness method and treating the case  $T = \infty$ . In Section 2.4, we address the existence and uniqueness of the solution to the original coupled problem for  $T \in \langle 0, \infty \rangle$ . Finally, in Section 2.5 we present a discussion on the solvability of parabolic systems in Hilbert spaces.

Let us provide a few more bibliographic remarks. In [37], the author has proved the existence of weak solutions to the initial boundary value problem for incompressible micropolar fluids in the absence of body forces and moments and with homogeneous Dirichlet boundary conditions. In [39], the existence and uniqueness of a global solution for micropolar fluid equations has been established with periodic boundary conditions and with external forces and moments independent of the longitudinal coordinate  $x_1$ . Local-in-time existence and uniqueness of strong solutions for the incompressible micropolar fluid equations in bounded or unbounded domains of  $\mathbb{R}^3$  has been established in [7]. The micropolar Poiseuille solution has been employed in [38] for the purpose of studying the steady micropolar Leray problem.

## 2.1 Micropolar Equations

We consider an infinite cylinder  $\Omega = \{x \in \mathbb{R}^3: x_1 \in \mathbb{R}, x' = (x_2, x_3) \in \sigma\}$ , where  $\sigma$  is a bounded open set of class  $\mathcal{C}^2$  in  $\mathbb{R}^2$ . We denote the Cartesian coordinates  $x = (x_1, (x_2, x_3)) \equiv (x_1, x')$ , with  $x_1$  being the direction coinciding with the axis of the cylinder. We consider the initial boundary value problem for the nonsteady micropolar fluid flow in an infinite cylinder  $\Omega$ :

$$\begin{aligned} \frac{\partial \mathbf{u}}{\partial t} - (\nu + \nu_r)\Delta \mathbf{u} + (\mathbf{u} \cdot \nabla)\mathbf{u} + \nabla p &= 2\nu_r \text{rot } \mathbf{w} + \mathbf{f}, \\ \text{div } \mathbf{u} &= 0, \end{aligned} \quad (2.1)$$

$$\frac{\partial \mathbf{w}}{\partial t} - (c_a + c_d)\Delta \mathbf{w} + (\mathbf{u} \cdot \nabla)\mathbf{w} - (c_0 + c_d - c_a)\nabla \text{div } \mathbf{w} + 4\nu_r \mathbf{w} = 2\nu_r \text{rot } \mathbf{u} + \mathbf{g},$$

with the boundary and initial conditions

$$\mathbf{u}|_{\partial\Omega} = \mathbf{0}, \quad \mathbf{w}|_{\partial\Omega} = \mathbf{0}, \quad (2.2)$$

and

$$\mathbf{u}(x, 0) = \mathbf{a}(x), \quad \mathbf{w}(x, 0) = \mathbf{b}(x), \quad (2.3)$$

along with the flux condition with the given flow rate  $F(t)$

$$\int_{\sigma} u^1(x_1, x', t) dx' = F(t). \quad (2.4)$$

Here  $\mathbf{u}(x_1, x', t) = (u^1(x_1, x', t), u^2(x_1, x', t), u^3(x_1, x', t))$  stands for the velocity field,  $\mathbf{w}(x_1, x', t) = (w^1(x_1, x', t), w^2(x_1, x', t), w^3(x_1, x', t))$  is the angular velocity of rotation of the fluid particles (the microrotation field), while  $p(x_1, x', t)$  is the pressure. The positive constants are the Newtonian viscosity  $\nu$ , the microrotation viscosity  $\nu_r$ , while  $c_0, c_a$  and  $c_d$  are coefficients of angular viscosities. The external sources of linear and angular momentum are given with functions  $\mathbf{f} = (f^1, f^2, f^3)$  and  $\mathbf{g} = (g^1, g^2, g^3)$ , respectively. We assume that the nonsteady solution of the problem (2.1)–(2.4) has the generalized Poiseuille form

$$\mathbf{u}(x, t) = (u^1(x', t), u^2(x', t), u^3(x', t)), \quad (2.5)$$

$$\mathbf{w}(x, t) = (w^1(x', t), w^2(x', t), w^3(x', t)), \quad (2.6)$$

$$p(x, t) = \hat{p}(x', t) - q(t)x_1 + p_0(t), \quad (2.7)$$

where  $p_0(t)$  is an arbitrary function in  $t$ . We also assume that

$$\mathbf{a}(x) = (a^1(x'), a^1(x'), a^3(x')),$$

$$\mathbf{b}(x) = (b^1(x'), b^2(x'), b^3(x')),$$

$$\mathbf{f}(x, t) = (f^1(x', t), f^2(x', t), f^3(x', t)),$$

$$\mathbf{g}(x, t) = (g^1(x', t), g^2(x', t), g^3(x', t)),$$

are independent of  $x_1$  and that there holds the necessary compatibility condition

$$\int_{\sigma} a^1(x') dx' = F(0).$$

In order to formulate the resulting problem in a more compact form we introduce the following notation:  $\hat{\mathbf{u}}(x', t) = (u^2(x', t), u^3(x', t))$ ,  $\hat{\mathbf{a}}(x') = (a^2(x'), a^3(x'))$ ,  $\hat{\mathbf{f}}(x', t) = (f^2(x', t), f^3(x', t))$ ,  $\omega(x', t) = w^1(x', t)$ ,  $b(x') = b^1(x')$ ,  $v(x', t) = u^1(x', t)$ ,  $a(x') = a^1(x')$ ,  $f(x', t) = f^1(x', t)$ ,  $\hat{\mathbf{w}}(x', t) = (w^2(x', t), w^3(x', t))$ ,  $\hat{\mathbf{b}}(x') = (b^2(x'), b^3(x'))$  and  $\hat{\mathbf{g}}(x', t) = (g^2(x', t), g^3(x', t))$ ,  $g(x', t) = g^1(x', t)$ . Furthermore, from now on, we denote

$$\begin{aligned} \operatorname{rot}_{x'} \boldsymbol{\phi} &= \frac{\partial \phi^3}{\partial x_2} - \frac{\partial \phi^2}{\partial x_3}, & \operatorname{div}_{x'} \boldsymbol{\phi} &= \frac{\partial \phi^2}{\partial x_2} + \frac{\partial \phi^3}{\partial x_3}, & \nabla_{x'}^{\perp} \phi &= \left( \frac{\partial \phi}{\partial x_3}, -\frac{\partial \phi}{\partial x_2} \right), \\ \Delta_{x'} \phi &= \frac{\partial^2 \phi}{\partial x_2^2} + \frac{\partial^2 \phi}{\partial x_3^2}, & \nabla_{x'} \phi &= \left( \frac{\partial \phi}{\partial x_2}, \frac{\partial \phi}{\partial x_3} \right), \end{aligned}$$

for any sufficiently smooth scalar function  $\phi$  and a vector function  $\boldsymbol{\phi} = (\phi^2, \phi^3)$ .

Taking the generalized Poiseuille solution (2.5)–(2.7), plugging it into the system (2.1)–(2.4), and decomposing the obtained system of equations we get the following two problems set on the cross-section  $\sigma$ :

$$\begin{aligned} \frac{\partial \hat{\mathbf{u}}}{\partial t} - (\nu + \nu_r)\Delta_{x'}\hat{\mathbf{u}} + (\hat{\mathbf{u}} \cdot \nabla_{x'})\hat{\mathbf{u}} + \nabla_{x'}\hat{p} &= 2\nu_r\nabla_{x'}^\perp\omega + \hat{\mathbf{f}}, \\ \nabla_{x'} \cdot \hat{\mathbf{u}} &= 0, \\ \frac{\partial \omega}{\partial t} - (c_a + c_d)\Delta_{x'}\omega + (\hat{\mathbf{u}} \cdot \nabla_{x'})\omega + 4\nu_r\omega &= 2\nu_r\text{rot}_{x'}\hat{\mathbf{u}} + g, \\ \hat{\mathbf{u}}(x', t)|_{\partial\sigma} &= \mathbf{0}, \quad \omega(x', t)|_{\partial\sigma} = 0, \\ \hat{\mathbf{u}}(x', 0) &= \hat{\mathbf{a}}(x'), \quad \omega(x', 0) = b(x'), \end{aligned} \quad (2.8)$$

and

$$\begin{aligned} \frac{\partial v}{\partial t} - (\nu + \nu_r)\Delta_{x'}v + (\hat{\mathbf{u}} \cdot \nabla_{x'})v - q(t) &= 2\nu_r\text{rot}_{x'}\hat{\mathbf{w}} + f, \\ \frac{\partial \hat{\mathbf{w}}}{\partial t} - (c_a + c_d)\Delta_{x'}\hat{\mathbf{w}} + (\hat{\mathbf{u}} \cdot \nabla_{x'})\hat{\mathbf{w}} - (c_0 + c_d - c_a)\nabla_{x'}\text{div}_{x'}\hat{\mathbf{w}} + 4\nu_r\hat{\mathbf{w}} &= 2\nu_r\nabla_{x'}^\perp v + \hat{\mathbf{g}}, \\ v|_{\partial\sigma} &= 0, \quad \hat{\mathbf{w}}|_{\partial\sigma} = \mathbf{0}, \\ v(x', 0) &= a(x'), \quad \hat{\mathbf{w}}(x', 0) = \hat{\mathbf{b}}(x'). \end{aligned} \quad (2.9)$$

The system (2.9) is completed with the flux condition

$$\int_{\sigma} v(x', t)dx' = F(t). \quad (2.10)$$

Let  $\tilde{V} := \{\boldsymbol{\phi} \in C_0^\infty(\sigma)^2; \boldsymbol{\phi} = (\phi_1, \phi_2), \text{div } \boldsymbol{\phi} = 0 \text{ in } \sigma\}$ . Let the linear space  $V$  and  $H$ , respectively, be closures of  $\tilde{V}$  in the norm of  $W^{1,2}(\sigma)^2$  and  $L^2(\sigma)^2$ . To simplify mathematical formulations we introduce the following notations:

$$a(\boldsymbol{\phi}, \boldsymbol{\psi}) := \int_{\sigma} \frac{\partial \phi_i}{\partial x_j} \frac{\partial \psi_i}{\partial x_j} dx', \quad (2.11)$$

$$b(\boldsymbol{\phi}, \boldsymbol{\psi}, \boldsymbol{\varphi}) := \int_{\sigma} \phi_j \frac{\partial \psi_i}{\partial x_j} \varphi_i dx', \quad (2.12)$$

$$d(\boldsymbol{\phi}, \boldsymbol{\psi}, \boldsymbol{\varphi}) := \int_{\sigma} \phi_j \frac{\partial \psi}{\partial x_j} \varphi dx', \quad (2.13)$$

$$((\boldsymbol{\phi}, \boldsymbol{\psi})) := \int_{\sigma} \phi_i \psi_i dx', \quad (2.14)$$

$$(\boldsymbol{\psi}, \boldsymbol{\varphi}) := \int_{\sigma} \psi \varphi dx'. \quad (2.15)$$

In (2.11)–(2.15) all functions  $\boldsymbol{\phi}$ ,  $\boldsymbol{\psi}$ ,  $\boldsymbol{\varphi}$ ,  $\psi$  and  $\varphi$  are smooth enough, such that all integrals on the right-hand sides make sense.

## 2.2 Solvability of Problem (2.8)

In this section we will recall some well-known results concerning the existence, regularity and uniqueness for micropolar incompressible fluid flows in two-dimensional bounded domains. First, we introduce notions of weak solutions to the problem (2.8).

### Definition 2.1.

(i) Let  $T \in \langle 0, \infty \rangle$  and suppose that

$$\begin{aligned}\hat{\mathbf{f}} &\in L^2(0, T; H), \quad g \in L^2(0, T; L^2(\sigma)), \\ \hat{\mathbf{a}} &\in H, \quad b \in L^2(\sigma).\end{aligned}$$

By a weak solution of the problem (2.8) on  $\langle 0, T \rangle$  we mean a pair  $[\hat{\mathbf{u}}, \omega]$  such that

$$\begin{aligned}\hat{\mathbf{u}} &\in L^2(0, T; V) \cap C([0, T]; H), \\ \omega &\in L^2(0, T; W_0^{1,2}(\sigma)) \cap C([0, T]; L^2(\sigma)),\end{aligned}$$

and the following system

$$\frac{d}{dt}((\hat{\mathbf{u}}(t), \boldsymbol{\psi})) + (\nu + \nu_r)a(\hat{\mathbf{u}}(t), \boldsymbol{\psi}) + b(\hat{\mathbf{u}}(t), \hat{\mathbf{u}}(t), \boldsymbol{\psi}) = 2\nu_r((\nabla_x^\perp \omega(t), \boldsymbol{\psi})) + ((\hat{\mathbf{f}}(t), \boldsymbol{\psi})), \quad (2.16)$$

and

$$\begin{aligned}\frac{d}{dt}(\omega(t), \varphi) + (c_a + c_d)((\nabla \omega(t), \nabla \varphi)) + d(\hat{\mathbf{u}}(t), \omega(t), \varphi) + 4\nu_r(\omega(t), \varphi) \\ = 2\nu_r(\text{rot}_{x'} \hat{\mathbf{u}}(t), \varphi) + (g(t), \varphi),\end{aligned} \quad (2.17)$$

holds for every  $[\boldsymbol{\psi}, \varphi] \in V \times W_0^{1,2}(\sigma)$  in the sense of scalar distributions on  $\langle 0, T \rangle$  and

$$\hat{\mathbf{u}}(x', 0) = \hat{\mathbf{a}}(x') \quad \text{in } \sigma, \quad (2.18)$$

$$\omega(x', 0) = b(x') \quad \text{in } \sigma. \quad (2.19)$$

(ii) Let  $T = +\infty$  and suppose that  $\hat{\mathbf{f}} \in L^2(0, \infty; H)$ ,  $g \in L^2(0, \infty; L^2(\sigma))$ ,  $\hat{\mathbf{a}} \in H$  and  $b \in L^2(\sigma)$ . By a weak solution of the problem (2.8) on  $\langle 0, +\infty \rangle$  we mean a pair  $[\hat{\mathbf{u}}, \omega]$  such that  $\hat{\mathbf{u}} \in L^2(0, \infty; V) \cap C([0, \infty); H)$ ,  $\omega \in L^2(0, \infty; W_0^{1,2}(\sigma)) \cap C([0, \infty); L^2(\sigma))$ ,  $\hat{\mathbf{u}}(x', 0) = \hat{\mathbf{a}}(x')$ ,  $\omega(x', 0) = b(x')$  in  $\Omega$  and the system (2.16)–(2.17) holds for every  $[\boldsymbol{\psi}, \varphi] \in V \times W_0^{1,2}(\sigma)$  in the sense of scalar distributions on  $\langle 0, +\infty \rangle$ .

### Theorem 2.2 ([21, 37]).

There exists a unique solution of the problem (2.8) in the sense of Definition 2.1.

**Theorem 2.3** ([40]).

Let  $T \in \langle 0, +\infty \rangle$  and  $[\hat{\mathbf{u}}, \omega]$  be the solution of the problem (2.8) in the sense of Definition 2.1. In addition, let  $\hat{\mathbf{a}} \in V$  and  $b \in W_0^{1,2}(\sigma)$ . Then

$$\partial_t \hat{\mathbf{u}} \in L^2(0, T; H), \quad \hat{\mathbf{u}} \in L^2(0, T; W^{2,2}(\sigma)^2) \cap L^\infty(0, T; V), \quad (2.20)$$

$$\partial_t \omega \in L^2(0, T; L^2(\sigma)), \quad \omega \in L^2(0, T; W^{2,2}(\sigma)) \cap L^\infty(0, T; W_0^{1,2}(\sigma)). \quad (2.21)$$

*Proof.* Let  $[\hat{\mathbf{u}}, \omega]$  be the weak solution of the problem (2.8) in the sense of Definition 2.1. Then for the right hand side of (2.16) we have

$$2\nu_r \nabla_{x'}^\perp \omega + \hat{\mathbf{f}} \in L^2(0, T; H).$$

Assuming  $\hat{\mathbf{a}} \in V$ , (2.20) follows from [40, Chapter 3, Theorem 3.10]. Finally, (2.21) can be proved by similar arguments. □

## 2.3 Solvability of Problem (2.9)–(2.10)

**Definition 2.4.**

Let  $T \in \langle 0, \infty \rangle$  and suppose that

$$\hat{\mathbf{u}} \in L^2(0, T; W^{2,2}(\sigma)^2) \cap L^\infty(0, T; V), \quad (2.22)$$

$$\hat{\mathbf{g}} \in L^2(0, T; L^2(\sigma)^2), \quad f \in L^2(0, T; L^2(\sigma)), \quad F \in W^{1,2}(\langle 0, T \rangle), \quad (2.23)$$

$$\hat{\mathbf{b}} \in W_0^{1,2}(\sigma)^2, \quad a \in W_0^{1,2}(\sigma). \quad (2.24)$$

The weak solution of problem (2.9)–(2.10) is a triple  $[v, \hat{\mathbf{w}}, q]$  such that

$$v \in L^\infty(0, T; W_0^{1,2}(\sigma)) \cap W^{1,2}(0, T; L^2(\sigma)),$$

$$\hat{\mathbf{w}} \in L^\infty(0, T; W_0^{1,2}(\sigma)^2) \cap W^{1,2}(0, T; L^2(\sigma)^2),$$

$$q \in L^2(\langle 0, T \rangle),$$

$$v(x', 0) = a(x'), \quad \hat{\mathbf{w}}(x', 0) = \hat{\mathbf{b}}(x'), \quad (2.25)$$

and the following identities hold:

$$\begin{aligned} \frac{d}{dt}(v(t), \varphi) + (\nu + \nu_r)((\nabla_{x'} v(t), \nabla_{x'} \varphi)) + d(\hat{\mathbf{u}}(t), v(t), \varphi) \\ = q(t)(1, \varphi) + 2\nu_r(\text{rot } \hat{\mathbf{w}}(t), \varphi) + (f(t), \varphi), \end{aligned} \quad (2.26)$$

for all  $\varphi \in W_0^{1,2}(\sigma)$ ,

$$\begin{aligned} & \frac{d}{dt}((\hat{\mathbf{w}}(t), \boldsymbol{\psi})) + (c_a + c_d)a(\hat{\mathbf{w}}(t), \boldsymbol{\psi}) + b(\hat{\mathbf{u}}(t), \hat{\mathbf{w}}(t), \boldsymbol{\psi}) \\ & + (c_0 + c_d - c_a)(\operatorname{div}\hat{\mathbf{w}}(t), \operatorname{div}\boldsymbol{\psi}) + 4\nu_r((\hat{\mathbf{w}}(t), \boldsymbol{\psi})) = 2\nu_r((\nabla_{x'}^\perp v(t), \boldsymbol{\psi})) + ((\hat{\mathbf{g}}(t), \boldsymbol{\psi})), \end{aligned} \quad (2.27)$$

for all  $\boldsymbol{\psi} \in W_0^{1,2}(\sigma)^2$  and for almost every  $t \in \langle 0, T \rangle$ , and

$$\int_\sigma v(x', t) dx' = F(t), \quad \text{for almost every } t \in \langle 0, T \rangle. \quad (2.28)$$

### Theorem 2.5.

There exists a solution of the problem (2.9)–(2.10) in the sense of Definition 2.4.

The detailed proof of Theorem 2.5 is split into several steps.

#### 2.3.1 Discrete Approximations on $\langle 0, T \rangle$

Let  $T \in \langle 0, +\infty \rangle$ , fix  $n \in \mathbb{N}$  and let  $h := T/n$  be a time step. Furthermore, let us consider

$$\left. \begin{aligned} f_n^i(x') &:= \frac{1}{h} \int_{(i-1)h}^{ih} f(x', s) ds, & i = 1, \dots, n, \\ \mathbf{g}_n^i(x') &:= \frac{1}{h} \int_{(i-1)h}^{ih} \hat{\mathbf{g}}(x', s) ds, & i = 1, \dots, n, \\ \mathbf{u}_n^i(x') &:= \frac{1}{h} \int_{(i-1)h}^{ih} \hat{\mathbf{u}}(x', s) ds, & i = 1, \dots, n, \\ F_n^i &:= \frac{1}{h} \int_{(i-1)h}^{ih} F(s) ds, & i = 1, \dots, n, \\ \mathbf{w}_n^0(x') &:= \hat{\mathbf{b}}(x'), \\ v_n^0(x') &:= a(x') \end{aligned} \right\} \text{ a.e. in } \sigma.$$

First, note that, in view of (2.22), we have

$$\mathbf{u}_n^i \in W^{2,2}(\sigma)^2 \text{ and } h \sum_{i=1}^n \|\mathbf{u}_n^i\|_{W^{2,2}(\sigma)^2}^2 \leq C, \quad (2.29)$$

where  $C$  is independent of  $n$  (see [36, page 206, (8.28) and Lemma 8.7]) and by the Sobolev embedding we have

$$\|\mathbf{u}_n^i\|_{L^4(\sigma)^2} \leq c_1 \|\mathbf{u}_n^i\|_{W_0^{1,2}(\sigma)^2} \leq c_2, \quad (2.30)$$

with  $c_1$  and  $c_2$  independent of  $i$  and  $n$ . Further, by the Sobolev embedding and (2.29) we also have

$$\mathbf{u}_n^i \in L^\infty(\sigma)^2 \text{ and } h \sum_{i=1}^n \|\mathbf{u}_n^i\|_{L^\infty(\sigma)^2}^2 \leq C. \quad (2.31)$$

Now we are ready to approximate the evolution problem by an implicit time discretization scheme. Then we define, in each time step,  $[v_n^i, \mathbf{w}_n^i, q_n^i]$  as a solution of the following steady problem: for a given couple  $[v_n^{i-1}, \mathbf{w}_n^{i-1}] \in W_0^{1,2}(\sigma) \times W_0^{1,2}(\sigma)^2 \times \mathbb{R}$  find a triple



$[v_n^i, \mathbf{w}_n^i, q_n^i] \in W_0^{1,2}(\sigma) \times W_0^{1,2}(\sigma)^2 \times \mathbb{R}$ ,  $i = 1, \dots, n$ , such that

$$\begin{aligned} & \frac{1}{h} (v_n^i - v_n^{i-1}, \varphi) + (\nu + \nu_r)((\nabla_{x'} v_n^i, \nabla_{x'} \varphi)) + d(\mathbf{u}_n^i, v_n^i, \varphi) \\ & = q_n^i(1, \varphi) + 2\nu_r(\text{rot}_{x'} \mathbf{w}_n^i, \varphi) + (f_n^i, \varphi), \end{aligned} \quad (2.32)$$

for all  $\varphi \in W_0^{1,2}(\sigma)$ ,

$$\begin{aligned} & \frac{1}{h} ((\mathbf{w}_n^i - \mathbf{w}_n^{i-1}, \boldsymbol{\psi})) + (c_a + c_d)a(\mathbf{w}_n^i, \boldsymbol{\psi}) + b(\mathbf{u}_n^i, \mathbf{w}_n^i, \boldsymbol{\psi}) \\ & + (c_0 + c_d - c_a)(\text{div}_{x'} \mathbf{w}_n^i, \text{div}_{x'} \boldsymbol{\psi}) + 4\nu_r((\mathbf{w}_n^i, \boldsymbol{\psi})) = 2\nu_r((\nabla_{x'}^\perp v, \boldsymbol{\psi})) + ((\mathbf{g}_n^i, \boldsymbol{\psi})), \end{aligned} \quad (2.33)$$

for all  $\boldsymbol{\psi} \in W_0^{1,2}(\sigma)^2$ , and

$$\int_\sigma v_n^i dx' = F_n^i. \quad (2.34)$$

**Theorem 2.6** (Existence of the solution to (2.32)–(2.34)).

Let  $[v_n^{i-1}, \mathbf{w}_n^{i-1}] \in W_0^{1,2}(\sigma) \times W_0^{1,2}(\sigma)^2$  and  $\mathbf{u}_n^i \in V$  be given. Then there exists the triple  $[v_n^i, \mathbf{w}_n^i, q_n^i] \in W_0^{1,2}(\sigma) \times W_0^{1,2}(\sigma)^2 \times \mathbb{R}$ , the solution to the discrete problem (2.32)–(2.34).

*Proof.* Denote  $U = (v, \mathbf{w})$  and  $V = (\varphi, \boldsymbol{\psi})$  and define

$$\begin{aligned} \mathcal{B}(U, V) & = (\nu + \nu_r)((\nabla_{x'} v, \nabla_{x'} \varphi)) - 2\nu_r(\text{rot}_{x'} \mathbf{w}, \varphi) + (c_a + c_d)a(\mathbf{w}, \boldsymbol{\psi}) \\ & + (c_0 + c_d - c_a)(\text{div}_{x'} \mathbf{w}, \text{div}_{x'} \boldsymbol{\psi}) + 4\nu_r((\mathbf{w}, \boldsymbol{\psi})) - 2\nu_r((\nabla_{x'}^\perp v, \boldsymbol{\psi})). \end{aligned}$$

In [38] it is shown that

$$\mathcal{B}(U, V) \leq c \|U\|_{W^{1,2}(\sigma)^3} \|V\|_{W^{1,2}(\sigma)^3},$$

and

$$c \|U\|_{W^{1,2}(\sigma)^3}^2 \leq \mathcal{B}(U, U), \quad (2.35)$$

for all  $U, V \in W^{1,2}(\sigma)^3$ . Now, it is easy to show that the form  $\mathcal{A}$ , defined by the equation

$$\mathcal{A}(U, V) = \mathcal{B}(U, V) + \frac{1}{h}(v, \varphi) + d(\mathbf{u}_n^i, v, \varphi) + \frac{1}{h}((\mathbf{w}, \boldsymbol{\psi})) + b(\mathbf{u}_n^i, \mathbf{w}, \boldsymbol{\psi}), \quad (2.36)$$

is continuous. Moreover, applying the interpolation and Young's inequality we have

$$\begin{aligned} \left| \int_\sigma (\mathbf{u}_n^i \cdot \nabla_{x'} v) v dx' \right| & \leq c \|\mathbf{u}_n^i\|_{L^4(\sigma)^2} \|v\|_{W^{1,2}(\sigma)} \|v\|_{L^4(\sigma)} \\ & \leq C(\varepsilon) \|\mathbf{u}_n^i\|_{L^4(\sigma)^2}^4 \|v\|_{L^2(\sigma)}^2 + \varepsilon \|v\|_{W^{1,2}(\sigma)}^2, \end{aligned} \quad (2.37)$$

and

$$\begin{aligned} \left| \int_{\sigma} (\mathbf{u}_n^i \cdot \nabla_{x'} \mathbf{w}) \cdot \mathbf{w} \, dx' \right| &\leq c \|\mathbf{u}_n^i\|_{L^4(\sigma)^2} \|\mathbf{w}\|_{W^{1,2}(\sigma)^2} \|\mathbf{w}\|_{L^4(\sigma)^2} \\ &\leq C(\varepsilon) \|\mathbf{u}_n^i\|_{L^4(\sigma)^2}^4 \|\mathbf{w}\|_{L^2(\sigma)^2}^2 + \varepsilon \|\mathbf{w}\|_{W^{1,2}(\sigma)^2}^2. \end{aligned} \quad (2.38)$$

Taking  $V = U$  in (2.36), using (2.30), (2.35), (2.37) and (2.38) and taking  $h$  and  $\varepsilon$  “small enough” we can write

$$\begin{aligned} \mathcal{A}(U, U) &\geq \mathcal{B}(U, U) + \frac{1}{h} \|v\|_{L^2(\sigma)}^2 + \frac{1}{h} \|\mathbf{w}\|_{L^2(\sigma)^2}^2 \\ &\quad - \left| \int_{\sigma} (\mathbf{u}_n^i \cdot \nabla_{x'}) v \, v \, dx' \right| - \left| \int_{\sigma} (\mathbf{u}_n^i \cdot \nabla_{x'}) \mathbf{w} \cdot \mathbf{w} \, dx' \right| \\ &\geq \mathcal{B}(U, U) + \frac{1}{h} \|v\|_{L^2(\sigma)}^2 + \frac{1}{h} \|\mathbf{w}\|_{L^2(\sigma)^2}^2 \\ &\quad - C(\varepsilon) \|\mathbf{u}_n^i\|_{L^4(\sigma)^2}^4 \|v\|_{L^2(\sigma)}^2 - \varepsilon \|v\|_{W^{1,2}(\sigma)}^2 \\ &\quad - C(\varepsilon) \|\mathbf{u}_n^i\|_{L^4(\sigma)^2}^4 \|\mathbf{w}\|_{L^2(\sigma)^2}^2 - \varepsilon \|\mathbf{w}\|_{W^{1,2}(\sigma)^2}^2 \\ &\geq c \|U\|_{W^{1,2}(\sigma)^3}^2. \end{aligned} \quad (2.39)$$

Hence, there exists  $h_0 > 0$  (“small enough”) such that for all  $h \leq h_0$ , the form  $\mathcal{A}$ , defined by the equation (2.36) is continuous and coercive. By the Lax-Milgram theorem, there exists  $(v_R, \mathbf{w}_R)$  such that

$$\frac{1}{h} (v_R, \varphi) + (\nu + \nu_r) ((\nabla_{x'} v_R, \nabla_{x'} \varphi)) + d(\mathbf{u}_n^i, v_R, \varphi) - 2\nu_r (\text{rot}_{x'} \mathbf{w}_R, \varphi) = \frac{1}{h} (v_n^{i-1}, \varphi) + (f_n^i, \varphi),$$

for all  $\varphi \in W_0^{1,2}(\sigma)$ , and

$$\begin{aligned} &\frac{1}{h} ((\mathbf{w}_R, \boldsymbol{\psi})) + (c_a + c_d) a(\mathbf{w}_R, \boldsymbol{\psi}) + (c_0 + c_d - c_a) (\text{div}_{x'} \mathbf{w}_R, \text{div}_{x'} \boldsymbol{\psi}) \\ &+ b(\mathbf{u}_n^i, \mathbf{w}_R, \boldsymbol{\psi}) + 4\nu_r ((\mathbf{w}_R, \boldsymbol{\psi})) - 2\nu_r ((\nabla_{x'}^\perp v_R, \boldsymbol{\psi})) = \frac{1}{h} ((\mathbf{w}_n^{i-1}, \boldsymbol{\psi})) + ((\mathbf{g}_n^i, \boldsymbol{\psi})), \end{aligned}$$

for all  $\boldsymbol{\psi} \in W_0^{1,2}(\sigma)^2$ . Similarly, there exists  $(\tilde{v}_F, \tilde{\mathbf{w}}_F)$  such that

$$\begin{aligned} &\frac{1}{h} (\tilde{v}_F, \varphi) + (\nu + \nu_r) ((\nabla_{x'} \tilde{v}_F, \nabla_{x'} \varphi)) + d(\mathbf{u}_n^i, \tilde{v}_F, \varphi) \\ &- 2\nu_r (\text{rot}_{x'} \tilde{\mathbf{w}}_F, \varphi) = (1, \varphi), \end{aligned} \quad (2.40)$$

for all  $\varphi \in W_0^{1,2}(\sigma)$ , and

$$\begin{aligned} &\frac{1}{h} ((\tilde{\mathbf{w}}_F, \boldsymbol{\psi})) + (c_a + c_d) a(\tilde{\mathbf{w}}_F, \boldsymbol{\psi}) + (c_0 + c_d - c_a) (\text{div}_{x'} \tilde{\mathbf{w}}_F, \text{div}_{x'} \boldsymbol{\psi}) \\ &+ b(\mathbf{u}_n^i, \tilde{\mathbf{w}}_F, \boldsymbol{\psi}) + 4\nu_r ((\tilde{\mathbf{w}}_F, \boldsymbol{\psi})) - 2\nu_r ((\nabla_{x'}^\perp \tilde{v}_F, \boldsymbol{\psi})) = 0, \end{aligned} \quad (2.41)$$

for all  $\boldsymbol{\psi} \in W_0^{1,2}(\sigma)^2$ . Using  $\varphi = \tilde{v}_F$  and  $\boldsymbol{\psi} = \tilde{\mathbf{w}}_F$  in (2.40) and (2.41), respectively, we

verify (in view of coercivity of  $\mathcal{A}$ ) that

$$\int_{\sigma} \tilde{v}_F dx' \neq 0.$$

Now, let

$$\tilde{C}_F := \int_{\sigma} \tilde{v}_F dx' \quad \text{and} \quad C_R := \int_{\sigma} v_R dx'.$$

Furthermore, by the same arguments (Lax-Milgram) we have  $[v_F, \mathbf{w}_F]$ , the solution to the problem

$$\begin{aligned} & \frac{1}{h}(v_F, \varphi) + (\nu + \nu_r)((\nabla_{x'} v_F, \nabla_{x'} \varphi)) \\ & + d(\mathbf{u}_n^i, v_F, \varphi) - 2\nu_r(\text{rot}_{x'} \mathbf{w}_F, \varphi) = \frac{F_n^i - C_R}{\tilde{C}_F}(1, \varphi), \end{aligned} \quad (2.42)$$

for all  $\varphi \in W_0^{1,2}(\sigma)$ , and

$$\begin{aligned} & \frac{1}{h}((\mathbf{w}_F, \boldsymbol{\psi})) + (c_a + c_d)a(\mathbf{w}_F, \boldsymbol{\psi}) + (c_0 + c_d - c_a)(\text{div} \mathbf{w}_F, \text{div} \boldsymbol{\psi}) \\ & + b(\mathbf{u}_n^i, \mathbf{w}_F, \boldsymbol{\psi}) + 4\nu_r((\mathbf{w}_F, \boldsymbol{\psi})) - 2\nu_r((\nabla^\perp v_F, \boldsymbol{\psi})) = 0, \end{aligned} \quad (2.43)$$

for all  $\boldsymbol{\psi} \in W_0^{1,2}(\sigma)^2$ . Now, comparing (2.40)–(2.41) and (2.42)–(2.43) we can write

$$v_F = \tilde{v}_F \frac{F_n^i - C_R}{\tilde{C}_F} \quad \text{and} \quad \mathbf{w}_F = \tilde{\mathbf{w}}_F \frac{F_n^i - C_R}{\tilde{C}_F}.$$

Finally, let us set

$$v_n^i = v_F + v_R, \quad \mathbf{w}_n^i = \mathbf{w}_F + \mathbf{w}_R \quad \text{and} \quad q_n^i = \frac{F_n^i - C_R}{\tilde{C}_F}.$$

It is easy to see that  $v_n^i$ ,  $q_n^i$  and  $\mathbf{w}_n^i$  solve (2.32) and (2.33) and  $v_n^i$  has the correct net flux which can be verified as

$$\int_{\sigma} v_n^i dx' = \int_{\sigma} v_F + v_R dx' = \frac{F_n^i - C_R}{\tilde{C}_F} \int_{\sigma} \tilde{v}_F dx' + C_R = \frac{F_n^i - C_R}{\tilde{C}_F} \tilde{C}_F + C_R = F_n^i.$$

□

### 2.3.2 Apriori Estimates

Using  $\varphi = (v_n^i - v_n^{i-1})/h$  as a test function in (2.32) we obtain

$$\begin{aligned} & \left\| \frac{v_n^i - v_n^{i-1}}{h} \right\|_{L^2(\sigma)}^2 + \frac{(\nu + \nu_r)}{2h} \left\| \nabla_{x'} v_n^i \right\|_{L^2(\sigma)^2}^2 - \frac{(\nu + \nu_r)}{2h} \left\| \nabla_{x'} v_n^{i-1} \right\|_{L^2(\sigma)^2}^2 \\ & + \frac{(\nu + \nu_r)}{2h} \left\| \nabla_{x'} v_n^i - \nabla_{x'} v_n^{i-1} \right\|_{L^2(\sigma)^2}^2 \leq \frac{2\nu_r}{h} (\text{rot}_{x'} \mathbf{w}_n^i, v_n^i - v_n^{i-1}) - \frac{1}{h} d(\mathbf{u}_n^i, v_n^i, v_n^i - v_n^{i-1}) \\ & + \varepsilon |q_n^i|^2 + \frac{c}{\varepsilon} \left| \frac{F_n^i - F_n^{i-1}}{h} \right|^2 + \varepsilon \left\| \frac{v_n^i - v_n^{i-1}}{h} \right\|_{L^2(\sigma)}^2 + \frac{c}{\varepsilon} \|f_n^i\|_{L^2(\sigma)}^2. \end{aligned} \quad (2.44)$$

For the second term on the right-hand side in (2.44) we can write using (2.30)–(2.31):

$$\begin{aligned} \frac{1}{h} |d(\mathbf{u}_n^i, v_n^i, v_n^i - v_n^{i-1})| & \leq \frac{1}{h} \|\mathbf{u}_n^i\|_{L^4(\sigma)^2} \|v_n^i - v_n^{i-1}\|_{W^{1,2}(\sigma)} \|v_n^i - v_n^{i-1}\|_{L^4(\sigma)} \\ & + \|\mathbf{u}_n^i\|_{L^\infty(\sigma)^2} \|v_n^{i-1}\|_{W^{1,2}(\sigma)} \left\| \frac{v_n^i - v_n^{i-1}}{h} \right\|_{L^2(\sigma)}. \end{aligned} \quad (2.45)$$

For the first term on the right-hand side in (2.45), we have

$$\begin{aligned} & \frac{1}{h} \|\mathbf{u}_n^i\|_{L^4(\sigma)^2} \|v_n^i - v_n^{i-1}\|_{W^{1,2}(\sigma)} \|v_n^i - v_n^{i-1}\|_{L^4(\sigma)} \\ & \leq \frac{c}{h} \|\mathbf{u}_n^i\|_{L^4(\sigma)^2} \|v_n^i - v_n^{i-1}\|_{W^{1,2}(\sigma)}^{3/2} \|v_n^i - v_n^{i-1}\|_{L^2(\sigma)}^{1/2} \\ & \leq \frac{\varepsilon}{h} \|v_n^i - v_n^{i-1}\|_{W^{1,2}(\sigma)}^2 + \frac{C(\varepsilon)}{h} \|\mathbf{u}_n^i\|_{L^4(\sigma)^2}^4 \|v_n^i - v_n^{i-1}\|_{L^2(\sigma)}^2. \end{aligned}$$

For the second term on the right-hand side in (2.45), we have

$$\begin{aligned} \|\mathbf{u}_n^i\|_{L^\infty(\sigma)^2} \|v_n^{i-1}\|_{W^{1,2}(\sigma)} \left\| \frac{v_n^i - v_n^{i-1}}{h} \right\|_{L^2(\sigma)} & \leq \varepsilon \left\| \frac{v_n^i - v_n^{i-1}}{h} \right\|_{L^2(\sigma)}^2 \\ & + C(\varepsilon) \|\mathbf{u}_n^i\|_{L^\infty(\sigma)^2}^2 \|v_n^{i-1}\|_{W^{1,2}(\sigma)}^2. \end{aligned} \quad (2.46)$$

Now, combining (2.45), (2.46), (2.46) together with (2.44), we get

$$\begin{aligned} & (1 - 2\varepsilon) \left\| \frac{v_n^i - v_n^{i-1}}{h} \right\|_{L^2(\sigma)}^2 + \frac{(\nu + \nu_r)}{2h} \left\| \nabla_{x'} v_n^i \right\|_{L^2(\sigma)^2}^2 - \frac{(\nu + \nu_r)}{2h} \left\| \nabla_{x'} v_n^{i-1} \right\|_{L^2(\sigma)^2}^2 \\ & + \frac{(\nu + \nu_r)}{2h} \left\| \nabla_{x'} v_n^i - \nabla_{x'} v_n^{i-1} \right\|_{L^2(\sigma)^2}^2 \leq \frac{2\nu_r}{h} (\text{rot}_{x'} \mathbf{w}_n^i, v_n^i - v_n^{i-1}) + \frac{\varepsilon}{h} \|v_n^i - v_n^{i-1}\|_{W^{1,2}(\sigma)}^2 \\ & + \frac{C(\varepsilon)}{h} \|\mathbf{u}_n^i\|_{L^4(\sigma)^2}^4 \|v_n^i - v_n^{i-1}\|_{L^2(\sigma)}^2 + \varepsilon |q_n^i|^2 + \frac{c}{\varepsilon} \left| \frac{F_n^i - F_n^{i-1}}{h} \right|^2 \\ & + \frac{c}{\varepsilon} \|f_n^i\|_{L^2(\sigma)}^2 + C(\varepsilon) \|\mathbf{u}_n^i\|_{L^\infty(\sigma)^2}^2 \|v_n^{i-1}\|_{W^{1,2}(\sigma)}^2. \end{aligned} \quad (2.47)$$

Likewise, using  $\boldsymbol{\psi} = (\mathbf{w}_n^i - \mathbf{w}_n^{i-1})/h$  in (2.33), we arrive at

$$\begin{aligned}
 & \left\| \frac{\mathbf{w}_n^i - \mathbf{w}_n^{i-1}}{h} \right\|_{L^2(\sigma)^2}^2 + \frac{(c_a + c_d)}{2h} a(\mathbf{w}_n^i, \mathbf{w}_n^i) - \frac{(c_a + c_d)}{2h} a(\mathbf{w}_n^{i-1}, \mathbf{w}_n^{i-1}) \\
 & + \frac{(c_a + c_d)}{2h} a(\mathbf{w}_n^i - \mathbf{w}_n^{i-1}, \mathbf{w}_n^i - \mathbf{w}_n^{i-1}) + \frac{(c_0 + c_d - c_a)}{2h} \left\| \operatorname{div}_{x'} \mathbf{w}_n^i \right\|_{L^2(\sigma)}^2 \\
 & - \frac{(c_0 + c_d - c_a)}{2h} \left\| \operatorname{div}_{x'} \mathbf{w}_n^{i-1} \right\|_{L^2(\sigma)}^2 + \frac{(c_0 + c_d - c_a)}{2h} \left\| \operatorname{div}_{x'} \mathbf{w}_n^i - \operatorname{div}_{x'} \mathbf{w}_n^{i-1} \right\|_{L^2(\sigma)}^2 \\
 & + \frac{4\nu_r}{2h} \left\| \mathbf{w}_n^i \right\|_{L^2(\sigma)^2}^2 - \frac{4\nu_r}{2h} \left\| \mathbf{w}_n^{i-1} \right\|_{L^2(\sigma)^2}^2 + \frac{4\nu_r}{2h} \left\| \mathbf{w}_n^i - \mathbf{w}_n^{i-1} \right\|_{L^2(\sigma)^2}^2 \\
 & \leq \frac{2\nu_r}{h} ((\nabla_{x'}^\perp v_n^i, \mathbf{w}_n^i - \mathbf{w}_n^{i-1})) + \varepsilon \left\| \frac{\mathbf{w}_n^i - \mathbf{w}_n^{i-1}}{h} \right\|_{L^2(\sigma)^2}^2 \\
 & + \frac{c}{\varepsilon} \left\| \mathbf{g}_n^i \right\|_{L^2(\sigma)^2}^2 - \frac{1}{h} b(\mathbf{u}_n^i, \mathbf{w}_n^i, \mathbf{w}_n^i - \mathbf{w}_n^{i-1}).
 \end{aligned} \tag{2.48}$$

Adding first terms on the right hand sides in (2.44) and (2.48), we deduce

$$\begin{aligned}
 & \frac{2\nu_r}{h} (\operatorname{rot}_{x'} \mathbf{w}_n^i, v_n^i - v_n^{i-1}) + \frac{2\nu_r}{h} ((\nabla_{x'}^\perp v_n^i, \mathbf{w}_n^i - \mathbf{w}_n^{i-1})) \\
 & = \frac{2\nu_r}{h} ((\mathbf{w}_n^i, \nabla_{x'}^\perp v_n^i)) - \frac{2\nu_r}{h} ((\mathbf{w}_n^{i-1}, \nabla_{x'}^\perp v_n^{i-1})) + \frac{2\nu_r}{h} ((\mathbf{w}_n^i - \mathbf{w}_n^{i-1}, \nabla_{x'}^\perp (v_n^i - v_n^{i-1}))).
 \end{aligned} \tag{2.49}$$

By Young's inequality we have

$$\frac{2\nu_r}{h} ((\mathbf{w}_n^i - \mathbf{w}_n^{i-1}, \nabla_{x'}^\perp (v_n^i - v_n^{i-1}))) \leq \frac{2\nu_r}{h} \frac{1}{4} \left\| \nabla_{x'} (v_n^i - v_n^{i-1}) \right\|_{L^2(\sigma)^2}^2 + \frac{2\nu_r}{h} \left\| \mathbf{w}_n^i - \mathbf{w}_n^{i-1} \right\|_{L^2(\sigma)^2}^2. \tag{2.50}$$

For the last term on the right-hand side in (2.48) we can write

$$\begin{aligned}
 \frac{1}{h} |b(\mathbf{u}_n^i, \mathbf{w}_n^i, \mathbf{w}_n^i - \mathbf{w}_n^{i-1})| & \leq \frac{1}{h} \left\| \mathbf{u}_n^i \right\|_{L^4(\sigma)^2} \left\| \mathbf{w}_n^i - \mathbf{w}_n^{i-1} \right\|_{W^{1,2}(\sigma)^2} \left\| \mathbf{w}_n^i - \mathbf{w}_n^{i-1} \right\|_{L^4(\sigma)^2} \\
 & + \left\| \mathbf{u}_n^i \right\|_{L^\infty(\sigma)^2} \left\| \mathbf{w}_n^{i-1} \right\|_{W^{1,2}(\sigma)^2} \left\| \frac{\mathbf{w}_n^i - \mathbf{w}_n^{i-1}}{h} \right\|_{L^2(\sigma)^2}.
 \end{aligned} \tag{2.51}$$

For the first term on the right-hand side in (2.51) we have

$$\begin{aligned}
 & \frac{1}{h} \left\| \mathbf{u}_n^i \right\|_{L^4(\sigma)^2} \left\| \mathbf{w}_n^i - \mathbf{w}_n^{i-1} \right\|_{W^{1,2}(\sigma)^2} \left\| \mathbf{w}_n^i - \mathbf{w}_n^{i-1} \right\|_{L^4(\sigma)^2} \\
 & \leq \frac{c}{h} \left\| \mathbf{u}_n^i \right\|_{L^4(\sigma)^2} \left\| \mathbf{w}_n^i - \mathbf{w}_n^{i-1} \right\|_{W^{1,2}(\sigma)^2}^{3/2} \left\| \mathbf{w}_n^i - \mathbf{w}_n^{i-1} \right\|_{L^2(\sigma)^2}^{1/2} \\
 & \leq \frac{\varepsilon}{h} \left\| \mathbf{w}_n^i - \mathbf{w}_n^{i-1} \right\|_{W^{1,2}(\sigma)^2}^2 + \frac{C(\varepsilon)}{h} \left\| \mathbf{u}_n^i \right\|_{L^4(\sigma)^2}^4 \left\| \mathbf{w}_n^i - \mathbf{w}_n^{i-1} \right\|_{L^2(\sigma)^2}^2.
 \end{aligned} \tag{2.52}$$

For the second term on the right-hand side in (2.51) we have

$$\begin{aligned} \|\mathbf{u}_n^i\|_{L^\infty(\sigma)^2} \|\mathbf{w}_n^{i-1}\|_{W^{1,2}(\sigma)^2} \left\| \frac{\mathbf{w}_n^i - \mathbf{w}_n^{i-1}}{h} \right\|_{L^2(\sigma)^2} &\leq \varepsilon \left\| \frac{\mathbf{w}_n^i - \mathbf{w}_n^{i-1}}{h} \right\|_{L^2(\sigma)^2}^2 \\ &+ C(\varepsilon) \|\mathbf{u}_n^i\|_{L^\infty(\sigma)^2}^2 \|\mathbf{w}_n^{i-1}\|_{W^{1,2}(\sigma)^2}^2. \end{aligned} \quad (2.53)$$

Now, summing (2.47) together with (2.48) and using (2.49)–(2.53) we arrive at

$$\begin{aligned} &(1 - 2\varepsilon) \left\| \frac{v_n^i - v_n^{i-1}}{h} \right\|_{L^2(\sigma)}^2 + (1 - 2\varepsilon) \left\| \frac{\mathbf{w}_n^i - \mathbf{w}_n^{i-1}}{h} \right\|_{L^2(\sigma)^2}^2 + \frac{(\nu + \nu_r)}{2h} \|\nabla_{x'} v_n^i\|_{L^2(\sigma)^2}^2 \\ &- \frac{(\nu + \nu_r)}{2h} \|\nabla_{x'} v_n^{i-1}\|_{L^2(\sigma)^2}^2 + \frac{(c_a + c_d)}{2h} a(\mathbf{w}_n^i, \mathbf{w}_n^i) - \frac{(c_a + c_d)}{2h} a(\mathbf{w}_n^{i-1}, \mathbf{w}_n^{i-1}) \\ &+ \frac{\nu}{2h} \|\nabla_{x'} v_n^i - \nabla_{x'} v_n^{i-1}\|_{L^2(\sigma)^2}^2 + \frac{(c_a + c_d)}{2h} a(\mathbf{w}_n^i - \mathbf{w}_n^{i-1}, \mathbf{w}_n^i - \mathbf{w}_n^{i-1}) \\ &+ \frac{(c_0 + c_d - c_a)}{2h} \|\operatorname{div}_{x'} \mathbf{w}_n^i\|_{L^2(\sigma)}^2 - \frac{(c_0 + c_d - c_a)}{2h} \|\operatorname{div}_{x'} \mathbf{w}_n^{i-1}\|_{L^2(\sigma)}^2 \\ &+ \frac{(c_0 + c_d - c_a)}{2h} \|\operatorname{div}_{x'} \mathbf{w}_n^i - \operatorname{div}_{x'} \mathbf{w}_n^{i-1}\|_{L^2(\sigma)}^2 + \frac{4\nu_r}{2h} \|\mathbf{w}_n^i\|_{L^2(\sigma)^2}^2 - \frac{4\nu_r}{2h} \|\mathbf{w}_n^{i-1}\|_{L^2(\sigma)^2}^2 \\ &\leq \frac{\varepsilon}{h} \|v_n^i - v_n^{i-1}\|_{W^{1,2}(\sigma)}^2 + \frac{C(\varepsilon)}{h} \|\mathbf{u}_n^i\|_{L^4(\sigma)^2}^4 \|v_n^i - v_n^{i-1}\|_{L^2(\sigma)}^2 + \frac{\varepsilon}{h} \|\mathbf{w}_n^i - \mathbf{w}_n^{i-1}\|_{W^{1,2}(\sigma)^2}^2 \\ &+ \frac{C(\varepsilon)}{h} \|\mathbf{u}_n^i\|_{L^4(\sigma)^2}^4 \|\mathbf{w}_n^i - \mathbf{w}_n^{i-1}\|_{L^2(\sigma)^2}^2 + \varepsilon |q_n^i|^2 + \frac{c}{\varepsilon} \left| \frac{F_n^i - F_n^{i-1}}{h} \right|^2 + \frac{c}{\varepsilon} \|f_n^i\|_{L^2(\sigma)}^2 \\ &+ C(\varepsilon) \|\mathbf{u}_n^i\|_{L^\infty(\sigma)^2}^2 \|v_n^{i-1}\|_{W^{1,2}(\sigma)}^2 + C(\varepsilon) \|\mathbf{u}_n^i\|_{L^\infty(\sigma)^2}^2 \|\mathbf{w}_n^{i-1}\|_{W^{1,2}(\sigma)^2}^2 \\ &+ \frac{c}{\varepsilon} \|\mathbf{g}_n^i\|_{L^2(\sigma)^2}^2 + \frac{2\nu_r}{h} ((\mathbf{w}_n^i, \nabla_{x'}^\perp v_n^i)) - \frac{2\nu_r}{h} ((\mathbf{w}_n^{i-1}, \nabla_{x'}^\perp v_n^{i-1})). \end{aligned} \quad (2.54)$$

Summing (2.54) for  $i = 1, 2, \dots, k$  we get

$$\begin{aligned} &(1 - 2\varepsilon) \sum_{i=1}^k \left\| \frac{v_n^i - v_n^{i-1}}{h} \right\|_{L^2(\sigma)}^2 + (1 - 2\varepsilon) \sum_{i=1}^k \left\| \frac{\mathbf{w}_n^i - \mathbf{w}_n^{i-1}}{h} \right\|_{L^2(\sigma)^2}^2 + \frac{(\nu + \nu_r)}{2h} \|\nabla_{x'} v_n^k\|_{L^2(\sigma)^2}^2 \\ &+ \frac{\nu}{2h} \sum_{i=1}^k \|\nabla_{x'} v_n^i - \nabla_{x'} v_n^{i-1}\|_{L^2(\sigma)^2}^2 + \frac{(c_a + c_d)}{2h} a(\mathbf{w}_n^k, \mathbf{w}_n^k) \\ &+ \frac{(c_a + c_d)}{2h} \sum_{i=1}^k a(\mathbf{w}_n^i - \mathbf{w}_n^{i-1}, \mathbf{w}_n^i - \mathbf{w}_n^{i-1}) + \frac{4\nu_r}{2h} \|\mathbf{w}_n^k\|_{L^2(\sigma)^2}^2 \\ &+ \frac{(c_0 + c_d - c_a)}{2h} \|\operatorname{div}_{x'} \mathbf{w}_n^k\|_{L^2(\sigma)}^2 + \frac{(c_0 + c_d - c_a)}{2h} \sum_{i=1}^k \|\operatorname{div}_{x'} \mathbf{w}_n^i - \operatorname{div}_{x'} \mathbf{w}_n^{i-1}\|_{L^2(\sigma)}^2 \\ &\leq \frac{\varepsilon}{h} \sum_{i=1}^k \|v_n^i - v_n^{i-1}\|_{W^{1,2}(\sigma)}^2 + \frac{C(\varepsilon)}{h} \sum_{i=1}^k \|\mathbf{u}_n^i\|_{L^4(\sigma)^2}^4 \|v_n^i - v_n^{i-1}\|_{L^2(\sigma)}^2 \\ &+ \frac{\varepsilon}{h} \sum_{i=1}^k \|\mathbf{w}_n^i - \mathbf{w}_n^{i-1}\|_{W^{1,2}(\sigma)^2}^2 + \frac{C(\varepsilon)}{h} \sum_{i=1}^k \|\mathbf{u}_n^i\|_{L^4(\sigma)^2}^4 \|\mathbf{w}_n^i - \mathbf{w}_n^{i-1}\|_{L^2(\sigma)^2}^2 \\ &+ \varepsilon \sum_{i=1}^k |q_n^i|^2 + \frac{c}{\varepsilon} \sum_{i=1}^k \left| \frac{F_n^i - F_n^{i-1}}{h} \right|^2 + \frac{c}{\varepsilon} \sum_{i=1}^k \|f_n^i\|_{L^2(\sigma)}^2 \end{aligned}$$

$$\begin{aligned}
 & + C(\varepsilon) \sum_{i=1}^k \|\mathbf{u}_n^i\|_{L^\infty(\sigma)^2}^2 \|v_n^{i-1}\|_{W^{1,2}(\sigma)}^2 + C(\varepsilon) \sum_{i=1}^k \|\mathbf{u}_n^i\|_{L^\infty(\sigma)^2}^2 \|\mathbf{w}_n^{i-1}\|_{W^{1,2}(\sigma)}^2 \\
 & + \frac{c}{\varepsilon} \sum_{i=1}^k \|\mathbf{g}_n^i\|_{L^2(\sigma)^2}^2 + \frac{2\nu_r}{h} ((\mathbf{w}_n^k, \nabla_{x'}^\perp v_n^k)) - \frac{2\nu_r}{h} ((\mathbf{w}_n^0, \nabla_{x'}^\perp v_n^0)) + \frac{2\nu_r}{h} \|\mathbf{w}_n^0\|_{L^2(\sigma)^2}^2 \\
 & + \frac{(\nu + \nu_r)}{2h} \|\nabla_{x'} v_n^0\|_{L^2(\sigma)^2}^2 + \frac{(c_a + c_d)}{2h} a(\mathbf{w}_n^0, \mathbf{w}_n^0) + \frac{(c_0 + c_d - c_a)}{2h} \|\operatorname{div}_{x'} \mathbf{w}_n^0\|_{L^2(\sigma)}^2.
 \end{aligned} \tag{2.55}$$

Again, applying Young's inequality we can write

$$\frac{2\nu_r}{h} ((\mathbf{w}_n^k, \nabla_{x'}^\perp v_n^k)) \leq \frac{2\nu_r}{h} \frac{1}{4} \|\nabla_{x'} v_n^k\|_{L^2(\sigma)^2}^2 + \frac{2\nu_r}{h} \|\mathbf{w}_n^k\|_{L^2(\sigma)^2}^2. \tag{2.56}$$

By the Friedrichs inequality we have

$$\frac{\varepsilon}{h} \sum_{i=1}^k \|v_n^i - v_n^{i-1}\|_{W^{1,2}(\sigma)}^2 \leq C \frac{\varepsilon}{h} \sum_{i=1}^k \|\nabla_{x'} v_n^i - \nabla_{x'} v_n^{i-1}\|_{L^2(\sigma)^2}^2, \tag{2.57}$$

and

$$\frac{\varepsilon}{h} \sum_{i=1}^k \|\mathbf{w}_n^i - \mathbf{w}_n^{i-1}\|_{W^{1,2}(\sigma)^2}^2 \leq C \frac{\varepsilon}{h} \sum_{i=1}^k a(\mathbf{w}_n^i - \mathbf{w}_n^{i-1}, \mathbf{w}_n^i - \mathbf{w}_n^{i-1}). \tag{2.58}$$

Finally, in view of (2.30), we have

$$\frac{C(\varepsilon)}{h} \sum_{i=1}^k \|\mathbf{u}_n^i\|_{L^4(\sigma)^2}^4 \|v_n^i - v_n^{i-1}\|_{L^2(\sigma)}^2 \leq hcC(\varepsilon) \sum_{i=1}^k \left\| \frac{v_n^i - v_n^{i-1}}{h} \right\|_{L^2(\sigma)}^2, \tag{2.59}$$

and

$$\frac{C(\varepsilon)}{h} \sum_{i=1}^k \|\mathbf{u}_n^i\|_{L^4(\sigma)^2}^4 \|\mathbf{w}_n^i - \mathbf{w}_n^{i-1}\|_{L^2(\sigma)^2}^2 \leq hcC(\varepsilon) \sum_{i=1}^k \left\| \frac{\mathbf{w}_n^i - \mathbf{w}_n^{i-1}}{h} \right\|_{L^2(\sigma)^2}^2. \tag{2.60}$$

Hence, using (2.56)–(2.60), the inequality (2.55) can be further simplified as

$$\begin{aligned}
 & (1 - 2\varepsilon - hcC(\varepsilon)) \sum_{i=1}^k \left\| \frac{v_n^i - v_n^{i-1}}{h} \right\|_{L^2(\sigma)}^2 + \frac{\nu}{2h} \|\nabla_{x'} v_n^k\|_{L^2(\sigma)^2}^2 \\
 & + \frac{1}{h} \left( \frac{\nu}{2} - C\varepsilon \right) \sum_{i=1}^k \|\nabla_{x'} v_n^i - \nabla_{x'} v_n^{i-1}\|_{L^2(\sigma)^2}^2 + (1 - 2\varepsilon - hcC(\varepsilon)) \sum_{i=1}^k \left\| \frac{\mathbf{w}_n^i - \mathbf{w}_n^{i-1}}{h} \right\|_{L^2(\sigma)^2}^2 \\
 & + \frac{(c_a + c_d)}{2h} a(\mathbf{w}_n^k, \mathbf{w}_n^k) + \frac{1}{h} \left( \frac{c_a + c_d}{2} - C\varepsilon \right) \sum_{i=1}^k a(\mathbf{w}_n^i - \mathbf{w}_n^{i-1}, \mathbf{w}_n^i - \mathbf{w}_n^{i-1}) \\
 & \leq \varepsilon \sum_{i=1}^k |q_n^i|^2 + C(\varepsilon) \sum_{i=1}^k \|\mathbf{u}_n^i\|_{L^\infty(\sigma)^2}^2 \left( \|v_n^{i-1}\|_{W^{1,2}(\sigma)}^2 + \|\mathbf{w}_n^{i-1}\|_{W^{1,2}(\sigma)}^2 \right) \\
 & \quad + \frac{c}{\varepsilon} \sum_{i=1}^k \left| \frac{F_n^i - F_n^{i-1}}{h} \right|^2 + \frac{c}{\varepsilon} \sum_{i=1}^k \|f_n^i\|_{L^2(\sigma)}^2 + \frac{c}{\varepsilon} \sum_{i=1}^k \|\mathbf{g}_n^i\|_{L^2(\sigma)^2}^2
 \end{aligned}$$

$$\begin{aligned}
 & -\frac{2\nu_r}{h}(\mathbf{w}_n^0, \nabla_{x'}^\perp v_n^0) + \frac{2\nu_r}{h} \|\mathbf{w}_n^0\|_{L^2(\sigma)^2}^2 + \frac{(\nu + \nu_r)}{2h} \|\nabla_{x'} v_n^0\|_{L^2(\sigma)^2}^2 \\
 & + \frac{(c_a + c_d)}{2h} a(\mathbf{w}_n^0, \mathbf{w}_n^0) + \frac{(c_0 + c_d - c_a)}{2h} \|\operatorname{div}_{x'} \mathbf{w}_n^0\|_{L^2(\sigma)}^2.
 \end{aligned} \tag{2.61}$$

What remains is to handle the first term on the right hand side in (2.61). Here we follow the ideas used in [33]. Let  $V^0$  be the solution of the following Dirichlet problem for the Poisson equation:

$$-(\nu + \nu_r)\Delta_{x'} V^0 = 1 \quad \text{in } \sigma, \tag{2.62}$$

$$V^0 = 0 \quad \text{on } \partial\sigma. \tag{2.63}$$

Using  $\varphi = V^0$  as a test function in (2.32) we obtain

$$\begin{aligned}
 & \frac{1}{h}(v_n^i - v_n^{i-1}, V^0) + (\nu + \nu_r)((\nabla_{x'} v_n^i, \nabla_{x'} V^0)) + d(\mathbf{u}_n^i, v_n^i, V^0) \\
 & = q_n^i(1, V^0) + 2\nu_r(\operatorname{rot}_{x'} \mathbf{w}_n^i, V^0) + (f_n^i, V^0).
 \end{aligned} \tag{2.64}$$

From (2.62)–(2.63) and (2.34) we have

$$(\nu + \nu_r)((\nabla_{x'} v_n^i, \nabla_{x'} V^0)) = \int_\sigma v_n^i dx' = F_n^i. \tag{2.65}$$

Hence, combining (2.64) with (2.65), we get

$$\begin{aligned}
 & \frac{1}{h}(v_n^i - v_n^{i-1}, V^0) + F_n^i + d(\mathbf{u}_n^i, v_n^i, V^0) \\
 & = q_n^i \int_\sigma V^0 dx' + 2\nu_r(\operatorname{rot}_{x'} \mathbf{w}_n^i, V^0) + (f_n^i, V^0).
 \end{aligned} \tag{2.66}$$

Furthermore, we have

$$d(\mathbf{u}_n^i, v_n^i, V^0) \leq c \|\mathbf{u}_n^i\|_{L^4(\sigma)^2} \|v_n^i\|_{W^{1,2}(\sigma)} \|V^0\|_{L^4(\sigma)}.$$

From (2.66) we have

$$\begin{aligned}
 |q_n^i|^2 \left| \int_\sigma V^0 dx' \right|^2 & \leq c \left\| \frac{v_n^i - v_n^{i-1}}{h} \right\|_{L^2(\sigma)}^2 \|V^0\|_{L^2(\sigma)}^2 + c(F_n^i)^2 + c\|\mathbf{u}_n^i\|_{L^4(\sigma)^2}^2 \|v_n^i\|_{W^{1,2}(\sigma)}^2 \|V^0\|_{L^4(\sigma)}^2 \\
 & + c(2\nu_r)^2 \|\operatorname{rot}_{x'} \mathbf{w}_n^i\|_{L^2(\sigma)}^2 \|V^0\|_{L^2(\sigma)}^2 + c\|f_n^i\|_{L^2(\sigma)}^2 \|V^0\|_{L^2(\sigma)}^2.
 \end{aligned} \tag{2.67}$$

Using Friedrichs' inequality

$$\int_\sigma |V^0|^2 dx' \leq C \int_\sigma |\nabla_{x'} V^0|^2 dx',$$



and (2.62)–(2.63), we deduce

$$\int_{\sigma} |V^0|^2 dx' \leq C \int_{\sigma} |\nabla_{x'} V^0|^2 dx' = \frac{C}{(\nu + \nu_r)} \int_{\sigma} V^0 dx' = \frac{C\kappa_0}{(\nu + \nu_r)}, \quad (2.68)$$

where  $\kappa_0 = \int_{\sigma} V^0 dx'$ . Moreover, by the Sobolev embedding theorem (see [17]), we can write

$$\|V^0\|_{L^4(\sigma)}^2 \leq c_1 \|V^0\|_{W^{1,2}(\sigma)}^2 \leq C \int_{\sigma} |\nabla_{x'} V^0|^2 dx' = \frac{C\kappa_0}{(\nu + \nu_r)}. \quad (2.69)$$

Now, combining (2.67) with (2.68)–(2.69), we deduce

$$\begin{aligned} |q_n^i|^2 &\leq \frac{c|F_n^i|^2}{(\kappa_0)^2} + \frac{C}{\kappa_0(\nu + \nu_r)} \left( \left\| \frac{v_n^i - v_n^{i-1}}{h} \right\|_{L^2(\sigma)}^2 + \|\mathbf{u}_n^i\|_{L^4(\sigma)^2}^2 \|v_n^i\|_{W^{1,2}(\sigma)}^2 \right) \\ &\quad + \frac{C}{\kappa_0(\nu + \nu_r)} \left( (2\nu_r)^2 \|\operatorname{rot}_{x'} \mathbf{w}_n^i\|_{L^2(\sigma)}^2 + \|f_n^i\|_{L^2(\sigma)}^2 \right). \end{aligned} \quad (2.70)$$

Note that there holds

$$\|\operatorname{rot}_{x'} \mathbf{w}_n^i\|_{L^2(\sigma)}^2 \leq C \|\mathbf{w}_n^i\|_{W^{1,2}(\sigma)^2}^2.$$

Combining (2.61) with (2.70), we arrive at the estimate

$$\begin{aligned} &\left( 1 - 2\varepsilon - hcC(\varepsilon) - \varepsilon \frac{C}{\kappa_0(\nu + \nu_r)} \right) \sum_{i=1}^k \left\| \frac{v_n^i - v_n^{i-1}}{h} \right\|_{L^2(\sigma)}^2 + \frac{\nu}{2h} \|\nabla_{x'} v_n^k\|_{L^2(\sigma)^2}^2 \\ &+ \frac{1}{h} \left( \frac{\nu}{2} - C\varepsilon \right) \sum_{i=1}^k \|\nabla_{x'} v_n^i - \nabla_{x'} v_n^{i-1}\|_{L^2(\sigma)^2}^2 + (1 - 2\varepsilon - hcC(\varepsilon)) \sum_{i=1}^k \left\| \frac{\mathbf{w}_n^i - \mathbf{w}_n^{i-1}}{h} \right\|_{L^2(\sigma)^2}^2 \\ &+ \frac{(c_a + c_d)}{2h} \int_{\sigma} |\nabla_{x'} \mathbf{w}_n^k|^2 dx' + \frac{1}{h} \left( \frac{c_a + c_d}{2} - C\varepsilon \right) \sum_{i=1}^k \int_{\sigma} |\nabla_{x'} \mathbf{w}_n^i - \nabla_{x'} \mathbf{w}_n^{i-1}|^2 dx' \\ &\leq \varepsilon \frac{C_1}{\kappa_0(\nu + \nu_r)} \sum_{i=1}^k \left( \|\mathbf{u}_n^i\|_{L^4(\sigma)^2}^2 \|v_n^i\|_{W^{1,2}(\sigma)}^2 + C_2 \nu_r^2 \|\mathbf{w}_n^i\|_{W^{1,2}(\sigma)^2}^2 \right) \\ &+ C(\varepsilon) \sum_{i=1}^k \|\mathbf{u}_n^i\|_{L^\infty(\sigma)^2}^2 \left( \|v_n^{i-1}\|_{W^{1,2}(\sigma)}^2 + \|\mathbf{w}_n^{i-1}\|_{W^{1,2}(\sigma)^2}^2 \right) + \frac{\varepsilon C}{(\kappa_0)^2} \sum_{i=1}^k |F_n^i|^2 \\ &+ \frac{c}{\varepsilon} \sum_{i=1}^k \left| \frac{F_n^i - F_n^{i-1}}{h} \right|^2 + \left( \frac{c}{\varepsilon} + \varepsilon \frac{C}{\kappa_0(\nu + \nu_r)} \right) \sum_{i=1}^k \|f_n^i\|_{L^2(\sigma)}^2 + \frac{c}{\varepsilon} \sum_{i=1}^k \|\mathbf{g}_n^i\|_{L^2(\sigma)^2}^2 \\ &\quad - \frac{2\nu_r}{h} ((\mathbf{w}_n^0, \nabla_{x'}^\perp v_n^0)) + \frac{2\nu_r}{h} \|\mathbf{w}_n^0\|_{L^2(\sigma)^2}^2 + \frac{(\nu + \nu_r)}{2h} \|\nabla_{x'} v_n^0\|_{L^2(\sigma)^2}^2 \\ &\quad + \frac{(c_a + c_d)}{2h} \int_{\sigma} |\nabla_{x'} \mathbf{w}_n^0|^2 dx' + \frac{(c_0 + c_d - c_a)}{2h} \|\operatorname{div}_{x'} \mathbf{w}_n^0\|_{L^2(\sigma)}^2. \end{aligned}$$

Finally, taking  $\varepsilon > 0$  “small enough” such that

$$\left( \frac{\nu}{2} - C\varepsilon \right) > 0, \quad \left( \frac{c_a + c_d}{2} - C\varepsilon \right) > 0,$$

and then taking  $h_0 > 0$  small enough such that (for all  $h < h_0$ )

$$\left(1 - 2\varepsilon - hcC(\varepsilon) - 2\varepsilon \frac{C}{\kappa_0(\nu + \nu_r)}\right) > 0, \quad \text{and} \quad (1 - 2\varepsilon - hcC(\varepsilon)) > 0,$$

we arrive at, for  $k = 1, 2, \dots, n$ ,

$$\begin{aligned} & \|v_n^k\|_{W^{1,2}(\sigma)}^2 + \|\mathbf{w}_n^k\|_{W^{1,2}(\sigma)^2}^2 + h \sum_{i=1}^k \left\| \frac{v_n^i - v_n^{i-1}}{h} \right\|_{L^2(\sigma)}^2 + h \sum_{i=1}^k \left\| \frac{\mathbf{w}_n^i - \mathbf{w}_n^{i-1}}{h} \right\|_{L^2(\sigma)^2}^2 \\ & \leq C_1 + C_2 h \sum_{i=1}^k \|\mathbf{u}_n^i\|_{L^\infty(\sigma)^2}^2 \left( \|v_n^{i-1}\|_{W^{1,2}(\sigma)}^2 + \|\mathbf{w}_n^{i-1}\|_{W^{1,2}(\sigma)^2}^2 \right) \\ & \quad + C_3 h \sum_{i=1}^k \left( \|v_n^i\|_{W^{1,2}(\sigma)}^2 + \|\mathbf{w}_n^i\|_{W^{1,2}(\sigma)^2}^2 \right). \end{aligned} \quad (2.71)$$

From the latter estimate we can write

$$\begin{aligned} & (1 - hC_3) \left( \|v_n^k\|_{W^{1,2}(\sigma)}^2 + \|\mathbf{w}_n^k\|_{W^{1,2}(\sigma)^2}^2 \right) \\ & \leq C_1 + C_2 h \|\mathbf{u}_n^1\|_{L^\infty(\sigma)^2}^2 \left( \|v_n^0\|_{W^{1,2}(\sigma)}^2 + \|\mathbf{w}_n^0\|_{W^{1,2}(\sigma)^2}^2 \right) \\ & \quad + h \sum_{i=1}^{k-1} (C_2 \|\mathbf{u}_n^{i+1}\|_{L^\infty(\sigma)^2}^2 + C_3) \left( \|v_n^i\|_{W^{1,2}(\sigma)}^2 + \|\mathbf{w}_n^i\|_{W^{1,2}(\sigma)^2}^2 \right). \end{aligned}$$

Now, assuming  $h_0 > 0$  small enough such that  $h_0 < 1/C_3$  we can write (for all  $h < h_0$ )

$$\|v_n^k\|_{W^{1,2}(\sigma)}^2 + \|\mathbf{w}_n^k\|_{W^{1,2}(\sigma)^2}^2 \leq c_1 + c_2 h \sum_{i=1}^{k-1} A_i \left( \|v_n^i\|_{W^{1,2}(\sigma)}^2 + \|\mathbf{w}_n^i\|_{W^{1,2}(\sigma)^2}^2 \right),$$

where

$$A_i = C_2 \|\mathbf{u}_n^{i+1}\|_{L^\infty(\sigma)^2}^2 + C_3.$$

Note that, in view of (2.31), we have

$$h \sum_{i=1}^{k-1} A_i < C,$$

where  $C$  is independent of  $h$ . Now, applying the discrete version of the Gronwall inequality (see [36, Theorem 1.46]) and obtain

$$\|v_n^k\|_{W^{1,2}(\sigma)}^2 \leq C, \quad k = 1, \dots, n, \quad (2.72)$$

$$\|\mathbf{w}_n^k\|_{W^{1,2}(\sigma)^2}^2 \leq C, \quad k = 1, \dots, n, \quad (2.73)$$

and from (2.71) we obtain

$$h \sum_{i=1}^k \left\| \frac{v_n^i - v_n^{i-1}}{h} \right\|_{L^2(\sigma)}^2 \leq C, \quad k = 1, \dots, n, \quad (2.74)$$

$$h \sum_{i=1}^k \left\| \frac{\mathbf{w}_n^i - \mathbf{w}_n^{i-1}}{h} \right\|_{L^2(\sigma)^2}^2 \leq C, \quad k = 1, \dots, n. \quad (2.75)$$

### 2.3.3 Temporal Interpolants and Uniform Estimates

We define the piecewise constant interpolants

$$\bar{\varphi}_n(t) = \varphi_n^i,$$

for  $t \in \langle (i-1)h, ih \rangle$  and, in addition, we extend  $\bar{\varphi}_n$  for  $t \leq 0$  by  $\bar{\varphi}_n(t) = \varphi_0$  for  $t \in \langle -h, 0 \rangle$ .

Furthermore, we define the piecewise linear time interpolants ( $i = 1, 2, \dots, n$ ) with

$$\phi_n(t) = \phi_n^{i-1} + \frac{t - (i-1)h}{h} (\phi_n^i - \phi_n^{i-1}),$$

for  $t \in \langle (i-1)h, ih \rangle$ . From (2.72)–(2.75) we have

$$\|\bar{v}_n(t)\|_{W^{1,2}(\sigma)}^2 \leq C, \quad \text{for all } t \in [0, T], \quad (2.76)$$

$$\|\bar{\mathbf{w}}_n(t)\|_{W^{1,2}(\sigma)^2}^2 \leq C, \quad \text{for all } t \in [0, T], \quad (2.77)$$

$$\int_0^T \|\partial_t v_n(t)\|_{L^2(\sigma)}^2 dt \leq C, \quad (2.78)$$

$$\int_0^T \|\partial_t \mathbf{w}_n(t)\|_{L^2(\sigma)^2}^2 dt \leq C. \quad (2.79)$$

Now, in view of (2.70), we have

$$\int_0^T |\bar{q}_n(t)|^2 dt \leq C. \quad (2.80)$$

### 2.3.4 Passage to the Limit

Following (2.32)–(2.34), the time interpolants  $\bar{v}_n \in L^\infty(0, T; W_0^{1,2}(\sigma))$ ,  $\bar{\mathbf{w}}_n \in L^\infty(0, T; W_0^{1,2}(\sigma)^2)$ ,  $v_n \in W^{1,2}(0, T; L^2(\sigma))$ ,  $\mathbf{w}_n \in W^{1,2}(0, T; L^2(\sigma)^2)$ ,  $\bar{q}_n \in L^\infty(\langle 0, T \rangle)$  satisfy the equations

$$\begin{aligned} & \frac{d}{dt}(v_n(t), \varphi) + (\nu + \nu_r)((\nabla_{x'} \bar{v}_n(t), \nabla_{x'} \varphi)) + d(\bar{\mathbf{u}}_n(t), \bar{v}_n(t), \varphi) \\ & = \bar{q}_n(t)(1, \varphi) + 2\nu_r(\text{rot}_{x'} \bar{\mathbf{w}}_n(t), \varphi) + (\bar{f}_n(t), \varphi), \end{aligned} \quad (2.81)$$

for all  $\varphi \in W_0^{1,2}(\sigma)$ ,

$$\begin{aligned} & \frac{d}{dt}((\mathbf{w}_n(t), \boldsymbol{\psi})) + (c_a + c_d)a(\bar{\mathbf{w}}_n(t), \boldsymbol{\psi}) + b(\bar{\mathbf{u}}_n(t), \bar{\mathbf{w}}_n(t), \boldsymbol{\psi}) \\ & + (c_0 + c_d - c_a)(\text{div}_{x'} \bar{\mathbf{w}}_n(t), \text{div}_{x'} \boldsymbol{\psi}) + 4\nu_r((\bar{\mathbf{w}}_n(t), \boldsymbol{\psi})) \\ & = 2\nu_r((\nabla_{x'}^\perp \bar{v}_n(t), \boldsymbol{\psi})) + ((\bar{\mathbf{g}}_n(t), \boldsymbol{\psi})), \end{aligned} \quad (2.82)$$

for all  $\psi \in W_0^{1,2}(\sigma)^2$  and for almost every  $t \in \langle 0, T \rangle$ , and the flux condition

$$\int_{\sigma} \bar{v}_n(t) \, dx' = \bar{F}_n(t) \quad \text{for all } t \in \langle 0, T \rangle. \quad (2.83)$$

The apriori estimates (2.76)–(2.80) allow us to conclude that there exist  $v \in L^2(0, T; W_0^{1,2}(\sigma))$ ,  $\hat{\mathbf{w}} \in L^2(0, T; W_0^{1,2}(\sigma)^2)$  and  $q \in L^2(\langle 0, T \rangle)$  such that, letting  $n \rightarrow +\infty$  (along a selected subsequence),

$$\bar{v}_n \rightharpoonup v \quad \text{weakly* in } L^\infty(0, T; W_0^{1,2}(\sigma)), \quad (2.84)$$

$$\bar{\mathbf{w}}_n \rightharpoonup \hat{\mathbf{w}} \quad \text{weakly* in } L^\infty(0, T; W_0^{1,2}(\sigma)^2), \quad (2.85)$$

$$\partial_t v_n \rightharpoonup \partial_t v \quad \text{weakly in } L^2(0, T; L^2(\sigma)), \quad (2.86)$$

$$\partial_t \mathbf{w}_n \rightharpoonup \partial_t \hat{\mathbf{w}} \quad \text{weakly in } L^2(0, T; L^2(\sigma)^2), \quad (2.87)$$

$$\bar{q}_n \rightharpoonup q \quad \text{weakly in } L^2(\langle 0, T \rangle). \quad (2.88)$$

The above established convergences (2.84)–(2.88) are sufficient for taking the limit  $n \rightarrow \infty$  in (2.81), (2.82) and (2.83) (along a selected subsequence) to get the weak solution of the system (2.9)–(2.10) in the sense of Definition 2.4 on  $\langle 0, T \rangle$ ,  $T \in \langle 0, +\infty \rangle$ .

### 2.3.5 Solvability of Problem (2.9)–(2.10) on $\langle 0, \infty \rangle$

Using  $\varphi = v$  as a test function in equation (2.26),  $\psi = \hat{\mathbf{w}}$  as a test function in equation (2.27) and integrating from 0 to  $s$  we obtain, in particular,

$$\begin{aligned} & \frac{1}{2} \|v(s)\|_{L^2(\sigma)}^2 + (\nu + \nu_r) \int_0^s \|\nabla_{x'} v(t)\|_{L^2(\sigma)^2}^2 dt + \int_0^s d(\hat{\mathbf{u}}(t), v(t), v(t)) dt \\ &= \frac{1}{2} \|a\|_{L^2(\sigma)}^2 + \int_0^s q(t) F(t) dt + 2\nu_r \int_0^s (\text{rot}_{x'} \hat{\mathbf{w}}(t), v(t)) dt + \int_0^s (f(t), v(t)) dt, \end{aligned} \quad (2.89)$$

and

$$\begin{aligned} & \frac{1}{2} \|\hat{\mathbf{w}}(s)\|_{L^2(\sigma)^2}^2 + (c_a + c_d) \int_0^s a(\hat{\mathbf{w}}(t), \hat{\mathbf{w}}(t)) dt + \int_0^s b(\hat{\mathbf{u}}(t), \hat{\mathbf{w}}(t), \hat{\mathbf{w}}(t)) dt \\ & \quad + (c_0 + c_d - c_a) \int_0^s \|\text{div}_{x'} \hat{\mathbf{w}}(t)\|_{L^2(\sigma)}^2 dt + 4\nu_r \int_0^s \|\hat{\mathbf{w}}(t)\|_{L^2(\sigma)^2}^2 dt \\ &= \frac{1}{2} \|\hat{\mathbf{b}}\|_{L^2(\sigma)^2}^2 + 2\nu_r \int_0^s ((\nabla_{x'}^\perp v(t), \hat{\mathbf{w}}(t))) dt + \int_0^s ((\hat{\mathbf{g}}(t), \hat{\mathbf{w}}(t))) dt. \end{aligned} \quad (2.90)$$

We recall that

$$\int_0^s ((\text{rot}_{x'} \hat{\mathbf{w}}(t), v(t))) dt = \int_0^s ((\nabla_{x'}^\perp v(t), \hat{\mathbf{w}}(t))) dt, \quad (2.91)$$

and that there also holds

$$\left| \int_0^s ((\nabla_{x'}^\perp v(t), \hat{\mathbf{w}}(t))) dt \right| \leq \frac{1}{4} \int_0^s \|\nabla_{x'} v(t)\|_{L^2(\sigma)^2}^2 dt + \int_0^s \|\hat{\mathbf{w}}(t)\|_{L^2(\sigma)^2}^2 dt. \quad (2.92)$$

Furthermore, we have

$$\begin{aligned} \left| \int_0^s d(\hat{\mathbf{u}}(t), v(t), v(t)) dt \right| &\leq c \int_0^s \|\hat{\mathbf{u}}(t)\|_{L^4(\sigma)^2} \|v(t)\|_{W^{1,2}(\sigma)} \|v(t)\|_{L^4(\sigma)} dt \\ &\leq C(\varepsilon) \int_0^s \|\hat{\mathbf{u}}(t)\|_{L^4(\sigma)^2}^4 \|v(t)\|_{L^2(\sigma)}^2 dt + \varepsilon \int_0^s \|v(t)\|_{W^{1,2}(\sigma)}^2 dt, \end{aligned} \quad (2.93)$$

and

$$\begin{aligned} \left| \int_0^s b(\hat{\mathbf{u}}(t), \hat{\mathbf{w}}(t), \hat{\mathbf{w}}(t)) dt \right| &\leq c \int_0^s \|\hat{\mathbf{u}}(t)\|_{L^4(\sigma)^2} \|\hat{\mathbf{w}}(t)\|_{W^{1,2}(\sigma)^2} \|\hat{\mathbf{w}}(t)\|_{L^4(\sigma)^2} dt \\ &\leq C(\varepsilon) \int_0^s \|\hat{\mathbf{u}}(t)\|_{L^4(\sigma)^2}^4 \|\hat{\mathbf{w}}(t)\|_{L^2(\sigma)^2}^2 dt + \varepsilon \int_0^s \|\hat{\mathbf{w}}(t)\|_{W^{1,2}(\sigma)^2}^2 dt. \end{aligned} \quad (2.94)$$

Combining (2.89)–(2.94) we obtain

$$\begin{aligned} &\frac{1}{2} \|v(s)\|_{L^2(\sigma)}^2 + \frac{1}{2} \|\hat{\mathbf{w}}(s)\|_{L^2(\sigma)^2}^2 \\ &+ (\nu + \nu_r) \int_0^s \|\nabla_{x'} v(t)\|_{L^2(\sigma)^2}^2 dt + (c_a + c_d) \int_0^s a(\hat{\mathbf{w}}(t), \hat{\mathbf{w}}(t)) dt \\ &+ (c_0 + c_d - c_a) \int_0^s \|\operatorname{div}_{x'} \hat{\mathbf{w}}(t)\|_{L^2(\sigma)}^2 dt + 4\nu_r \int_0^s \|\hat{\mathbf{w}}(t)\|_{L^2(\sigma)^2}^2 dt \\ &\leq \frac{1}{2} \|a\|_{L^2(\sigma)}^2 + \frac{1}{2} \|\hat{\mathbf{b}}\|_{L^2(\sigma)^2}^2 + \nu_r \int_0^s \|\nabla_{x'} v(t)\|_{L^2(\sigma)^2}^2 dt + 4\nu_r \int_0^s \|\hat{\mathbf{w}}(t)\|_{L^2(\sigma)^2}^2 dt \\ &+ \xi \int_0^s \|v(t)\|_{W^{1,2}(\sigma)}^2 dt + c_1(\xi) \int_0^s \|\hat{\mathbf{u}}(t)\|_{L^4(\sigma)^2}^4 \|v(t)\|_{L^2(\sigma)}^2 dt + \xi \int_0^s \|\hat{\mathbf{w}}(t)\|_{W^{1,2}(\sigma)^2}^2 dt \\ &+ c_2(\xi) \int_0^s \|\hat{\mathbf{u}}(t)\|_{L^4(\sigma)^2}^4 \|\hat{\mathbf{w}}(t)\|_{L^2(\sigma)^2}^2 dt + \xi \int_0^s |q(t)|^2 dt + c_3(\xi) \int_0^s |F(t)|^2 dt \\ &+ \xi \left( \int_0^s \|\hat{\mathbf{w}}(t)\|_{L^2(\sigma)^2}^2 dt + \int_0^s \|v(t)\|_{L^2(\sigma)}^2 dt \right) \\ &+ c_4(\xi) \left( \int_0^s \|\hat{\mathbf{g}}(t)\|_{L^2(\sigma)^2}^2 dt + \int_0^s \|f(t)\|_{L^2(\sigma)}^2 dt \right), \end{aligned}$$

where  $\xi$  is an “arbitrarily small” positive real number. Applying the Friedrichs inequality, the latter estimate can be further simplified as

$$\begin{aligned} &\|v(s)\|_{L^2(\sigma)}^2 + \|\hat{\mathbf{w}}(s)\|_{L^2(\sigma)^2}^2 + \int_0^s \|v(t)\|_{W^{1,2}(\sigma)}^2 dt + \int_0^s \|\hat{\mathbf{w}}(t)\|_{W^{1,2}(\sigma)^2}^2 dt \\ &\leq c_1(\xi) \left( \|a\|_{L^2(\sigma)}^2 + \|\hat{\mathbf{b}}\|_{L^2(\sigma)^2}^2 \right) + c_2(\xi) \int_0^s \|\hat{\mathbf{u}}(t)\|_{L^4(\sigma)^2}^4 \left( \|v(t)\|_{L^2(\sigma)}^2 + \|\hat{\mathbf{w}}(t)\|_{L^2(\sigma)^2}^2 \right) dt \\ &+ \xi \int_0^s |q(t)|^2 dt + c_3(\xi) \int_0^s |F(t)|^2 dt + c_4(\xi) \left( \int_0^s \|\hat{\mathbf{g}}(t)\|_{L^2(\sigma)^2}^2 dt + \int_0^s \|f(t)\|_{L^2(\sigma)}^2 dt \right). \end{aligned} \quad (2.95)$$

Moreover, in view of [33, Theorem 2.7, eq. (2.74)], we have

$$\begin{aligned} & \|\partial_t v\|_{L^2(0,s;L^2(\sigma))}^2 + \|v\|_{L^\infty(0,s;W^{1,2}(\sigma))}^2 + \|v\|_{L^2(0,s;W^{2,2}(\sigma))}^2 + \|q\|_{L^2((0,s))}^2 \\ & \leq c \left( \|\text{rot}_{x'} \hat{\mathbf{w}}\|_{L^2(0,s;L^2(\sigma))}^2 + \|(\hat{\mathbf{u}} \cdot \nabla_{x'}) v\|_{L^2(0,s;L^2(\sigma))}^2 \right) \\ & \quad + c \left( \|f\|_{L^2(0,s;L^2(\sigma))}^2 + \|F\|_{W^{1,2}((0,s))}^2 + \|a\|_{W^{1,2}(\sigma)}^2 \right), \end{aligned} \quad (2.96)$$

where  $c$  does not depend on  $s$ .

Using the Sobolev embedding and the interpolation inequality [17, 20] we have

$$\|v\|_{W^{1,4}(\sigma)} \leq c_1 \|v\|_{W^{3/2,2}(\sigma)} \leq c_2 \|v\|_{W^{1,2}(\sigma)}^{1/2} \|v\|_{W^{2,2}(\sigma)}^{1/2}.$$

Furthermore, we can write

$$\begin{aligned} \|(\hat{\mathbf{u}} \cdot \nabla_{x'}) v\|_{L^2(0,s;L^2(\sigma))}^2 & \leq c_1(\sigma) \int_0^s \|\hat{\mathbf{u}}(t)\|_{L^4(\sigma)^2}^2 \|v(t)\|_{W^{1,4}(\sigma)}^2 dt \\ & \leq c_1(\sigma) \int_0^s \|\hat{\mathbf{u}}(t)\|_{L^4(\sigma)^2}^2 \left( c_2(\delta) \|v(t)\|_{W^{1,2}(\sigma)}^2 + \delta \|v(t)\|_{W^{2,2}(\sigma)}^2 \right) dt \\ & \leq c_1(\sigma) c_2(\delta) \|\hat{\mathbf{u}}\|_{L^\infty(0,s;L^4(\sigma)^2)}^2 \|v\|_{L^2(0,s;W^{1,2}(\sigma))}^2 \\ & \quad + c_1(\sigma) \delta \|\hat{\mathbf{u}}\|_{L^\infty(0,s;L^4(\sigma)^2)}^2 \|v\|_{L^2(0,s;W^{2,2}(\sigma))}^2. \end{aligned} \quad (2.97)$$

Note that

$$\|\hat{\mathbf{u}}\|_{L^\infty(0,s;L^4(\sigma)^2)}^2 \leq c \|\hat{\mathbf{u}}\|_{L^\infty(0,s;W^{1,2}(\sigma)^2)}^2 \leq c \|\hat{\mathbf{u}}\|_{L^\infty(0,\infty;W^{1,2}(\sigma)^2)}^2 \leq C,$$

where  $C$  is independent of  $s$ .

Therefore, using (2.97) in (2.96) and taking  $\delta$  small enough we deduce

$$\begin{aligned} \|q\|_{L^2((0,s))}^2 & \leq c \left( \|\hat{\mathbf{w}}\|_{L^2(0,s;W^{1,2}(\sigma)^2)}^2 + \|v\|_{L^2(0,s;W^{1,2}(\sigma))}^2 \right) \\ & \quad + c \left( \|f\|_{L^2(0,s;L^2(\sigma))}^2 + \|F\|_{W^{1,2}((0,s))}^2 + \|a\|_{W^{1,2}(\sigma)}^2 \right). \end{aligned} \quad (2.98)$$

Now, substituting (2.98) into (2.95) and taking  $\xi$  “small” enough we obtain

$$\begin{aligned} & \|v(s)\|_{L^2(\sigma)}^2 + \|\hat{\mathbf{w}}(s)\|_{L^2(\sigma)^2}^2 + \|v\|_{L^2(0,s;W^{1,2}(\sigma))}^2 + \|\hat{\mathbf{w}}\|_{L^2(0,s;W^{1,2}(\sigma)^2)}^2 \\ & \leq c_1 \left( \|a\|_{L^2(\sigma)}^2 + \|a\|_{W^{1,2}(\sigma)}^2 + \|\hat{\mathbf{b}}\|_{L^2(\sigma)^2}^2 \right) \\ & \quad + c_2 \left( \|f\|_{L^2(0,s;L^2(\sigma))}^2 + \|\hat{\mathbf{g}}\|_{L^2(0,s;L^2(\sigma)^2)}^2 + \|F\|_{W^{1,2}((0,s))}^2 \right) \\ & \quad + c_3 \int_0^s \|\hat{\mathbf{u}}(t)\|_{L^4(\sigma)^2}^4 \left( \|v(t)\|_{L^2(\sigma)}^2 + \|\hat{\mathbf{w}}(t)\|_{L^2(\sigma)^2}^2 \right) dt. \end{aligned} \quad (2.99)$$

Note that (2.99) holds for all  $s \geq 0$ . Furthermore, introducing the notation

$$\begin{aligned} C_1 &= c_1 \left( \|a\|_{L^2(\sigma)}^2 + \|a\|_{W^{1,2}(\sigma)}^2 + \|\hat{\mathbf{b}}\|_{L^2(\sigma^2)}^2 \right), \\ \chi(s) &= c_2 \left( \|f\|_{L^2(0,s;L^2(\sigma))}^2 + \|\hat{\mathbf{g}}\|_{L^2(0,s;L^2(\sigma^2))}^2 + \|F\|_{W^{1,2}((0,s))}^2 \right), \\ C_2 &= C_1 + \chi(+\infty), \end{aligned}$$

the inequality (2.99) can be simplified as

$$\|v(s)\|_{L^2(\sigma)}^2 + \|\hat{\mathbf{w}}(s)\|_{L^2(\sigma^2)}^2 \leq C_2 + \int_0^s c_3 \|\hat{\mathbf{u}}(t)\|_{L^4(\sigma^2)}^4 \left( \|v(t)\|_{L^2(\sigma)}^2 + \|\hat{\mathbf{w}}(t)\|_{L^2(\sigma^2)}^2 \right) dt.$$

Applying the Gronwall inequality we arrive at

$$\|v(s)\|_{L^2(\sigma)}^2 + \|\hat{\mathbf{w}}(s)\|_{L^2(\sigma^2)}^2 \leq C_2 \exp \int_0^s c_3 \|\hat{\mathbf{u}}(t)\|_{L^4(\sigma^2)}^4 dt. \quad (2.100)$$

Recall that we assume  $\hat{\mathbf{u}} \in L^2(0, \infty; W^{2,2}(\sigma^2)) \cap L^\infty(0, \infty; V)$  (see (2.22)). Raising and integrating the interpolation inequality [1, Theorem 5.8]

$$\|\hat{\mathbf{u}}(t)\|_{L^4(\sigma^2)} \leq c \|\hat{\mathbf{u}}(t)\|_{W^{1,2}(\sigma^2)}^{1/2} \|\hat{\mathbf{u}}(t)\|_{L^2(\sigma^2)}^{1/2},$$

from 0 to  $s$  we get

$$\begin{aligned} \left( \int_0^s \|\hat{\mathbf{u}}(t)\|_{L^4(\sigma^2)}^4 dt \right)^{1/4} &\leq c \left( \int_0^s \|\hat{\mathbf{u}}(t)\|_{L^2(\sigma^2)}^2 \|\hat{\mathbf{u}}(t)\|_{W^{1,2}(\sigma^2)}^2 dt \right)^{1/4} \\ &\leq c \|\hat{\mathbf{u}}\|_{L^2(0,s;L^2(\sigma^2))}^{1/2} \|\hat{\mathbf{u}}\|_{L^\infty(0,s;W^{1,2}(\sigma^2))}^{1/2} \\ &\leq c \|\hat{\mathbf{u}}\|_{L^2(0,s;W^{2,2}(\sigma^2))}^{1/2} \|\hat{\mathbf{u}}\|_{L^\infty(0,s;W^{1,2}(\sigma^2))}^{1/2}, \end{aligned}$$

where  $c = c(\sigma)$ . Now, letting  $s \rightarrow \infty$  we get  $\hat{\mathbf{u}} \in L^4(0, \infty; L^4(\sigma^2))$  and from (2.100) we have

$$\|v(s)\|_{L^2(\sigma)}^2 + \|\hat{\mathbf{w}}(s)\|_{L^2(\sigma^2)}^2 \leq c,$$

for all  $s$  and  $c$  does not depend on  $s$ . Hence, from (2.99) we further deduce

$$\|v\|_{L^2(0,s;W^{1,2}(\sigma))}^2 + \|\hat{\mathbf{w}}\|_{L^2(0,s;W^{1,2}(\sigma^2))}^2 \leq C_2 + c \int_0^s \|\hat{\mathbf{u}}(t)\|_{L^4(\sigma^2)}^4 dt,$$

and, finally, letting  $s \rightarrow +\infty$ ,

$$\|v\|_{L^2(0,\infty;W_0^{1,2}(\sigma))}^2 + \|\hat{\mathbf{w}}\|_{L^2(0,\infty;W_0^{1,2}(\sigma^2))}^2 \leq c. \quad (2.101)$$

Now, in view of (2.20) (with  $T = +\infty$ ) and (2.101) we have

$$2\nu_r(\operatorname{rot}_{x'} \hat{\mathbf{w}}, \cdot) + (f, \cdot) - d(\hat{\mathbf{u}}, v, \cdot) \in L^2(0, \infty; L^2(\sigma)).$$

Moreover, using [33, Theorem 2.7, eq. (2.74)], we deduce

$$\begin{aligned} & \|\partial_t v\|_{L^2(0,\infty;L^2(\sigma))}^2 + \|v\|_{L^\infty(0,\infty;W_0^{1,2}(\sigma))}^2 + \|q(\tau)\|_{L^2((0,\infty))}^2 \\ & \leq c \left( \|f\|_{L^2(0,\infty;L^2(\sigma))}^2 + \|\operatorname{rot}_{x'} \hat{\mathbf{w}}\|_{L^2(0,\infty;L^2(\sigma))}^2 \right) \\ & + c \left( \|d(\hat{\mathbf{u}}, v, \cdot)\|_{L^2(0,\infty;L^2(\sigma))}^2 + \|F\|_{W^{1,2}((0,\infty))}^2 + \|a\|_{W_0^{1,2}(\sigma)}^2 \right). \end{aligned}$$

On the other hand, with  $v \in L^2(0, \infty; W_0^{1,2}(\sigma))$  and  $\hat{\mathbf{w}} \in L^2(0, \infty; W_0^{1,2}(\sigma)^2)$  in hand, we rewrite (2.27) as

$$\begin{aligned} & \frac{d}{dt}((\hat{\mathbf{w}}(t), \boldsymbol{\psi})) + (c_a + c_d)a(\hat{\mathbf{w}}(t), \boldsymbol{\psi}) + (c_0 + c_d - c_a)(\operatorname{div}_{x'} \hat{\mathbf{w}}(t), \operatorname{div}_{x'} \boldsymbol{\psi}) \\ & = 2\nu_r((\nabla_{x'}^\perp v(t), \boldsymbol{\psi})) + ((\hat{\mathbf{g}}(t), \boldsymbol{\psi})) - 4\nu_r((\hat{\mathbf{w}}(t), \boldsymbol{\psi})) - b(\hat{\mathbf{u}}(t), \hat{\mathbf{w}}(t), \boldsymbol{\psi}), \end{aligned}$$

for all  $\boldsymbol{\psi} \in W_0^{1,2}(\sigma)^2$  and for almost every  $t \in \langle 0, T \rangle$  and  $\hat{\mathbf{w}}(x', 0) = \hat{\mathbf{b}}(x')$ .

In view of (2.20), (2.23) and (2.101) we have

$$2\nu_r((\nabla_{x'}^\perp v, \cdot)) + ((\hat{\mathbf{g}}, \cdot)) - 4\nu_r((\hat{\mathbf{w}}, \cdot)) - b(\hat{\mathbf{u}}, \hat{\mathbf{w}}, \cdot) \in L^2(0, \infty; L^2(\sigma)^2).$$

Note that the bilinear form  $\gamma(\cdot, \cdot)$ , defined by the equation

$$\gamma(\boldsymbol{\phi}, \boldsymbol{\psi}) := (c_a + c_d)a(\boldsymbol{\phi}, \boldsymbol{\psi}) + (c_0 + c_d - c_a)(\operatorname{div}_{x'} \boldsymbol{\phi}, \operatorname{div}_{x'} \boldsymbol{\psi}),$$

for all  $\boldsymbol{\phi}, \boldsymbol{\psi} \in W_0^{1,2}(\sigma)^2$ , is symmetric and positive definite. Hence, we have

$$\partial_t \hat{\mathbf{w}} \in L^2(0, \infty; L^2(\sigma)^2), \quad \hat{\mathbf{w}} \in L^\infty(0, \infty; W_0^{1,2}(\sigma)^2),$$

such that

$$\begin{aligned} & \|\partial_t \hat{\mathbf{w}}\|_{L^2(0,\infty;L^2(\sigma)^2)}^2 + \|\hat{\mathbf{w}}\|_{L^\infty(0,\infty;W_0^{1,2}(\sigma)^2)}^2 \leq c \left( \|\nabla_{x'}^\perp v\|_{L^2(0,\infty;L^2(\sigma)^2)}^2 + \|\hat{\mathbf{w}}\|_{L^2(0,\infty;L^2(\sigma)^2)}^2 \right) \\ & + c \left( \|b(\hat{\mathbf{u}}(t), \hat{\mathbf{w}}(t), \cdot)\|_{L^2(0,\infty;L^2(\sigma)^2)}^2 + \|\hat{\mathbf{g}}\|_{L^2(0,\infty;L^2(\sigma)^2)}^2 + \|\hat{\mathbf{b}}\|_{W_0^{1,2}(\sigma)^2}^2 \right) \leq C, \end{aligned}$$

see Theorem 2.8. The proof of Theorem 2.5 is thus complete.



## 2.4 Existence and Uniqueness Result for the Coupled Problem (2.8)–(2.10)

Here we present the existence and uniqueness result for the solution of the coupled problem (2.8)–(2.10).

**Theorem 2.7.** *Let  $T \in \langle 0, \infty \rangle$  and suppose that*

$$\begin{aligned}\hat{\mathbf{f}} &\in L^2(0, T; H), \quad g \in L^2(0, T; L^2(\sigma)), \\ \hat{\mathbf{a}} &\in V, \quad b \in W_0^{1,2}(\sigma),\end{aligned}$$

and

$$\begin{aligned}\hat{\mathbf{g}} &\in L^2(0, T; L^2(\sigma)^2), \quad f \in L^2(0, T; L^2(\sigma)), \quad F \in W^{1,2}(\langle 0, T \rangle), \\ \hat{\mathbf{b}} &\in W_0^{1,2}(\sigma)^2, \quad a \in W_0^{1,2}(\sigma).\end{aligned}$$

Then there exist the pair  $[\hat{\mathbf{u}}, \omega]$ , such that

$$\hat{\mathbf{u}} \in L^\infty(0, T; V) \cap W^{1,2}(0, T; H), \quad (2.102)$$

$$\omega \in L^\infty(0, T; W_0^{1,2}(\sigma)) \cap W^{1,2}(0, T; L^2(\sigma)) \quad (2.103)$$

and the triple  $[v, \hat{\mathbf{w}}, q]$ , such that

$$\begin{aligned}v &\in L^\infty(0, T; W_0^{1,2}(\sigma)) \cap W^{1,2}(0, T; L^2(\sigma)), \\ \hat{\mathbf{w}} &\in L^\infty(0, T; W_0^{1,2}(\sigma)^2) \cap W^{1,2}(0, T; L^2(\sigma)^2), \\ q &\in L^2(\langle 0, T \rangle),\end{aligned}$$

satisfying (2.16)–(2.19) and (2.25)–(2.28), respectively, for almost every  $t \in \langle 0, T \rangle$ . The solution to the coupled problem (2.8)–(2.10) is also globally unique.

*Proof.* The existence of  $[\hat{\mathbf{u}}, \omega]$  satisfying (2.102) and (2.103) follows directly from Theorem 2.2 and Theorem 2.3. With  $[\hat{\mathbf{u}}, \omega]$  in hand, the existence of  $[v, \hat{\mathbf{w}}, q]$  follows from Theorem 2.5.

Note that the uniqueness result for the two-dimensional system of Navier-Stokes equations is a classical result (see e.g. [40]). The uniqueness of the weak solution  $[\hat{\mathbf{u}}, \omega]$  to the problem (2.8) can be found in [21]. Now, suppose that there are two solutions  $[v_1, \hat{\mathbf{w}}_1, q_1]$  and  $[v_2, \hat{\mathbf{w}}_2, q_2]$  of the problem (2.25)–(2.28) on  $\langle 0, +\infty \rangle$ . Denote  $v_{12} = v_1 - v_2$ ,  $\hat{\mathbf{w}}_{12} = \hat{\mathbf{w}}_1 - \hat{\mathbf{w}}_2$  and  $q_{12} = q_1 - q_2$ . Then there holds  $v_{12}(x', 0) = 0$  and  $\hat{\mathbf{w}}_{12}(x', 0) = \mathbf{0}$ , with  $v_{12}$ ,  $\hat{\mathbf{w}}_{12}$  and

$q_{12}$  satisfying the equations

$$\begin{aligned} \frac{d}{dt}(v_{12}(t), \varphi) + (\nu + \nu_r)((\nabla_{x'} v_{12}(t), \nabla_{x'} \varphi)) + d(\hat{\mathbf{u}}(t), v_{12}(t), \varphi) \\ = q_{12}(t)(1, \varphi) + 2\nu_r(\text{rot}_{x'} \hat{\mathbf{w}}_{12}(t), \varphi), \end{aligned} \quad (2.104)$$

for all  $\varphi \in W_0^{1,2}(\sigma)$ ,

$$\begin{aligned} \frac{d}{dt}((\hat{\mathbf{w}}_{12}(t), \boldsymbol{\psi})) + (c_a + c_d)a(\hat{\mathbf{w}}_{12}(t), \boldsymbol{\psi}) + b(\hat{\mathbf{u}}(t), \hat{\mathbf{w}}_{12}(t), \boldsymbol{\psi}) \\ + (c_0 + c_d - c_a)(\text{div}_{x'} \hat{\mathbf{w}}_{12}(t), \text{div}_{x'} \boldsymbol{\psi}) + 4\nu_r((\hat{\mathbf{w}}_{12}(t), \boldsymbol{\psi})) = 2\nu_r((\nabla_{x'}^\perp v_{12}(t), \boldsymbol{\psi})), \end{aligned} \quad (2.105)$$

for all  $\boldsymbol{\psi} \in W_0^{1,2}(\sigma)^2$  and for a.e.  $t \in \langle 0, +\infty \rangle$ ; as well as the flux condition

$$\int_\sigma v_{12}(x', t) dx' = 0 \quad \text{on } \langle 0, \infty \rangle.$$

Hence substituting  $\varphi = v_{12}$  and  $\boldsymbol{\psi} = \hat{\mathbf{w}}_{12}$  in relations (2.104)–(2.105) and integrating from 0 to  $s$ , we obtain

$$\begin{aligned} \frac{1}{2} \|v_{12}(t)\|_{L^2(\sigma)}^2 + (\nu + \nu_r) \int_0^s \|\nabla_{x'} v_{12}(t)\|_{L^2(\sigma)^2}^2 dt + \int_0^s d(\hat{\mathbf{u}}(t), v_{12}(t), v_{12}(t)) dt \\ = \frac{1}{2} \|v_{12}(0)\|_{L^2(\sigma)}^2 + \int_0^s q_{12}(t) \underbrace{\int_\sigma v_{12} dx'}_{=0} dt + 2\nu_r \int_0^s (\text{rot}_{x'} \hat{\mathbf{w}}_{12}(t), v_{12}(t)) dt, \end{aligned} \quad (2.106)$$

and

$$\begin{aligned} \frac{1}{2} \|\hat{\mathbf{w}}_{12}(t)\|_{L^2(\sigma)^2}^2 - \frac{1}{2} \|\hat{\mathbf{w}}_{12}(0)\|_{L^2(\sigma)^2}^2 + (c_a + c_d) \int_0^s \int_\sigma |\nabla_{x'} \hat{\mathbf{w}}_{12}|^2 dx' dt \\ + \int_0^s b(\hat{\mathbf{u}}(t), \hat{\mathbf{w}}_{12}(t), \hat{\mathbf{w}}_{12}(t)) dt + (c_0 + c_d - c_a) \int_0^s \|\text{div}_{x'} \hat{\mathbf{w}}_{12}(t)\|_{L^2(\sigma)^2}^2 dt \\ + 4\nu_r \int_0^s \|\hat{\mathbf{w}}_{12}(t)\|_{L^2(\sigma)^2}^2 dt = 2\nu_r \int_0^s ((\nabla_{x'}^\perp v_{12}(t), \hat{\mathbf{w}}_{12}(t))) dt. \end{aligned} \quad (2.107)$$

Now, combining (2.106) and (2.107) and using (2.39), we obtain

$$\begin{aligned} \|v_{12}(t)\|_{L^2(\sigma)}^2 + \int_0^s \|v_{12}(t)\|_{W_0^{1,2}(\sigma)}^2 dt + \|\hat{\mathbf{w}}_{12}(t)\|_{L^2(\sigma)^2}^2 + \int_0^s \|\hat{\mathbf{w}}_{12}(t)\|_{W_0^{1,2}(\sigma)^2}^2 dt \\ \leq C \left( \|v_{12}(0)\|_{L^2(\sigma)}^2 + \|\hat{\mathbf{w}}_{12}(0)\|_{W_0^{1,2}(\sigma)^2}^2 \right), \end{aligned}$$

on  $\langle 0, +\infty \rangle$ . Now the uniqueness follows from the fact that  $v_{12}(0) = 0$  and  $\hat{\mathbf{w}}_{12}(0) = \mathbf{0}$ . The proof is thus complete.  $\square$

## 2.5 Solvability of Parabolic Systems in Hilbert Spaces

In the following, we present the well-known result concerning the solvability and  $L^2$ -regularity of parabolic problems.

### Theorem 2.8.

Let  $\sigma$  be a bounded domain in  $\mathbb{R}^2$ ,  $\sigma \in C^{0,1}$ ,  $T \in \langle 0, +\infty \rangle$ . Let  $\mathbf{f} \in L^2(0, T; L^2(\sigma)^2)$  and  $\mathbf{a} \in W_0^{1,2}(\sigma)^2$ . Let  $\mathbf{a}$  be a continuous, coercive and symmetric bilinear form on  $W_0^{1,2}(\sigma)^2$ . Let the form  $((\cdot, \cdot))$  be defined by (2.14).

There exists the unique  $\mathbf{v} \in L^\infty(0, T; W_0^{1,2}(\sigma)^2) \cap W^{1,2}(0, T; L^2(\sigma)^2)$  such that

$$((\mathbf{v}'(t), \boldsymbol{\psi})) + \mathbf{a}(\mathbf{v}(t), \boldsymbol{\psi})) = ((\mathbf{f}(t), \boldsymbol{\psi})), \quad (2.108)$$

for every  $\boldsymbol{\psi} \in W_0^{1,2}(\sigma)^2$  and for almost every  $t \in \langle 0, T \rangle$ , and

$$\mathbf{v}(0) = \mathbf{a}.$$

Moreover, the following estimate holds

$$\|\mathbf{v}\|_{L^\infty(0, T; W_0^{1,2}(\sigma)^2)} + \|\mathbf{v}'\|_{L^2(0, T; L^2(\sigma)^2)} \leq c \left( \|\mathbf{f}\|_{L^2(0, T; L^2(\sigma)^2)} + \|\mathbf{a}\|_{W_0^{1,2}(\sigma)^2} \right), \quad (2.109)$$

where  $c$  is independent of  $T$ .

*Proof.* Here we follow [40, Chapter III] (see also [4, Section 3, Theorem 3.4]). It can be shown as in [40, Chapter I] that there exist functions  $\boldsymbol{\phi}_1, \boldsymbol{\phi}_2, \dots, \boldsymbol{\phi}_k, \dots \in W_0^{1,2}(\sigma)^2 \subset L^2(\sigma)^2$  and real positive numbers  $\lambda_1, \lambda_2, \dots, \lambda_k, \dots \rightarrow \infty$  for  $k \rightarrow \infty$ , such that

$$\mathbf{a}(\boldsymbol{\phi}_k, \boldsymbol{\psi}) = \lambda_k((\boldsymbol{\phi}_k, \boldsymbol{\psi})),$$

for every  $\boldsymbol{\psi} \in W_0^{1,2}(\sigma)^2$ .  $\boldsymbol{\phi}_1, \boldsymbol{\phi}_2, \dots$  is a system which is complete in both  $L^2(\sigma)^2$  and  $W_0^{1,2}(\sigma)^2$ , orthonormal in  $L^2(\sigma)^2$  and orthogonal in  $W_0^{1,2}(\sigma)^2$ .

Since  $\mathbf{f} \in L^2(0, T; L^2(\sigma)^2)$  and  $\mathbf{a} \in W_0^{1,2}(\sigma)^2$ , we have

$$\mathbf{f} = \sum_{k=1}^{\infty} \alpha_k(t) \boldsymbol{\phi}_k, \quad \mathbf{a} = \sum_{k=1}^{\infty} a_k \boldsymbol{\phi}_k,$$

where

$$\sum_{k=1}^{\infty} \int_0^T \alpha_k(t)^2 dt + \sum_{k=1}^{\infty} a_k^2 < \infty.$$

Let  $y_k$  be a solution of the ordinary differential equation

$$y_k'(t) + \lambda_k y_k(t) = \alpha_k(t), \quad (2.110)$$

(which holds for almost every  $t \in \langle 0, T \rangle$ ) with the initial condition

$$y_k(0) = a_k,$$

for  $k = 1, 2, \dots$ . Then there holds

$$y_k(t) = \int_0^t e^{\lambda_k(s-t)} \alpha_k(s) ds + a_k e^{-\lambda_k t},$$

for every  $t \in \langle 0, T \rangle$ . Hence  $y_k \in W^{1,2}(\langle 0, t \rangle)$ . Multiplying (2.110) by  $2y_k'$  and integrating over  $(0, t)$  we get

$$\begin{aligned} 2 \int_0^t y_k'^2(s) ds + \lambda_k y_k^2(t) &= \lambda_k y_k^2(0) + 2 \int_0^t \alpha_k(s) y_k'(s) ds \\ &\leq \lambda_k y_k^2(0) + \int_0^t y_k'^2(s) ds + \int_0^t \alpha_k^2(s) ds, \end{aligned}$$

for  $k = 1, 2, \dots$  and for every  $t \in \langle 0, T \rangle$ , and therefore

$$\int_0^t y_k'^2(s) ds + \lambda_k y_k^2(t) \leq \lambda_k y_k^2(0) + \int_0^t \alpha_k^2(s) ds. \quad (2.111)$$

Thus (2.111) yields

$$\begin{aligned} \sum_{k=1}^{\infty} \int_0^t y_k'^2(s) ds + \sum_{k=1}^{\infty} \lambda_k y_k^2(t) &\leq \sum_{k=1}^{\infty} \int_0^T y_k'^2(s) ds + \sum_{k=1}^{\infty} \lambda_k y_k^2(t) \\ &\leq 2 \sum_{k=1}^{\infty} \lambda_k y_k^2(0) + 2 \sum_{k=1}^{\infty} \int_0^T \alpha_k^2(s) ds \end{aligned}$$

for every  $t \in \langle 0, T \rangle$  and therefore we have

$$\mathbf{v} = \sum_{k=1}^{\infty} y_k(t) \phi_k \in L^\infty(0, T; W_0^{1,2}(\sigma)^2), \quad \mathbf{v}' \in L^2(0, T; L^2(\sigma)^2),$$

and  $\mathbf{v}$ , the solution of (2.108), satisfies the estimate (2.109).

Finally, suppose that  $\mathbf{v}_1$  and  $\mathbf{v}_2$  are solutions of this problem for given data  $\mathbf{f}$  and  $\mathbf{a}$ . Denote  $\mathbf{v}_{12} = \mathbf{v}_1 - \mathbf{v}_2$ . Then

$$((\mathbf{v}'_{12}(t), \boldsymbol{\psi})) + \mathbf{a}(\mathbf{v}_{12}(t), \boldsymbol{\psi}) = 0, \quad (2.112)$$

for every  $\boldsymbol{\psi} \in W_0^{1,2}(\sigma)^2$  and for almost every  $t \in \langle 0, T \rangle$  and

$$\mathbf{v}_{12}(0) = \mathbf{0}.$$

Using  $\boldsymbol{\psi} = \mathbf{v}_{12}(t)$  in (2.112) and integrating over  $\langle 0, T \rangle$ , we obtain

$$\|\mathbf{v}_{12}(T)\|_{L^2(\sigma)^2}^2 + \int_0^T \mathbf{a}(\mathbf{v}_{12}(t), \mathbf{v}_{12}(t)) = 0.$$

Therefore, we get  $\mathbf{v}_{12} = \mathbf{0}$  and consequently  $\mathbf{v}_1 = \mathbf{v}_2$ . This completes the proof. □

## Chapter 3

# Asymptotic Analysis of the Nonsteady Micropolar Fluid Flow in a Thin Undeformed Pipe

In this Chapter, following [6], we propose an asymptotic model for the nonsteady micropolar fluid flow in a thin pipe. Motivated by the various applications where pipes that are either thin or long naturally appear, we introduce a small parameter  $\epsilon$  in the problem (representing the pipe's thickness) and aim to construct the approximate solution. We start from the assumption that the solution of the governing problem has the so-called micropolar Poiseuille form, introduced in Chapter 2. Before further asymptotic analysis, we first need to establish the solvability of the so obtained system endowed with the appropriate initial and boundary conditions. It should be noted that, this has already been done in a more general form in Chapter 2. Then, we employ the idea from [27] where the nonsteady flow of a Newtonian fluid has been studied (see also [25]–[26] for multiple pipe system) and separate the problem by linearity. As a result, we obtain two problems, and call them micropolar heat and micropolar inverse problem. For each problem, we construct the two-scale asymptotic expansion in powers of  $\epsilon$  up to an arbitrary order by simultaneously solving the boundary-value problems for the velocity and microrotation. Since, in the process, the initial conditions are not taken into account, boundary-layer-in-time correctors need to be introduced and corresponding results for their exponential decay proved. We accomplish that by extending the known results from the classical Navier-Stokes theory. Finally, using functional analysis tools, we derive satisfactory error estimates in the appropriate rescaled norms. By doing that, we justify the usage of the formally derived asymptotic model, provide its order of accuracy and determine the range of its applicability. It is important to note that an asymptotic model for the steady flow of a micropolar fluid in a thin three-dimensional pipe has been derived in [29].

The Chapter is organized as follows. In Section 3.1, we describe the governing system of equations, introduce the micropolar Poiseuille form of the solution and separate the problem by linearity. In Section 3.2, we study the micropolar heat problem, existence and uniqueness issues for the regular part of the asymptotic expansion and the boundary–layer–in–time (along with the exponential decay in time). In Section 3.3, we do the same for the micropolar inverse problem, where we additionally deal with the time–dependent pressure appearing in the equations. In Section 3.4, we rigorously justify the proposed model by proving the error estimates in the appropriate norms. Let us note that in Appendix A, we have provided the explicit expressions with numerical illustrations for the zero–order approximation, first and second–order correctors in the case of circular cross–section and external force functions dependent only on time.

### 3.1 Setting of the Problem

Let  $\epsilon$  be a small positive parameter. We consider a thin pipe

$$\Omega_\epsilon = \{x \in \mathbb{R}^3: x_1 \in \mathbb{R}, x' = (x_2, x_3) \in \sigma_\epsilon = \epsilon\sigma\},$$

where  $\sigma \subset \mathbb{R}^2$  is the bounded cross–section. We denote by  $(x_1, x_2, x_3)$  the Cartesian coordinates, where  $x_1$  is the direction coinciding with the longitudinal axis of the pipe.

We consider the initial boundary value problem for the nonsteady flow of a micropolar fluid in a thin straight pipe:

$$\begin{aligned} \frac{\partial \mathbf{u}_\epsilon}{\partial t} - (\nu + \nu_r)\Delta \mathbf{u}_\epsilon + (\mathbf{u}_\epsilon \cdot \nabla)\mathbf{u}_\epsilon + \nabla p_\epsilon &= 2\nu_r \text{rot} \mathbf{w}_\epsilon + \mathbf{f}_\epsilon, \\ \text{div} \mathbf{u}_\epsilon &= 0, \quad x \in \Omega_\epsilon, \\ \frac{\partial \mathbf{w}_\epsilon}{\partial t} - (c_a + c_d)\Delta \mathbf{w}_\epsilon + (\mathbf{u}_\epsilon \cdot \nabla)\mathbf{w}_\epsilon - (c_0 + c_d - c_a)\nabla \text{div} \mathbf{w}_\epsilon + 4\nu_r \mathbf{w}_\epsilon &= 2\nu_r \text{rot} \mathbf{u}_\epsilon + \mathbf{g}_\epsilon, \end{aligned} \tag{3.1}$$

endowed with the initial and boundary conditions

$$\begin{aligned} \mathbf{u}_\epsilon|_{\partial\Omega_\epsilon} &= \mathbf{0}, \quad \mathbf{w}_\epsilon|_{\partial\Omega_\epsilon} = \mathbf{0}, \\ \mathbf{u}_\epsilon(x, 0) &= \mathbf{a}_\epsilon(x), \quad \mathbf{w}_\epsilon(x, 0) = \mathbf{b}_\epsilon(x), \end{aligned} \tag{3.2}$$

and the flux condition with the given flow rate

$$\int_{\sigma_\epsilon} u_\epsilon^1(x_1, x', t) dx' = F(t). \tag{3.3}$$

Here  $\mathbf{u}_\epsilon(x_1, x', t) = (u_\epsilon^1(x_1, x', t), u_\epsilon^2(x_1, x', t), u_\epsilon^3(x_1, x', t))$  represents the velocity field,  $\mathbf{w}_\epsilon(x_1, x', t) = (w_\epsilon^1(x_1, x', t), w_\epsilon^2(x_1, x', t), w_\epsilon^3(x_1, x', t))$  stands for the microrotation field,

while  $p_\epsilon(x_1, x', t)$  is the pressure. The positive constants in the system are the Newtonian viscosity  $\nu$ , the microrotation viscosity  $\nu_r$ , while  $c_0, c_a$  and  $c_d$  are coefficients of angular viscosities.

To simplify the notation, we introduce:  $\mu = \nu + \nu_r$ ,  $\alpha = c_a + c_d$ ,  $\beta = c_0 + c_d - c_a$  and  $a = 2\nu_r$ . The external sources of linear and angular momentum are given by the functions  $\mathbf{f}_\epsilon(x_1, x', t) = (f_\epsilon^1(x_1, x', t), f_\epsilon^2(x_1, x', t), f_\epsilon^3(x_1, x', t))$  and  $\mathbf{g}_\epsilon(x_1, x', t) = (g_\epsilon^1(x_1, x', t), g_\epsilon^2(x_1, x', t), g_\epsilon^3(x_1, x', t))$ , respectively.

We now assume that the solution of (3.1)–(3.3) has the micropolar Poiseuille form:

$$\mathbf{u}_\epsilon(x, t) = (v_\epsilon(x', t), 0, 0), \quad \mathbf{w}_\epsilon(x, t) = (0, w_\epsilon^2(x', t), w_\epsilon^3(x', t)), \quad p_\epsilon(x, t) = -q(t)x_1 + p_0(t), \quad (3.4)$$

where  $p_0(t)$  is an arbitrary function in  $t$ . Furthermore, we assume that the initial data  $\mathbf{a}_\epsilon(x') = (a_\epsilon(x'), 0, 0)$ ,  $\mathbf{b}_\epsilon(x') = (0, b_\epsilon^2(x'), b_\epsilon^3(x'))$  are independent of the longitudinal variable  $x_1 \in \mathbb{R}$  and the time variable  $t > 0$ , while the external force functions  $\mathbf{f}_\epsilon(x', t) = (f_\epsilon(x', t), 0, 0)$ ,  $\mathbf{g}_\epsilon(x', t) = (0, g_\epsilon^2(x', t), g_\epsilon^3(x', t))$  are independent of  $x_1$ .

Let there also hold the necessary compatibility condition

$$\int_{\sigma_\epsilon} a_\epsilon(x') dx' = F(0). \quad (3.5)$$

Plugging the micropolar Poiseuille solution (3.4) into the governing system of equations (3.1)–(3.3), we get the following problem posed on the cross-section  $\sigma_\epsilon$ :

$$\begin{aligned} \frac{\partial v_\epsilon}{\partial t} - \mu \Delta_{x'} v_\epsilon - q(t) &= a \left( \frac{\partial w_\epsilon^3}{\partial x_2} - \frac{\partial w_\epsilon^2}{\partial x_3} \right) + f_\epsilon, \\ \frac{\partial w_\epsilon^2}{\partial t} - \alpha \Delta_{x'} w_\epsilon^2 - \beta \frac{\partial}{\partial x_2} \left( \frac{\partial w_\epsilon^2}{\partial x_2} + \frac{\partial w_\epsilon^3}{\partial x_3} \right) + 2aw_\epsilon^2 &= a \frac{\partial v_\epsilon}{\partial x_3} + g_\epsilon^2, \\ \frac{\partial w_\epsilon^3}{\partial t} - \alpha \Delta_{x'} w_\epsilon^3 - \beta \frac{\partial}{\partial x_3} \left( \frac{\partial w_\epsilon^2}{\partial x_2} + \frac{\partial w_\epsilon^3}{\partial x_3} \right) + 2aw_\epsilon^3 &= -a \frac{\partial v_\epsilon}{\partial x_2} + g_\epsilon^3, \end{aligned} \quad (3.6)$$

where we introduced the Laplace operator with respect to the cross-section variables:

$$\Delta_{x'} v = \frac{\partial^2 v}{\partial x_2^2} + \frac{\partial^2 v}{\partial x_3^2}.$$

The system is completed with the following initial and boundary conditions

$$\begin{aligned} v_\epsilon|_{\partial\sigma_\epsilon} &= 0, \quad w_\epsilon^2|_{\partial\sigma_\epsilon} = 0, \quad w_\epsilon^3|_{\partial\sigma_\epsilon} = 0, \\ v_\epsilon(x', 0) &= a_\epsilon(x'), \quad w_\epsilon^2(x', 0) = b_\epsilon^2(x'), \quad w_\epsilon^3(x', 0) = b_\epsilon^3(x'), \end{aligned} \quad (3.7)$$

and the flux condition

$$\int_{\sigma_\epsilon} v_\epsilon(x', t) dx' = F(t). \quad (3.8)$$

In the sequel, we assume that  $f_\epsilon, g_\epsilon^2, g_\epsilon^3 \in L^2(0, \infty; L^2(\sigma_\epsilon))$ ,  $a_\epsilon, b_\epsilon^2, b_\epsilon^3 \in W_0^{1,2}(\sigma_\epsilon)$  and  $F \in W^{1,2}((0, \infty))$ .



The weak solution of problem (3.6)–(3.8) is a triple  $(v_\epsilon, \hat{\mathbf{w}}_\epsilon, q) \in (L^2(0, \infty; W_0^{1,2}(\sigma_\epsilon)) \cap W^{1,2}(0, \infty; L^2(\sigma_\epsilon))) \times (L^2(0, \infty; W_0^{1,2}(\sigma_\epsilon)^2) \cap W^{1,2}(0, \infty; L^2(\sigma_\epsilon)^2)) \times L^2(\langle 0, \infty \rangle)$  satisfying for all  $t \in [0, \infty)$  the following relations:

$$\begin{aligned}
 & \int_0^t \int_{\sigma_\epsilon} \frac{\partial v_\epsilon}{\partial \tau} \varphi \, dx' d\tau + \mu \int_0^t \int_{\sigma_\epsilon} \nabla_{x'} v_\epsilon \cdot \nabla_{x'} \varphi \, dx' d\tau = \int_0^t q(\tau) \int_{\sigma_\epsilon} \varphi \, dx' d\tau \\
 & + a \int_0^t \int_{\sigma_\epsilon} \left( \frac{\partial w_\epsilon^3}{\partial x_2} - \frac{\partial w_\epsilon^2}{\partial x_3} \right) \varphi \, dx' d\tau + \int_0^t \int_{\sigma_\epsilon} f_\epsilon \varphi \, dx' d\tau, \quad \forall \varphi \in L^2(0, \infty; W_0^{1,2}(\sigma_\epsilon)), \\
 & \int_0^t \int_{\sigma_\epsilon} \frac{\partial \hat{\mathbf{w}}_\epsilon}{\partial \tau} \cdot \boldsymbol{\psi} \, dx' d\tau + \alpha \int_0^t \int_{\sigma_\epsilon} \nabla_{x'} \hat{\mathbf{w}}_\epsilon \cdot \nabla_{x'} \boldsymbol{\psi} \, dx' d\tau \\
 & + \beta \int_0^t \int_{\sigma_\epsilon} \operatorname{div} \hat{\mathbf{w}}_\epsilon \operatorname{div} \boldsymbol{\psi} \, dx' d\tau + 2a \int_0^t \int_{\sigma_\epsilon} \hat{\mathbf{w}}_\epsilon \cdot \boldsymbol{\psi} \, dx' d\tau \\
 & = a \int_0^t \int_{\sigma_\epsilon} \nabla^\perp v_\epsilon \cdot \boldsymbol{\psi} \, dx' d\tau + \int_0^t \int_{\sigma_\epsilon} \hat{\mathbf{g}}_\epsilon \cdot \boldsymbol{\psi} \, dx' d\tau, \quad \forall \boldsymbol{\psi} \in L^2(0, \infty; W_0^{1,2}(\sigma_\epsilon)^2).
 \end{aligned} \tag{3.9}$$

Here we introduced the operators  $\nabla_{x'} v = \left( \frac{\partial v}{\partial x_2}, \frac{\partial v}{\partial x_3} \right)$  and  $\nabla^\perp v = \left( \frac{\partial v}{\partial x_3}, -\frac{\partial v}{\partial x_2} \right)$  and denote  $\hat{\mathbf{w}}_\epsilon = (w_\epsilon^2, w_\epsilon^3)$ ,  $\hat{\mathbf{g}}_\epsilon = (g_\epsilon^2, g_\epsilon^3)$  and  $\boldsymbol{\psi} = (\psi_2, \psi_3)$ . The initial conditions  $v_\epsilon(x', 0) = a_\epsilon(x')$ ,  $w_\epsilon^2(x', 0) = b_\epsilon^2(x')$ ,  $w_\epsilon^3(x', 0) = b_\epsilon^3(x')$  are to be satisfied along with the flux condition

$$\int_{\sigma_\epsilon} v_\epsilon(x', t) dx' = F(t).$$

The result on the existence and uniqueness of the weak solution to the problem (3.6)–(3.8) can be formulated as follows:

**Theorem 3.1** (Existence and uniqueness – micropolar Poiseuille solution).

*There exists an unique weak solution  $(v_\epsilon, w_\epsilon^2, w_\epsilon^3, q) \in (L^2(0, \infty; W_0^{1,2}(\sigma_\epsilon)^3) \cap W^{1,2}(0, \infty; L^2(\sigma_\epsilon)^3)) \times L^2(\langle 0, \infty \rangle)$  of the problem (3.6)–(3.8).*

The detailed proof of Theorem 3.1 in a more general setting can be found in Chapter 2.

Following [27], we represent the solution  $(v_\epsilon(x', t), \hat{\mathbf{w}}_\epsilon(x', t))$  in the following way:

$$v_\epsilon(x', t) = V_\epsilon^1(x', t) + V_\epsilon^2(x', t), \quad \hat{\mathbf{w}}_\epsilon(x', t) = \mathbf{W}_\epsilon^a(x', t) + \mathbf{W}_\epsilon^b(x', t),$$

where  $(V_\epsilon^1(x', t), \mathbf{W}_\epsilon^a(x', t)) = (V_\epsilon^1(x', t), W_\epsilon^{2,1}(x', t), W_\epsilon^{3,1}(x', t))$  is the solution of the initial boundary value problem for the micropolar heat problem on the cross-section  $\sigma_\epsilon$ :

$$\begin{aligned}
 & \frac{\partial V_\epsilon^1}{\partial t} - \mu \Delta_{x'} V_\epsilon^1 = a \left( \frac{\partial W_\epsilon^{3,1}}{\partial x_2} - \frac{\partial W_\epsilon^{2,1}}{\partial x_3} \right) + f_\epsilon, \\
 & \frac{\partial W_\epsilon^{2,1}}{\partial t} - \alpha \Delta_{x'} W_\epsilon^{2,1} - \beta \frac{\partial}{\partial x_2} \left( \frac{\partial W_\epsilon^{2,1}}{\partial x_2} + \frac{\partial W_\epsilon^{3,1}}{\partial x_3} \right) + 2a W_\epsilon^{2,1} = a \frac{\partial V_\epsilon^1}{\partial x_3} + g_\epsilon^2, \\
 & \frac{\partial W_\epsilon^{3,1}}{\partial t} - \alpha \Delta_{x'} W_\epsilon^{3,1} - \beta \frac{\partial}{\partial x_3} \left( \frac{\partial W_\epsilon^{2,1}}{\partial x_2} + \frac{\partial W_\epsilon^{3,1}}{\partial x_3} \right) + 2a W_\epsilon^{3,1} = -a \frac{\partial V_\epsilon^1}{\partial x_2} + g_\epsilon^3, \\
 & V_\epsilon^1 \Big|_{\partial \sigma_\epsilon} = 0, \quad W_\epsilon^{2,1} \Big|_{\partial \sigma_\epsilon} = 0, \quad W_\epsilon^{3,1} \Big|_{\partial \sigma_\epsilon} = 0, \\
 & V_\epsilon^1(x', 0) = a_\epsilon(x'), \quad W_\epsilon^{2,1}(x', 0) = b_\epsilon^2(x'), \quad W_\epsilon^{3,1}(x', 0) = b_\epsilon^3(x'),
 \end{aligned} \tag{3.10}$$

whereas  $(V_\epsilon^2(x', t), \mathbf{W}_\epsilon^b(x', t), q(t)) = (V_\epsilon^2(x', t), W_\epsilon^{2,2}(x', t), W_\epsilon^{3,2}(x', t), q(t))$  is the solution of the micropolar inverse problem with the homogeneous initial condition and given flux rate posed on  $\sigma_\epsilon$ :

$$\begin{aligned}
 \frac{\partial V_\epsilon^2}{\partial t} - \mu \Delta_{x'} V_\epsilon^2 &= a \left( \frac{\partial W_\epsilon^{3,2}}{\partial x_2} - \frac{\partial W_\epsilon^{2,2}}{\partial x_3} \right) + q(t), \\
 \frac{\partial W_\epsilon^{2,2}}{\partial t} - \alpha \Delta_{x'} W_\epsilon^{2,2} - \beta \frac{\partial}{\partial x_2} \left( \frac{\partial W_\epsilon^{2,2}}{\partial x_2} + \frac{\partial W_\epsilon^{3,2}}{\partial x_3} \right) + 2a W_\epsilon^{2,2} &= a \frac{\partial V_\epsilon^2}{\partial x_3}, \\
 \frac{\partial W_\epsilon^{3,2}}{\partial t} - \alpha \Delta_{x'} W_\epsilon^{3,2} - \beta \frac{\partial}{\partial x_3} \left( \frac{\partial W_\epsilon^{2,2}}{\partial x_2} + \frac{\partial W_\epsilon^{3,2}}{\partial x_3} \right) + 2a W_\epsilon^{3,2} &= -a \frac{\partial V_\epsilon^2}{\partial x_2}, \\
 V_\epsilon^2 \Big|_{\partial \sigma_\epsilon} &= 0, \quad W_\epsilon^{2,2} \Big|_{\partial \sigma_\epsilon} = 0, \quad W_\epsilon^{3,2} \Big|_{\partial \sigma_\epsilon} = 0, \\
 V_\epsilon^2(x', 0) &= 0, \quad W_\epsilon^{2,2}(x', 0) = 0, \quad W_\epsilon^{3,2}(x', 0) = 0, \\
 \int_{\sigma_\epsilon} V_\epsilon^2(x', t) dx' &= H(t).
 \end{aligned} \tag{3.11}$$

Here we denote

$$H(t) = F(t) - \int_{\sigma_\epsilon} V_\epsilon^1(x', t) dx'. \tag{3.12}$$

Note that from (3.5) it follows

$$H(0) = 0. \tag{3.13}$$

In view of the problem to be considered, we assume the following scaling of the given functions with respect to the small parameter  $\epsilon$ :

$$a_\epsilon, b_\epsilon^2, b_\epsilon^3 \sim \epsilon^2, \quad f_\epsilon \sim 1, \quad g_\epsilon^2 \sim 1, \quad g_\epsilon^3 \sim 1, \quad F \sim \epsilon^4.$$

Let  $J \in \mathbb{N}$ . We assume that  $\tilde{f}_j, \tilde{g}_j^2, \tilde{g}_j^3 \in L^2(0, \infty; L^2(\sigma))$ ,  $\tilde{a}_j, \tilde{b}_j^2, \tilde{b}_j^3 \in W_0^{1,2}(\sigma)$ ,  $F^j \in W^{[\frac{J-j}{2}+1], 2}(\langle 0, \infty \rangle)$  are independent of  $\epsilon$  functions such that  $\tilde{f}_j, \tilde{g}_j^2, \tilde{g}_j^3$  have derivatives in time up to the order  $[\frac{J-j}{2} + 1]$  belonging to  $L^2(0, \infty; L^2(\sigma))$  for all  $j = 0, 1, \dots, N$ , where  $[\cdot]$  stands for the integer part of the number.

In the following, we expand:

$$\begin{aligned}
 \tilde{a}(y') &= \sum_{j=0}^J \epsilon^{j+2} \tilde{a}_j(y'), \quad \tilde{b}^2(y') = \sum_{j=0}^J \epsilon^{j+2} \tilde{b}_j^2(y'), \quad \tilde{b}^3(y') = \sum_{j=0}^J \epsilon^{j+2} \tilde{b}_j^3(y'), \\
 \tilde{f}(y', t) &= \sum_{j=0}^J \epsilon^j \tilde{f}_j(y', t), \quad \tilde{g}^2(y', t) = \sum_{j=0}^J \epsilon^j \tilde{g}_j^2(y', t), \quad \tilde{g}^3(y', t) = \sum_{j=0}^J \epsilon^j \tilde{g}_j^3(y', t), \\
 F(t) &= \sum_{j=0}^J \epsilon^{j+4} F^j(t),
 \end{aligned} \tag{3.14}$$

and consider the problem (3.6)–(3.8) with

$$\begin{aligned} a_\epsilon(x) &= \tilde{a}\left(\frac{x'}{\epsilon}\right), \quad b_\epsilon^2(x) = \tilde{b}^2\left(\frac{x'}{\epsilon}\right), \quad b_\epsilon^3(x) = \tilde{b}^3\left(\frac{x'}{\epsilon}\right), \\ f_\epsilon(x, t) &= \tilde{f}\left(\frac{x'}{\epsilon}, t\right), \quad g_\epsilon^2(x, t) = \tilde{g}^2\left(\frac{x'}{\epsilon}, t\right), \quad g_\epsilon^3(x, t) = \tilde{g}^3\left(\frac{x'}{\epsilon}, t\right). \end{aligned}$$

## 3.2 Micropolar Heat Problem (MHP)

To do our analysis, we first need to rescale the domain, that is, to write the governing problem on  $\sigma$  instead of  $\sigma_\epsilon$ . We thus introduce the change of variables  $y' = \frac{x'}{\epsilon}$  and obtain the following system of micropolar heat equations posed on the  $\epsilon$ -independent domain  $\sigma$ :

$$\begin{aligned} \frac{\partial \tilde{V}^1(y', t)}{\partial t} - \frac{\mu}{\epsilon^2} \Delta_{y'} \tilde{V}^1(y', t) &= \frac{a}{\epsilon} \left( \frac{\partial \tilde{W}^{3,1}(y', t)}{\partial y_2} - \frac{\partial \tilde{W}^{2,1}(y', t)}{\partial y_3} \right) + \tilde{f}(y', t), \\ \frac{\partial \tilde{W}^{2,1}(y', t)}{\partial t} - \frac{\alpha}{\epsilon^2} \Delta_{y'} \tilde{W}^{2,1}(y', t) - \frac{\beta}{\epsilon^2} \frac{\partial}{\partial y_2} \left( \frac{\partial \tilde{W}^{2,1}(y', t)}{\partial y_2} + \frac{\partial \tilde{W}^{3,1}(y', t)}{\partial y_3} \right) &+ 2a \tilde{W}^{2,1}(y', t) \\ &= \frac{a}{\epsilon} \frac{\partial \tilde{V}^1(y', t)}{\partial y_3} + \tilde{g}^2(y', t), \\ \frac{\partial \tilde{W}^{3,1}(y', t)}{\partial t} - \frac{\alpha}{\epsilon^2} \Delta_{y'} \tilde{W}^{3,1}(y', t) - \frac{\beta}{\epsilon^2} \frac{\partial}{\partial y_3} \left( \frac{\partial \tilde{W}^{2,1}(y', t)}{\partial y_2} + \frac{\partial \tilde{W}^{3,1}(y', t)}{\partial y_3} \right) &+ 2a \tilde{W}^{3,1}(y', t) \\ &= -\frac{a}{\epsilon} \frac{\partial \tilde{V}^1(y', t)}{\partial y_2} + \tilde{g}^3(y', t), \end{aligned} \tag{3.15}$$

where  $\tilde{V}^1(y', t) = V_\epsilon^1(\epsilon y', t)$ ,  $\tilde{W}^{2,1}(y', t) = W_\epsilon^{2,1}(\epsilon y', t)$ ,  $\tilde{W}^{3,1}(y', t) = W_\epsilon^{3,1}(\epsilon y', t)$ . The following boundary and initial conditions are satisfied:

$$\begin{aligned} \tilde{V}^1(y', t) \Big|_{\partial\sigma} &= 0, \quad \tilde{W}^{2,1}(y', t) \Big|_{\partial\sigma} = 0, \quad \tilde{W}^{3,1}(y', t) \Big|_{\partial\sigma} = 0, \\ \tilde{V}^1(y', 0) &= \tilde{a}(y'), \quad \tilde{W}^{2,1}(y', 0) = \tilde{b}^2(y'), \quad \tilde{W}^{3,1}(y', 0) = \tilde{b}^3(y'). \end{aligned}$$

We rewrite problem (3.15) in the following way:

$$\begin{aligned} -\mu \Delta_{y'} \tilde{V}^1(y', t) &= a\epsilon \left( \frac{\partial \tilde{W}^{3,1}(y', t)}{\partial y_2} - \frac{\partial \tilde{W}^{2,1}(y', t)}{\partial y_3} \right) + \epsilon^2 \tilde{f}(y', t) - \epsilon^2 \frac{\partial \tilde{V}^1(y', t)}{\partial t}, \\ -\alpha \Delta_{y'} \tilde{W}^{2,1}(y', t) - \beta \frac{\partial}{\partial y_2} \left( \frac{\partial \tilde{W}^{2,1}(y', t)}{\partial y_2} + \frac{\partial \tilde{W}^{3,1}(y', t)}{\partial y_3} \right) &= a\epsilon \frac{\partial \tilde{V}^1(y', t)}{\partial y_3} \\ &+ \epsilon^2 \tilde{g}^2(y', t) - \epsilon^2 \frac{\partial \tilde{W}^{2,1}(y', t)}{\partial t} - 2a\epsilon^2 \tilde{W}^{2,1}(y', t), \\ -\alpha \Delta_{y'} \tilde{W}^{3,1}(y', t) - \beta \frac{\partial}{\partial y_3} \left( \frac{\partial \tilde{W}^{2,1}(y', t)}{\partial y_2} + \frac{\partial \tilde{W}^{3,1}(y', t)}{\partial y_3} \right) &= -a\epsilon \frac{\partial \tilde{V}^1(y', t)}{\partial y_2} \\ &+ \epsilon^2 \tilde{g}^3(y', t) - \epsilon^2 \frac{\partial \tilde{W}^{3,1}(y', t)}{\partial t} - 2a\epsilon^2 \tilde{W}^{3,1}(y', t). \end{aligned} \tag{3.16}$$

We construct the formal asymptotic expansion of the solution  $(\tilde{V}_{\epsilon,[J]}^1(y', t), \tilde{W}_{\epsilon,[J]}^{2,1}(y', t), \tilde{W}_{\epsilon,[J]}^{3,1}(y', t))$  up to the order  $J \in \mathbb{N}$  in powers  $\epsilon$  as:

$$\begin{aligned} \tilde{V}_{\epsilon,[J]}^1(y', t) &= \sum_{j=0}^J \epsilon^{j+2} \tilde{V}_j^1(y', t), \\ \tilde{W}_{\epsilon,[J]}^{2,1}(y', t) &= \sum_{j=0}^J \epsilon^{j+2} \tilde{W}_j^{2,1}(y', t), \quad \tilde{W}_{\epsilon,[J]}^{3,1}(y', t) = \sum_{j=0}^J \epsilon^{j+2} \tilde{W}_j^{3,1}(y', t). \end{aligned} \quad (3.17)$$

Due to the appearance of the boundary layers in time, we are going to fix our approximation by introducing

$$\begin{aligned} \mathcal{V}_{\epsilon,[J]}^1(y', \tau) &= \sum_{j=0}^J \epsilon^{j+2} \mathcal{V}_j^1(y', \tau), \\ \mathcal{W}_{\epsilon,[J]}^{2,1}(y', \tau) &= \sum_{j=0}^J \epsilon^{j+2} \mathcal{W}_j^{2,1}(y', \tau), \quad \mathcal{W}_{\epsilon,[J]}^{3,1}(y', \tau) = \sum_{j=0}^J \epsilon^{j+2} \mathcal{W}_j^{3,1}(y', \tau), \quad \tau = \frac{t}{\epsilon^2}. \end{aligned} \quad (3.18)$$

### 3.2.1 Regular Part of the Asymptotic Expansion

Plugging the asymptotic expansions (3.17) into the micropolar heat problem (3.16), we obtain the recursive sequence of the problems for  $(\tilde{V}_j^1(y', t), \tilde{W}_j^{2,1}(y', t), \tilde{W}_j^{3,1}(y', t))$  ( $j = 0, 1, \dots, J$ ).

The equations on  $\sigma$  for the zero-order approximation  $(\tilde{V}_0^1(y', t), \tilde{W}_0^{2,1}(y', t), \tilde{W}_0^{3,1}(y', t))$  read:

$$\begin{aligned} -\mu \Delta_{y'} \tilde{V}_0^1(y', t) &= \tilde{f}_0(y', t), \\ -\alpha \Delta_{y'} \tilde{W}_0^{2,1}(y', t) - \beta \frac{\partial}{\partial y_2} \left( \frac{\partial \tilde{W}_0^{2,1}(y', t)}{\partial y_2} + \frac{\partial \tilde{W}_0^{3,1}(y', t)}{\partial y_3} \right) &= \tilde{g}_0^2(y', t), \\ -\alpha \Delta_{y'} \tilde{W}_0^{3,1}(y', t) - \beta \frac{\partial}{\partial y_3} \left( \frac{\partial \tilde{W}_0^{2,1}(y', t)}{\partial y_1} + \frac{\partial \tilde{W}_0^{3,1}(y', t)}{\partial y_2} \right) &= \tilde{g}_0^3(y', t), \\ \tilde{V}_0^1(y', t) \Big|_{\partial \sigma} &= 0, \quad \tilde{W}_0^{2,1}(y', t) \Big|_{\partial \sigma} = 0, \quad \tilde{W}_0^{3,1}(y', t) \Big|_{\partial \sigma} = 0. \end{aligned} \quad (3.19)$$

The first-order corrector  $(\tilde{V}_1^1(y', t), \tilde{W}_1^{2,1}(y', t), \tilde{W}_1^{3,1}(y', t))$  satisfies the following:

$$\begin{aligned} -\mu \Delta_{y'} \tilde{V}_1^1(y', t) &= a \left( \frac{\partial \tilde{W}_0^{3,1}(y', t)}{\partial y_2} - \frac{\partial \tilde{W}_0^{2,1}(y', t)}{\partial y_3} \right) + \tilde{f}_1(y', t), \\ -\alpha \Delta_{y'} \tilde{W}_1^{2,1}(y', t) - \beta \frac{\partial}{\partial y_2} \left( \frac{\partial \tilde{W}_1^{2,1}(y', t)}{\partial y_2} + \frac{\partial \tilde{W}_1^{3,1}(y', t)}{\partial y_3} \right) &= a \frac{\partial \tilde{V}_0^1(y', t)}{\partial y_3} + \tilde{g}_1^2(y', t), \\ -\alpha \Delta_{y'} \tilde{W}_1^{3,1}(y', t) - \beta \frac{\partial}{\partial y_3} \left( \frac{\partial \tilde{W}_1^{2,1}(y', t)}{\partial y_2} + \frac{\partial \tilde{W}_1^{3,1}(y', t)}{\partial y_3} \right) &= -a \frac{\partial \tilde{V}_0^1(y', t)}{\partial y_2} + \tilde{g}_1^3(y', t), \\ \tilde{V}_1^1(y', t) \Big|_{\partial \sigma} &= 0, \quad \tilde{W}_1^{2,1}(y', t) \Big|_{\partial \sigma} = 0, \quad \tilde{W}_1^{3,1}(y', t) \Big|_{\partial \sigma} = 0. \end{aligned} \quad (3.20)$$

For the higher-order correctors  $(\tilde{V}_j^1(y', t), \tilde{W}_j^{2,1}(y', t), \tilde{W}_j^{3,1}(y', t))$  ( $j = 2, \dots, J$ ) we obtain:

$$\begin{aligned}
 -\mu \Delta_{y'} \tilde{V}_j^1(y', t) &= a \left( \frac{\partial \tilde{W}_{j-1}^{3,1}(y', t)}{\partial y_2} - \frac{\partial \tilde{W}_{j-1}^{2,1}(y', t)}{\partial y_3} \right) + \tilde{f}_j(y', t) - \frac{\partial \tilde{V}_{j-2}^1(y', t)}{\partial t}, \\
 &\quad - \alpha \Delta_{y'} \tilde{W}_j^{2,1}(y', t) - \beta \frac{\partial}{\partial y_2} \left( \frac{\partial \tilde{W}_j^{2,1}(y', t)}{\partial y_2} + \frac{\partial \tilde{W}_j^{3,1}(y', t)}{\partial y_3} \right) \\
 &= a \frac{\partial \tilde{V}_{j-1}^1(y', t)}{\partial y_3} + \tilde{g}_j^2(y', t) - \frac{\partial \tilde{W}_{j-2}^{2,1}(y', t)}{\partial t} - 2a \tilde{W}_{j-2}^{2,1}(y', t), \\
 &\quad - \alpha \Delta_{y'} \tilde{W}_j^{3,1}(y', t) - \beta \frac{\partial}{\partial y_3} \left( \frac{\partial \tilde{W}_j^{2,1}(y', t)}{\partial y_2} + \frac{\partial \tilde{W}_j^{3,1}(y', t)}{\partial y_3} \right) \\
 &= -a \frac{\partial \tilde{V}_{j-1}^1(y', t)}{\partial y_2} + \tilde{g}_j^3(y', t) - \frac{\partial \tilde{W}_{j-2}^{3,1}(y', t)}{\partial t} - 2a \tilde{W}_{j-2}^{3,1}(y', t), \\
 \tilde{V}_j^1(y', t) \Big|_{\partial \sigma} &= 0, \quad \tilde{W}_j^{2,1}(y', t) \Big|_{\partial \sigma} = 0, \quad \tilde{W}_j^{3,1}(y', t) \Big|_{\partial \sigma} = 0. \tag{3.21}
 \end{aligned}$$

Notice that, at this stage, the initial conditions have been ignored.

We observe that the problems (3.19)–(3.21) are, in fact, decoupled in the sense that we can consider the problem for the velocity  $\tilde{V}_j^1(y', t)$  and microrotation  $(\tilde{W}_j^{2,1}(y', t), \tilde{W}_j^{3,1}(y', t))$  ( $j = 0, 1, \dots, J$ ) separately. This is because the right hand sides of the equations are known either as given in advance external force functions  $\tilde{f}_0(y', t), \dots, \tilde{f}_J(y', t), g_0^2(y', t), \dots, g_J^2(y', t), g_0^3(y', t), \dots, g_J^3(y', t)$  or the velocity and microrotation components deduced in the previous steps. This means that, in fact, we have standard Poisson equations for the velocity zero-order approximation, first and higher-order correctors  $\tilde{V}_j^1(y', t)$  ( $j = 0, 1, \dots, J$ ), where the existence and uniqueness of the solutions follows from the well-known results (see [13], [18]).

On the other hand, the equations for the microrotation zero-order approximation, first and higher order correctors are linear second order PDEs of a more complex structure.

The following theorem is a direct consequence of [22, Chapter II, Section 1.2, Lemma 1.2.1].

**Theorem 3.2** (Existence and uniqueness – MHP microrotation regular part).

Let  $\mathbf{h}_j \in L^2(0, \infty; L^2(\sigma)^2)$  ( $j = 0, 1, \dots, J$ ). Then there exists a unique weak solution  $\tilde{\mathbf{W}}_j^a = (\tilde{W}_j^{2,1}, \tilde{W}_j^{3,1}) \in L^2(0, \infty; W_0^{1,2}(\sigma)^2)$  of the problem

$$\begin{aligned}
 -\alpha \Delta_{y'} \tilde{\mathbf{W}}_j^a(y', t) - \beta \nabla_{y'} (\operatorname{div}_{y'} \tilde{\mathbf{W}}_j^a(y', t)) &= \mathbf{h}_j(y', t), \\
 \tilde{\mathbf{W}}_j^a(y', t) \Big|_{\partial \sigma} &= 0,
 \end{aligned}$$

satisfying for all  $t \in [0, \infty)$  the integral identity:

$$\begin{aligned}
 \alpha \int_0^t \int_{\sigma} \nabla_{y'} \tilde{\mathbf{W}}_j^a \cdot \nabla_{y'} \boldsymbol{\eta} \, dy' d\tau + \beta \int_0^t \int_{\sigma} \operatorname{div} \tilde{\mathbf{W}}_j^a \operatorname{div} \boldsymbol{\eta} \, dy' d\tau \\
 = \int_0^t \int_{\sigma} \mathbf{h}_j \cdot \boldsymbol{\eta} \, dy' d\tau, \quad \forall \boldsymbol{\eta} \in L^2(0, \infty; W_0^{1,2}(\sigma)^2).
 \end{aligned}$$

Moreover, there holds the estimate

$$\|\tilde{\mathbf{W}}_j^a\|_{L^2(0,\infty;W^{1,2}(\sigma)^2)} \leq c\|\mathbf{h}_j\|_{L^2(0,\infty;L^2(\sigma)^2)}.$$

**Remark 3.3.** The explicit formulae for the zero-order approximation, first and second-order correctors  $(\tilde{V}_1^j(y', t), \tilde{W}_{2,1}^j(y', t), \tilde{W}_{3,1}^j(y', t))$ ,  $j = 0, 1, 2$  can be obtained if the cross section  $\sigma$  is assumed to be circular and the external force functions  $\tilde{f}, \tilde{g}_2, \tilde{g}_3$  are supposed to depend only on the time variable  $t$  (see Appendix A).

### 3.2.2 Boundary Layer in Time

In the case of vanishing initial data  $(\tilde{a}(y'), \tilde{b}^2(y'), \tilde{b}^3(y')) \equiv (0, 0, 0)$  and external force functions  $\tilde{f}_j, \tilde{g}_j^2, \tilde{g}_j^3$  being equal to zero in a neighborhood of the point  $t = 0$ , the solutions  $(\tilde{V}_j^1(y', t), \tilde{W}_j^{2,1}(y', t), \tilde{W}_j^{3,1}(y', t))$  of problems (3.19)–(3.21) satisfy the initial conditions  $(\tilde{V}_j^1(y', 0), \tilde{W}_j^{2,1}(y', 0), \tilde{W}_j^{3,1}(y', 0)) \equiv (0, 0, 0)$ . However, the initial conditions are generally not met by the asymptotic expansions (3.17). We thus have to construct boundary-layer correctors near  $t = 0$  to fix our approximation.

Making the change of variable  $\tau = \frac{t}{\epsilon^2}$  in (3.15) and putting  $(\tilde{f}(y', t), \tilde{g}^2(y', t), \tilde{g}^3(y', t)) \equiv (0, 0, 0)$ , we get the following system on the cross-section  $\sigma$ :

$$\begin{aligned} \frac{1}{\epsilon^2} \frac{\partial \mathcal{V}^1(y', \tau)}{\partial \tau} - \frac{\mu}{\epsilon^2} \Delta_{y'} \mathcal{V}^1(y', \tau) &= \frac{a}{\epsilon} \left( \frac{\partial \mathcal{W}^{3,1}(y', \tau)}{\partial y_2} - \frac{\partial \mathcal{W}^{2,1}(y', \tau)}{\partial y_3} \right), \\ \frac{1}{\epsilon^2} \frac{\partial \mathcal{W}^{2,1}(y', \tau)}{\partial \tau} - \frac{\alpha}{\epsilon^2} \Delta_{y'} \mathcal{W}^{2,1}(y', \tau) - \frac{\beta}{\epsilon^2} \frac{\partial}{\partial y_2} \left( \frac{\partial \mathcal{W}^{2,1}(y', \tau)}{\partial y_2} + \frac{\partial \mathcal{W}^{3,1}(y', \tau)}{\partial y_3} \right) \\ &\quad + 2a \mathcal{W}^{2,1}(y', \tau) = \frac{a}{\epsilon} \frac{\partial \mathcal{V}^1(y', \tau)}{\partial y_3}, \\ \frac{1}{\epsilon^2} \frac{\partial \mathcal{W}^{3,1}(y', \tau)}{\partial \tau} - \frac{\alpha}{\epsilon^2} \Delta_{y'} \mathcal{W}^{3,1}(y', \tau) - \frac{\beta}{\epsilon^2} \frac{\partial}{\partial y_3} \left( \frac{\partial \mathcal{W}^{2,1}(y', \tau)}{\partial y_1} + \frac{\partial \mathcal{W}^{3,1}(y', \tau)}{\partial y_3} \right) \\ &\quad + 2a \mathcal{W}^{3,1}(y', \tau) = -\frac{a}{\epsilon} \frac{\partial \mathcal{V}_1(y', \tau)}{\partial y_2}, \\ \mathcal{V}^1(y', \tau) \Big|_{\partial \sigma} &= 0, \quad \mathcal{W}^{2,1}(y', \tau) \Big|_{\partial \sigma} = 0, \quad \mathcal{W}^{3,1}(y', \tau) \Big|_{\partial \sigma} = 0, \\ \mathcal{V}^1(y', 0) &= \tilde{a}(y'), \quad \mathcal{W}_{2,1}(y', 0) = \tilde{b}^2(y'), \quad \mathcal{W}_{3,1}(y', 0) = \tilde{b}^3(y'), \end{aligned}$$

where  $\mathcal{V}^1(y', \tau) = V_\epsilon^1(\epsilon y', \epsilon^2 \tau)$ ,  $\mathcal{W}^{2,1}(y', \tau) = W_\epsilon^{2,1}(\epsilon y', \epsilon^2 \tau)$ ,  $\mathcal{W}^{3,1}(y', \tau) = W_\epsilon^{3,1}(\epsilon y', \epsilon^2 \tau)$ . The asymptotic expansion for  $(\mathcal{V}^1(y', \tau), \mathcal{W}^{2,1}(y', \tau), \mathcal{W}^{3,1}(y', \tau))$  is given in the form (3.18).

The zero-order approximation  $(\mathcal{V}_0^1(y', \tau), \mathcal{W}_0^{2,1}(y', \tau), \mathcal{W}_0^{3,1}(y', \tau))$  is given by:

$$\begin{aligned}
 & \frac{\partial \mathcal{V}_0^1(y', \tau)}{\partial \tau} - \mu \Delta_{y'} \mathcal{V}_0^1(y', \tau) = 0, \\
 & \frac{\partial \mathcal{W}_0^{2,1}(y', \tau)}{\partial \tau} - \alpha \Delta_{y'} \mathcal{W}_0^{2,1}(y', \tau) - \beta \frac{\partial}{\partial y_2} \left( \frac{\partial \mathcal{W}_0^{2,1}(y', \tau)}{\partial y_2} + \frac{\partial \mathcal{W}_0^{3,1}(y', \tau)}{\partial y_3} \right) = 0, \\
 & \frac{\partial \mathcal{W}_0^{3,1}(y', \tau)}{\partial \tau} - \alpha \Delta_{y'} \mathcal{W}_0^{3,1}(y', \tau) - \beta \frac{\partial}{\partial y_3} \left( \frac{\partial \mathcal{W}_0^{2,1}(y', \tau)}{\partial y_2} + \frac{\partial \mathcal{W}_0^{3,1}(y', \tau)}{\partial y_3} \right) = 0, \\
 & \mathcal{V}_0^1(y', \tau) \Big|_{\partial \sigma} = 0, \quad \mathcal{W}_0^{2,1}(y', \tau) \Big|_{\partial \sigma} = 0, \quad \mathcal{W}_0^{3,1}(y', \tau) \Big|_{\partial \sigma} = 0, \\
 & \mathcal{V}_0^1(y', 0) = \tilde{a}_0(y') - \tilde{V}_0^1(y', 0) \equiv \tilde{A}_0(y'), \\
 & \mathcal{W}_0^{2,1}(y', 0) = \tilde{b}_0^2(y') - \tilde{W}_0^{2,1}(y', 0) \equiv \tilde{B}_0^2(y'), \quad \mathcal{W}_0^{3,1}(y', 0) = \tilde{b}_0^3(y') - \tilde{W}_0^{3,1}(y', 0) \equiv \tilde{B}_0^3(y').
 \end{aligned} \tag{3.22}$$

The first-order corrector  $(\mathcal{V}_1^1(y', \tau), \mathcal{W}_1^{2,1}(y', \tau), \mathcal{W}_1^{3,1}(y', \tau))$  satisfies the following system:

$$\begin{aligned}
 & \frac{\partial \mathcal{V}_1^1(y', \tau)}{\partial \tau} - \mu \Delta_{y'} \mathcal{V}_1^1(y', \tau) = a \left( \frac{\partial \mathcal{W}_0^{3,1}(y', \tau)}{\partial y_2} - \frac{\partial \mathcal{W}_0^{2,1}(y', \tau)}{\partial y_3} \right), \\
 & \frac{\partial \mathcal{W}_1^{2,1}(y', \tau)}{\partial \tau} - \alpha \Delta_{y'} \mathcal{W}_1^{2,1}(y', \tau) - \beta \frac{\partial}{\partial y_2} \left( \frac{\partial \mathcal{W}_1^{2,1}(y', \tau)}{\partial y_2} + \frac{\partial \mathcal{W}_1^{3,1}(y', \tau)}{\partial y_3} \right) = a \frac{\partial \mathcal{V}_0^1(y', \tau)}{\partial y_3}, \\
 & \frac{\partial \mathcal{W}_1^{3,1}(y', \tau)}{\partial \tau} - \alpha \Delta_{y'} \mathcal{W}_1^{3,1}(y', \tau) - \beta \frac{\partial}{\partial y_3} \left( \frac{\partial \mathcal{W}_1^{2,1}(y', \tau)}{\partial y_2} + \frac{\partial \mathcal{W}_1^{3,1}(y', \tau)}{\partial y_3} \right) = -a \frac{\partial \mathcal{V}_0^1(y', \tau)}{\partial y_2}, \\
 & \mathcal{V}_1^1(y', \tau) \Big|_{\partial \sigma} = 0, \quad \mathcal{W}_1^{2,1}(y', \tau) \Big|_{\partial \sigma} = 0, \quad \mathcal{W}_1^{3,1}(y', \tau) \Big|_{\partial \sigma} = 0, \\
 & \mathcal{V}_1^1(y', 0) = \tilde{a}_1(y') - \tilde{V}_1^1(y', 0) \equiv \tilde{A}_1(y'), \\
 & \mathcal{W}_1^{2,1}(y', 0) = \tilde{b}_1^2(y') - \tilde{W}_1^{2,1}(y', 0) \equiv \tilde{B}_1^2(y'), \quad \mathcal{W}_1^{3,1}(y', 0) = \tilde{b}_1^3(y') - \tilde{W}_1^{3,1}(y', 0) \equiv \tilde{B}_1^3(y').
 \end{aligned} \tag{3.23}$$

Finally, the higher-order correctors  $(\mathcal{V}_j^1(y', \tau), \mathcal{W}_j^{2,1}(y', \tau), \mathcal{W}_j^{3,1}(y', \tau))$  ( $j = 2, \dots, J$ ), are given with the following:

$$\begin{aligned}
 & \frac{\partial \mathcal{V}_j^1(y', \tau)}{\partial \tau} - \mu \Delta_{y'} \mathcal{V}_j^1(y', \tau) = a \left( \frac{\partial \mathcal{W}_{j-1}^{3,1}(y', \tau)}{\partial y_2} - \frac{\partial \mathcal{W}_{j-1}^{2,1}(y', \tau)}{\partial y_3} \right), \\
 & \frac{\partial \mathcal{W}_j^{2,1}(y', \tau)}{\partial \tau} - \alpha \Delta_{y'} \mathcal{W}_j^{2,1}(y', \tau) - \beta \frac{\partial}{\partial y_2} \left( \frac{\partial \mathcal{W}_j^{2,1}(y', \tau)}{\partial y_2} + \frac{\partial \mathcal{W}_j^{3,1}(y', \tau)}{\partial y_3} \right) \\
 & \quad = a \frac{\partial \mathcal{V}_{j-1}^1(y', \tau)}{\partial y_3} - 2a \mathcal{W}_{j-2}^{2,1}(y', \tau), \\
 & \frac{\partial \mathcal{W}_j^{3,1}(y', \tau)}{\partial \tau} - \alpha \Delta_{y'} \mathcal{W}_j^{3,1}(y', \tau) - \beta \frac{\partial}{\partial y_3} \left( \frac{\partial \mathcal{W}_j^{2,1}(y', \tau)}{\partial y_2} + \frac{\partial \mathcal{W}_j^{3,1}(y', \tau)}{\partial y_3} \right) \\
 & \quad = -a \frac{\partial \mathcal{V}_{j-1}^1(y', \tau)}{\partial y_2} - 2a \mathcal{W}_{j-2}^{3,1}(y', \tau), \\
 & \mathcal{V}_j^1(y', \tau) \Big|_{\partial \sigma} = 0, \quad \mathcal{W}_j^{2,1}(y', \tau) \Big|_{\partial \sigma} = 0, \quad \mathcal{W}_j^{3,1}(y', \tau) \Big|_{\partial \sigma} = 0,
 \end{aligned} \tag{3.24}$$

$$\begin{aligned}\mathcal{V}_j^1(y', 0) &= \tilde{a}_j(y') - \tilde{V}_j^1(y', 0) \equiv \tilde{A}_j(y'), \\ \mathcal{W}_j^{2,1}(y', 0) &= \tilde{b}_j^1(y') - \tilde{W}_j^{2,1}(y', 0) \equiv \tilde{B}_j^2(y'), \quad \mathcal{W}_j^{3,1}(y', 0) = \tilde{b}_j^3(y') - \tilde{W}_j^{3,1}(y', 0) \equiv \tilde{B}_j^3(y').\end{aligned}\tag{3.25}$$

The existence and uniqueness results related to the problems (3.22)–(3.25) are formulated in the sequel.

The following theorem may be proved in much the same way as in [13, Chapter VII, Section 7.1, Theorem 3 and Theorem 4].

**Theorem 3.4** (Existence and uniqueness – MHP velocity boundary layer).

Let  $\tilde{A}_j \in W_0^{1,2}(\sigma)$  and  $h_j \in L^2(0, \infty; L^2(\sigma))$  ( $j = 0, 1, \dots, J$ ). Then there exists a unique weak solution  $\mathcal{V}_j^1 \in L^2(0, \infty; W_0^{1,2}(\sigma)) \cap W^{1,2}(0, \infty; L^2(\sigma))$  of the problem

$$\begin{aligned}\frac{\partial \mathcal{V}_j^1(y', \tau)}{\partial \tau} - \mu \Delta_{y'} \mathcal{V}_j^1(y', \tau) &= h_j(y', \tau), \\ \mathcal{V}_j^1(y', \tau)|_{\partial \sigma} &= 0, \quad \mathcal{V}_j^1(y', 0) = \tilde{A}_j(y'),\end{aligned}\tag{3.26}$$

satisfying for all  $t \in [0, \infty)$  the integral identity:

$$\int_0^t \int_{\sigma} \frac{\partial \mathcal{V}_j^1}{\partial \tau} \eta \, dy' d\tau + \mu \int_0^t \int_{\sigma} \nabla_{y'} \mathcal{V}_j^1 \cdot \nabla_{y'} \eta \, dy' d\tau = \int_0^t \int_{\sigma} h_j \eta \, dy' d\tau, \quad \forall \eta \in L^2(0, \infty; W_0^{1,2}(\sigma)).$$

Moreover, there holds the estimate

$$\begin{aligned}\|\mathcal{V}_j^1\|_{L^\infty(0, \infty; W^{1,2}(\sigma))} + \|\mathcal{V}_j^1\|_{L^2(0, \infty; W^{1,2}(\sigma))} + \left\| \frac{\partial \mathcal{V}_j^1}{\partial \tau} \right\|_{L^2(0, \infty; L^2(\sigma))} \\ \leq c(\|\tilde{A}_j\|_{W^{1,2}(\sigma)} + \|h_j\|_{L^2(0, \infty; L^2(\sigma))}).\end{aligned}$$

The following theorem is a consequence of the result that can be found in [22, Chapter III, Section 2.3, Lemma 2.3.1].

**Theorem 3.5** (Existence and uniqueness – MHP microrotation boundary layer).

Let  $\tilde{\mathbf{B}}_j = (\tilde{B}_j^2, \tilde{B}_j^3) \in W_0^{1,2}(\sigma)^2$  and  $\mathbf{h}_j \in L^2(0, \infty; L^2(\sigma)^2)$  ( $j = 0, 1, \dots, J$ ). Then there exists a unique weak solution  $\mathcal{W}_j^a = (\mathcal{W}_j^{2,1}, \mathcal{W}_j^{3,1}) \in L^2(0, \infty; W_0^{1,2}(\sigma)^2) \cap W^{1,2}(0, \infty; L^2(\sigma)^2)$  of the problem

$$\begin{aligned}\frac{\partial \mathcal{W}_j^a(y', \tau)}{\partial \tau} - \alpha \Delta_{y'} \mathcal{W}_j^a(y', \tau) - \beta \nabla_{y'}(\operatorname{div}_{y'} \mathcal{W}_j^a(y', \tau)) &= \mathbf{h}_j(y', \tau), \\ \mathcal{W}_j^a(y', \tau)|_{\partial \sigma} &= \mathbf{0}, \quad \mathcal{W}_j^a(y', 0) = \tilde{\mathbf{B}}_j(y'),\end{aligned}\tag{3.27}$$



satisfying for all  $t \in [0, \infty)$  the integral identity:

$$\begin{aligned} \int_0^t \int_\sigma \frac{\partial \mathcal{W}_j^a}{\partial \tau} \cdot \boldsymbol{\eta} \, dy' d\tau + \alpha \int_0^t \int_\sigma \nabla_{y'} \mathcal{W}_j^a \cdot \nabla_{y'} \boldsymbol{\eta} \, dy' d\tau + \beta \int_0^t \int_\sigma \operatorname{div} \mathcal{W}_j^a \operatorname{div} \boldsymbol{\eta} \, dy' d\tau \\ = \int_0^t \int_\sigma \mathbf{h}_j \cdot \boldsymbol{\eta} \, dy' d\tau, \quad \forall \boldsymbol{\eta} \in L^2(0, \infty, W_0^{1,2}(\sigma)^2). \end{aligned}$$

Furthermore, there holds the estimate

$$\begin{aligned} \|\mathcal{W}_j^a\|_{L^\infty(0, \infty; W^{1,2}(\sigma)^2)} + \|\mathcal{W}_j^a\|_{L^2(0, \infty; W^{1,2}(\sigma)^2)} + \left\| \frac{\partial \mathcal{W}_j^a}{\partial \tau} \right\|_{L^2(0, \infty; L^2(\sigma)^2)} \\ \leq c(\|\tilde{\mathbf{B}}_j\|_{W^{1,2}(\sigma)^2} + \|\mathbf{h}_j\|_{L^2(0, \infty; L^2(\sigma)^2)}). \end{aligned}$$

Now we provide the results guaranteeing the exponential decay to zero (as  $\tau \rightarrow \infty$ ) for the boundary layer functions  $(\mathcal{V}_j^1(y', \tau), \mathcal{W}_j^{2,1}(y', \tau), \mathcal{W}_j^{3,1}(y', \tau))$  ( $j = 0, 1, \dots, J$ ).

**Theorem 3.6** (Exponential decay as  $\tau \rightarrow \infty$  – MHP velocity boundary layer).

Let  $\tilde{A}_j \in W_0^{1,2}(\sigma)$  and  $h_j \in L^2(0, \infty; L^2(\sigma))$  ( $j = 0, 1, \dots, J$ ) be functions exponentially decaying to zero as  $\tau \rightarrow \infty$ . Then the solution  $\mathcal{V}_j^1 \in L^2(0, \infty; W_0^{1,2}(\sigma)) \cap W^{1,2}(0, \infty; L^2(\sigma))$  of the problem (3.26) satisfies the following estimate:

$$\begin{aligned} \max_{\tau \in [0, \infty)} \left[ \exp\left(\frac{\gamma_*}{2}\tau\right) \left( \int_\sigma |\mathcal{V}_j^1(y', \tau)|^2 \, dy' + \mu \int_\sigma |\nabla_{y'} \mathcal{V}_j^1(y', \tau)|^2 \, dy' \right) \right] \\ + \int_0^\infty \exp\left(\frac{\gamma_*}{2}\tau\right) \int_\sigma \left( \left| \frac{\partial \mathcal{V}_j^1(y', \tau)}{\partial \tau} \right|^2 + |\mathcal{V}_j^1(y', \tau)|^2 + |\nabla_{y'} \mathcal{V}_j^1(y', \tau)|^2 \right) dy' d\tau \quad (3.28) \\ \leq c \left( \|\tilde{A}_j(y')\|_{W^{1,2}(\sigma)}^2 + \|\exp(\delta_* \tau) h_j(y', \tau)\|_{L^2(0, \infty; L^2(\sigma))}^2 \right), \end{aligned}$$

where  $\gamma_* = \min\{\lambda_1, 1, \mu\}$ ,  $\delta_* = \frac{\gamma_*}{4}$  and  $\lambda_1$  is the first eigenvalue of the Dirichlet problem for the Laplace equation

$$\begin{aligned} -\mu \Delta_{y'} u(y') &= \lambda u(y'), \quad y' \in \sigma, \\ u(y')|_{\partial\sigma} &= 0. \end{aligned} \quad (3.29)$$

*Proof.* The result is proved by extending Theorem 2.2 from [27] for  $h_j \neq 0$ .

First, let us note that the Poincaré inequality holds:

$$\int_\sigma |\mathcal{V}_j^1(y', \tau)|^2 dy' \leq \frac{\mu}{\lambda_1} \int_\sigma |\nabla_{y'} \mathcal{V}_j^1(y', \tau)|^2 dy', \quad (3.30)$$

valid for every function  $\mathcal{V}_j^1 \in L^2(0, \infty; W_0^{1,2}(\sigma)) \cap W^{1,2}(0, \infty; L^2(\sigma))$  (see [33, Chapter I, Section 1.1.2., Lemma 1.1]).

We multiply (3.26)<sub>1</sub> with  $\mathcal{V}_j^1$  and integrate by parts to derive the following:

$$\frac{1}{2} \frac{d}{d\tau} \int_{\sigma} |\mathcal{V}_j^1(y', \tau)|^2 dy' + \mu \int_{\sigma} |\nabla_{y'} \mathcal{V}_j^1(y', \tau)|^2 dy' = \int_{\sigma} h_j(y', \tau) \mathcal{V}_j^1(y', \tau) dy'. \quad (3.31)$$

Applying Young's inequality in equation (3.31) with  $\delta = \frac{1}{\lambda_1}$  and using the Poincaré inequality (3.30) we get:

$$\frac{1}{2} \frac{d}{d\tau} \int_{\sigma} |\mathcal{V}_j^1(y', \tau)|^2 dy' + \frac{\mu}{2} \int_{\sigma} |\nabla_{y'} \mathcal{V}_j^1(y', \tau)|^2 dy' \leq \frac{1}{2\lambda_1} \int_{\sigma} |h_j(y', \tau)|^2 dy'. \quad (3.32)$$

Multiplying (3.26)<sub>1</sub> by  $\frac{\partial \mathcal{V}_j^1(y', \tau)}{\partial \tau}$  and integrating by parts, we derive the relation:

$$\int_{\sigma} \left| \frac{\partial \mathcal{V}_j^1(y', \tau)}{\partial \tau} \right|^2 dy' + \frac{\mu}{2} \frac{d}{d\tau} \int_{\sigma} |\nabla_{y'} \mathcal{V}_j^1(y', \tau)|^2 dy' = \int_{\sigma} h_j(y', \tau) \frac{\partial \mathcal{V}_j^1(y', \tau)}{\partial \tau} dy'. \quad (3.33)$$

Applying Young's inequality with  $\delta = 1$  in (3.33) we get:

$$\frac{1}{2} \int_{\sigma} \left| \frac{\partial \mathcal{V}_j^1(y', \tau)}{\partial \tau} \right|^2 dy' + \frac{\mu}{2} \frac{d}{d\tau} \int_{\sigma} |\nabla_{y'} \mathcal{V}_j^1(y', \tau)|^2 dy' \leq \frac{1}{2} \int_{\sigma} |h_j(y', \tau)|^2 dy'. \quad (3.34)$$

Combining (3.32) and (3.34), we have:

$$\begin{aligned} \frac{d}{d\tau} \int_{\sigma} (|\mathcal{V}_j^1(y', \tau)|^2 + \mu |\nabla_{y'} \mathcal{V}_j^1(y', \tau)|^2) dy' + \mu \int_{\sigma} |\nabla_{y'} \mathcal{V}_j^1(y', \tau)|^2 dy' \\ + \int_{\sigma} \left| \frac{\partial \mathcal{V}_j^1(y', \tau)}{\partial \tau} \right|^2 dy' \leq c \int_{\sigma} |h_j(y', \tau)|^2 dy'. \end{aligned}$$

Applying the Poincaré inequality (3.30) to the above equation and setting  $\gamma_* = \min\{\lambda_1, 1, \mu\}$ , we obtain the following inequality:

$$\begin{aligned} \frac{d}{d\tau} \int_{\sigma} (|\mathcal{V}_j^1(y', \tau)|^2 + \mu |\nabla_{y'} \mathcal{V}_j^1(y', \tau)|^2) dy' + \gamma_* \left( \int_{\sigma} |\mathcal{V}_j^1(y', \tau)|^2 dy' + \mu \int_{\sigma} |\nabla_{y'} \mathcal{V}_j^1(y', \tau)|^2 dy' \right) \\ + \int_{\sigma} \left| \frac{\partial \mathcal{V}_j^1(y', \tau)}{\partial \tau} \right|^2 dy' \leq c \int_{\sigma} |h_j(y', \tau)|^2 dy'. \end{aligned} \quad (3.35)$$

We now multiply (3.35) by  $\exp(\frac{\gamma_*}{2}\tau)$  and integrate over  $\tau$  to obtain:

$$\begin{aligned} \exp\left(\frac{\gamma_*}{2}\tau\right) \left( \int_{\sigma} |\mathcal{V}_j^1(y', \tau)|^2 dy' + \mu \int_{\sigma} |\nabla_{y'} \mathcal{V}_j^1(y', \tau)|^2 dy' \right) \\ + \int_0^{\tau} \exp\left(\frac{\gamma_*}{2}t\right) \int_{\sigma} \left| \frac{\partial \mathcal{V}_j^1(y', t)}{\partial t} \right|^2 dy' dt \\ + \frac{\gamma_*}{2} \int_0^{\tau} \exp\left(\frac{\gamma_*}{2}t\right) \left( \int_{\sigma} |\mathcal{V}_j^1(y', t)|^2 dy' + \mu \int_{\sigma} |\nabla_{y'} \mathcal{V}_j^1(y', t)|^2 dy' \right) dt \\ \leq \|\tilde{A}_j\|_{W^{1,2}(\sigma)}^2 + c \int_0^{\tau} \exp\left(\frac{\gamma_*}{2}t\right) \int_{\sigma} |h_j(y', t)|^2 dy' dt. \end{aligned} \quad (3.36)$$

Finally, taking the maximum over  $\tau$  in (3.36), we get the estimate (3.28).  $\square$

Using the same arguments as above, one can straightforwardly prove:

**Theorem 3.7** (Exponential decay as  $\tau \rightarrow \infty$  – MHP microrotation boundary layer).

Let  $\tilde{\mathbf{B}}_j = (\tilde{B}_j^2, \tilde{B}_j^3) \in W_0^{1,2}(\sigma)^2$  and  $\mathbf{h}_j \in L^2(0, \infty; L^2(\sigma)^2)$  ( $j = 0, 1, \dots, J$ ) be functions exponentially decaying to zero as  $\tau \rightarrow \infty$ . Then the solution  $\mathbf{W}_j^a = (\mathcal{W}_j^{2,1}, \mathcal{W}_j^{3,1}) \in L^2(0, \infty; W_0^{1,2}(\sigma)^2) \cap W^{1,2}(0, \infty; L^2(\sigma)^2)$  of the problem (3.27) satisfies the following estimate:

$$\begin{aligned} & \max_{\tau \in [0, \infty)} \left[ \exp\left(\frac{\gamma_*}{2}\tau\right) \left( \int_{\sigma} |\mathbf{W}_j^a(y', \tau)|^2 dy' + \alpha \int_{\sigma} |\nabla_{y'} \mathbf{W}_j^a(y', \tau)|^2 dy' \right) \right] \\ & + \int_0^{\infty} \exp\left(\frac{\gamma_*}{2}\tau\right) \int_{\sigma} \left( \left| \frac{\partial \mathbf{W}_j^a(y', \tau)}{\partial \tau} \right|^2 + |\mathbf{W}_j^a(y', \tau)|^2 + |\nabla_{y'} \mathbf{W}_j^a(y', \tau)|^2 \right) dy' d\tau \\ & \leq c \left( \|\tilde{\mathbf{B}}_j(y')\|_{W^{1,2}(\sigma)^2}^2 + \|\exp(\delta_* \tau) \mathbf{h}_j(y', \tau)\|_{L^2(0, \infty; L^2(\sigma)^2)}^2 \right), \end{aligned}$$

where  $\gamma_* = \min\{\lambda_1, 1, \alpha\}$ ,  $\delta_* = \frac{\gamma_*}{4}$  and  $\lambda_1$  is the first eigenvalue of the problem

$$\begin{aligned} -\alpha \Delta_{y'} \mathbf{U}(y') &= \lambda \mathbf{U}(y'), \quad y' \in \sigma, \\ \mathbf{U}(y')|_{\partial\sigma} &= \mathbf{0}. \end{aligned}$$

### 3.3 Micropolar Inverse Problem (MIP)

Now we turn our attention to the micropolar inverse problem (3.11). The solution of the micropolar heat problem (3.10) is given with (3.17)–(3.18). Therefore, from (3.12) and (3.14)<sub>3</sub>, we have the following:

$$\begin{aligned} H(t) &= \sum_{j=0}^J \epsilon^{j+4} F_j(t) - \sum_{j=0}^J \int_{\sigma_{\epsilon}} \epsilon^{j+2} \left( \tilde{V}_j^1\left(\frac{x'}{\epsilon}, t\right) + \mathcal{V}_j^1\left(\frac{x'}{\epsilon}, \frac{t}{\epsilon^2}\right) \right) dx' \\ &= \sum_{j=0}^J \epsilon^{j+4} F_j(t) - \sum_{j=0}^J \int_{\sigma} \epsilon^{j+4} \left( \tilde{V}_j^1(y', t) + \mathcal{V}_j^1\left(y', \frac{t}{\epsilon^2}\right) \right) dy' \\ &= \sum_{j=0}^J \epsilon^{j+4} \left( H_j(t) + \mathcal{H}_j\left(\frac{t}{\epsilon^2}\right) \right). \end{aligned}$$

where we denote

$$H_j(t) = F_j(t) - \int_{\sigma} \tilde{V}_j^1(y', t) dy', \quad \mathcal{H}_j(\tau) = - \int_{\sigma} \mathcal{V}_j^1(y', \tau) dy'.$$

The compatibility condition

$$H_j(0) + \mathcal{H}_j(0) = 0, \quad j = 0, 1, \dots, J,$$

now follows directly from (3.13). We can rewrite the above condition as:

$$F_j(0) = \int_{\sigma} \tilde{a}_j(y') dy', \quad j = 0, 1, \dots, J.$$

Making the change of variables  $y' = \frac{x'}{\epsilon}$  and putting the pressure as  $q(t) = \frac{1}{\epsilon^2} s(t)$ , from (3.11) we deduce the following problem posed on  $\sigma$ :

$$\begin{aligned} -\mu \Delta_{y'} \tilde{V}^2(y', t) &= a\epsilon \left( \frac{\partial \tilde{W}^{3,2}(y', t)}{\partial y_2} - \frac{\partial \tilde{W}^{2,2}(y', t)}{\partial y_3} \right) + s(t) - \epsilon^2 \frac{\partial \tilde{V}^2(y', t)}{\partial t}, \\ &- \alpha \Delta_{y'} \tilde{W}^{2,2}(y', t) - \beta \frac{\partial}{\partial y_2} \left( \frac{\partial \tilde{W}^{2,2}(y', t)}{\partial y_2} + \frac{\partial \tilde{W}^{3,2}(y', t)}{\partial y_3} \right) \\ &= a\epsilon \frac{\partial \tilde{V}^2(y', t)}{\partial y_3} - \epsilon^2 \frac{\partial \tilde{W}^{2,2}(y', t)}{\partial t} - 2a\epsilon^2 \tilde{W}^{2,2}(y', t), \\ &- \alpha \Delta_{y'} \tilde{W}^{3,2}(y', t) - \beta \frac{\partial}{\partial y_3} \left( \frac{\partial \tilde{W}^{2,2}(y', t)}{\partial y_2} + \frac{\partial \tilde{W}^{3,2}(y', t)}{\partial y_3} \right) \\ &= -a\epsilon \frac{\partial \tilde{V}^2(y', t)}{\partial y_2} - \epsilon^2 \frac{\partial \tilde{W}^{3,2}(y', t)}{\partial t} - 2a\epsilon^2 \tilde{W}^{3,2}(y', t), \\ \tilde{V}^2(y', t) \Big|_{\partial\sigma} &= 0, \quad \tilde{W}^{2,2}(y', t) \Big|_{\partial\sigma} = 0, \quad \tilde{W}^{3,2}(y', t) \Big|_{\partial\sigma} = 0, \\ \tilde{V}^2(y', 0) &= 0, \quad \tilde{W}^{2,2}(y', 0) = 0, \quad \tilde{W}^{3,2}(y', 0) = 0, \\ \int_{\sigma} \tilde{V}^2(y', t) dy' &= \epsilon^{-2} H(t). \end{aligned} \tag{3.37}$$

As for the micropolar heat problem, we expand in the following way:

$$\begin{aligned} \tilde{V}_{\epsilon, [J]}^2(y', t) &= \sum_{j=0}^J \epsilon^{j+2} \tilde{V}_j^2(y', t), \quad s_{\epsilon, [J]}(t) = \sum_{j=0}^J \epsilon^{j+2} s_j(t), \\ \tilde{W}_{\epsilon, [J]}^{2,2}(y', t) &= \sum_{j=0}^J \epsilon^{j+2} \tilde{W}_j^{2,2}(y', t), \quad \tilde{W}_{\epsilon, [J]}^{3,2}(y', t) = \sum_{j=0}^J \epsilon^{j+2} \tilde{W}_j^{3,2}(y', t), \end{aligned} \tag{3.38}$$

with the boundary-layer-correctors in time (after change of variable  $\tau = \frac{t}{\epsilon^2}$ ):

$$\begin{aligned} \mathcal{V}_{\epsilon, [J]}^2(y', \tau) &= \sum_{j=0}^J \epsilon^{j+2} \mathcal{V}_j^2(y', \tau), \quad \mathcal{S}_{\epsilon, [J]}(\tau) = \sum_{j=0}^J \epsilon^{j+2} \mathcal{S}_j(\tau), \\ \mathcal{W}_{\epsilon, [J]}^{2,2}(y', \tau) &= \sum_{j=0}^J \epsilon^{j+2} \mathcal{W}_j^{2,2}(y', \tau), \quad \mathcal{W}_{\epsilon, [J]}^{3,2}(y', \tau) = \sum_{j=0}^J \epsilon^{j+2} \mathcal{W}_j^{3,2}(y', \tau). \end{aligned} \tag{3.39}$$

### 3.3.1 Regular Part of the Asymptotic Expansion

We now substitute the regular part (3.38) of the expansion into the micropolar inverse problem (3.37) and collect the terms with the same powers of  $\epsilon$ .

#### Zero-order approximation

For the zero-order approximation  $(\tilde{V}_0^2(y', t), \tilde{W}_0^{2,2}(y', t), \tilde{W}_0^{3,2}(y', t), s_0(t))$  we get:

$$\begin{aligned} -\mu\Delta_{y'}\tilde{V}_0^2(y', t) &= s_0(t), \\ -\alpha\Delta_{y'}\tilde{W}_0^{2,2}(y', t) - \beta\frac{\partial}{\partial y_2}\left(\frac{\partial\tilde{W}_0^{2,2}(y', t)}{\partial y_2} + \frac{\partial\tilde{W}_0^{3,2}(y', t)}{\partial y_3}\right) &= 0, \\ -\alpha\Delta_{y'}\tilde{W}_0^{3,2}(y', t) - \beta\frac{\partial}{\partial y_3}\left(\frac{\partial\tilde{W}_0^{2,2}(y', t)}{\partial y_2} + \frac{\partial\tilde{W}_0^{3,2}(y', t)}{\partial y_3}\right) &= 0, \\ \tilde{V}_0^2(y', t)|_{\partial\sigma} &= 0, \quad \tilde{W}_0^{2,2}(y', t)|_{\partial\sigma} = 0, \quad \tilde{W}_0^{3,2}(y', t)|_{\partial\sigma} = 0. \\ \int_{\sigma}\tilde{V}_0^2(y', t)dy' &= H_0(t). \end{aligned}$$

Let  $\chi^0(y')$  be the solution of the Dirichlet problem for the Poisson equation

$$\begin{aligned} -\mu\Delta_{y'}\chi^0(y') &= 1, \quad y' \in \sigma, \\ \chi^0(y')|_{\partial\sigma} &= 0. \end{aligned}$$

As in [27], we seek for the velocity zero-order approximation in the following form:

$$\tilde{V}_0^2(y', t) = \chi^0(y')s_0(t),$$

where we choose  $s_0(t)$  to satisfy the flux condition:

$$s_0(t) = \kappa_0^{-1}H_0(t), \quad \kappa_0 = \int_{\sigma}\chi^0(y')dy'.$$

Consequently, we obtain

$$\tilde{V}_0^2(y', t) = \kappa_0^{-1}H_0(t)\chi^0(y'). \quad (3.40)$$

The zero-order approximation for the microrotation can now easily be verified as

$$(\tilde{W}_0^{2,2}(y', t), \tilde{W}_0^{3,2}(y', t)) \equiv (0, 0). \quad (3.41)$$

### First-order corrector

Let us now consider the system of equations on  $\sigma$  for the first-order corrector

$(\tilde{V}_1^2(y', t), \tilde{W}_1^{2,2}(y', t), \tilde{W}_1^{3,2}(y', t), s_1(t))$ :

$$\begin{aligned}
 -\mu\Delta_{y'}\tilde{V}_1^2(y', t) &= a\left(\frac{\partial\tilde{W}_0^{3,2}(y', t)}{\partial y_2} - \frac{\partial\tilde{W}_0^{2,2}(y', t)}{\partial y_3}\right) + s_1(t), \\
 -\alpha\Delta_{y'}\tilde{W}_1^{2,2}(y', t) - \beta\frac{\partial}{\partial y_2}\left(\frac{\partial\tilde{W}_1^{2,2}(y', t)}{\partial y_2} + \frac{\partial\tilde{W}_1^{3,2}(y', t)}{\partial y_3}\right) &= a\frac{\partial\tilde{V}_0^2(y', t)}{\partial y_3}, \\
 -\alpha\Delta_{y'}\tilde{W}_1^{3,2}(y', t) - \beta\frac{\partial}{\partial y_3}\left(\frac{\partial\tilde{W}_1^{2,2}(y', t)}{\partial y_2} + \frac{\partial\tilde{W}_1^{3,2}(y', t)}{\partial y_3}\right) &= -a\frac{\partial\tilde{V}_0^2(y', t)}{\partial y_2}, \\
 \tilde{V}_1^2(y', t)\Big|_{\partial\sigma} &= 0, \quad \tilde{W}_1^{2,2}(y', t)\Big|_{\partial\sigma} = 0, \quad \tilde{W}_1^{3,2}(y', t)\Big|_{\partial\sigma} = 0. \\
 \int_{\sigma}\tilde{V}_1^2(y', t)dy' &= H_1(t).
 \end{aligned} \tag{3.42}$$

As for the zero-order approximation, we can explicitly compute the first-order corrector of the velocity. Plugging (3.41) into (3.42)<sub>1</sub>, we get the equation of the same structure as for the zero-order approximation. In view of that, we have the explicit expression for the first-order corrector:

$$\tilde{V}_1^2(y', t) = \kappa_0^{-1}H_1(t)\chi_0(y'),$$

while the pressure is given by

$$s_1(t) = \kappa_0^{-1}H_1(t).$$

Plugging (3.40) into (3.42)<sub>2</sub>–(3.42)<sub>3</sub>, we get the following system of equations for the microrotation first-order corrector:

$$\begin{aligned}
 -\alpha\Delta_{y'}\tilde{W}_1^{2,2}(y', t) - \beta\frac{\partial}{\partial y_2}\left(\frac{\partial\tilde{W}_1^{2,2}(y', t)}{\partial y_2} + \frac{\partial\tilde{W}_1^{3,2}(y', t)}{\partial y_3}\right) &= \frac{aH_0(t)}{\kappa_0}\frac{\partial\chi_0(y')}{\partial y_3}, \\
 -\alpha\Delta_{y'}\tilde{W}_1^{3,2}(y', t) - \beta\frac{\partial}{\partial y_3}\left(\frac{\partial\tilde{W}_1^{2,2}(y', t)}{\partial y_2} + \frac{\partial\tilde{W}_1^{3,2}(y', t)}{\partial y_3}\right) &= -\frac{aH_0(t)}{\kappa_0}\frac{\partial\chi_0(y')}{\partial y_2}, \\
 \tilde{W}_1^{2,2}(y', t)\Big|_{\partial\sigma} &= 0, \quad \tilde{W}_1^{3,2}(y', t)\Big|_{\partial\sigma} = 0.
 \end{aligned}$$

Since the structure of the above system is far more complex than for the velocity and since the right-hand side is not independent of the cross-section variable  $y'$ , it is not likely that the above system can be explicitly solved. However, such a problem admits a unique solution (see Theorem 3.2).

### Higher-order correctors

The system satisfied by the higher-order correctors  $(\tilde{V}_j^2(y', t), \tilde{W}_j^{2,2}(y', t), \tilde{W}_j^{3,2}(y', t), s_j(t))$  ( $j = 2, \dots, J$ ) is given by:

$$\begin{aligned}
 -\mu\Delta_{y'}\tilde{V}_j^2(y', t) &= a\left(\frac{\partial\tilde{W}_{j-1}^{3,2}(y', t)}{\partial y_2} - \frac{\partial\tilde{W}_{j-1}^{2,2}(y', t)}{\partial y_3}\right) + s_j(t) - \frac{\partial\tilde{V}_{j-2}^2(y', t)}{\partial t}, \\
 &- \alpha\Delta_{y'}\tilde{W}_j^{2,2}(y', t) - \beta\frac{\partial}{\partial y_2}\left(\frac{\partial\tilde{W}_j^{2,2}(y', t)}{\partial y_2} + \frac{\partial\tilde{W}_j^{3,2}(y', t)}{\partial y_3}\right) \\
 &= a\frac{\partial\tilde{V}_{j-1}^2(y', t)}{\partial y_3} - \frac{\partial\tilde{W}_{j-2}^{2,2}(y', t)}{\partial t} - 2a\tilde{W}_{j-2}^{2,2}(y', t), \\
 &- \alpha\Delta_{y'}\tilde{W}_j^{3,2}(y', t) - \beta\frac{\partial}{\partial y_3}\left(\frac{\partial\tilde{W}_j^{2,2}(y', t)}{\partial y_2} + \frac{\partial\tilde{W}_j^{3,2}(y', t)}{\partial y_3}\right) \\
 &= -a\frac{\partial\tilde{V}_{j-1}^2(y', t)}{\partial y_2} - \frac{\partial\tilde{W}_{j-2}^{3,2}(y', t)}{\partial t} - 2a\tilde{W}_{j-2}^{3,2}(y', t), \\
 \tilde{V}_j^2(y', t)|_{\partial\sigma} &= 0, \quad \tilde{W}_j^{2,2}(y', t)|_{\partial\sigma} = 0, \quad \tilde{W}_j^{3,2}(y', t)|_{\partial\sigma} = 0, \\
 \int_{\sigma}\tilde{V}_j^2(y', t)dy' &= H_j(t).
 \end{aligned}$$

The existence and uniqueness result for the velocity and pressure is formulated in the following theorem.

**Theorem 3.8** (Existence and uniqueness – MIP velocity/pressure regular part).

Let  $H_j \in W^{1,2}(\langle 0, \infty \rangle)$  and  $h_j \in L^2(0, \infty; L^2(\sigma))$  ( $j = 2, \dots, J$ ). Let there also hold the compatibility condition

$$H_j(0) = F_j(0) - \int_{\sigma}\tilde{V}_j^1(y', 0)dy'.$$

Then there exists a unique weak solution  $(\tilde{V}_j^2, s_j) \in L^2(0, \infty; W_0^{1,2}(\sigma)) \times L^2(\langle 0, \infty \rangle)$  of the problem

$$\begin{aligned}
 -\mu\Delta_{y'}\tilde{V}_j^2(y', t) &= s_j(t) + h_j(y', t), \\
 \tilde{V}_j^2(y', t)|_{\partial\sigma} &= 0, \\
 \int_{\sigma}\tilde{V}_j^2(y', t)dy' &= H_j(t),
 \end{aligned}$$

satisfying for all  $t \in [0, \infty)$  the integral identity:

$$\mu \int_0^t \int_{\sigma} \nabla_{y'} \tilde{V}_j^2 \cdot \nabla_{y'} \eta \, dx' \, d\tau = \int_0^t s_j(\tau) \int_{\sigma} \eta \, dx' \, d\tau + \int_0^t \int_{\sigma} h_j \eta \, dx' \, d\tau, \quad \forall \eta \in L^2(0, \infty; W_0^{1,2}(\sigma)),$$

Furthermore, there holds the estimate

$$\|\tilde{V}_j^2\|_{L^2(0, \infty; W^{1,2}(\sigma))} + \|s_j\|_{L^2(\langle 0, \infty \rangle)} \leq c(\|H_j\|_{W^{1,2}(\langle 0, \infty \rangle)} + \|h_j\|_{L^2(0, \infty; L^2(\sigma))}). \quad (3.43)$$

*Proof.* To prove the above assertions, we follow the ideas from [33, Chapter II, Section 2.1.2] and look for the solution  $\tilde{V}_j^2(y', t)$  in the form  $\tilde{V}_j^2(y', t) = \hat{V}(y', t) + \bar{V}(y', t)$ . Here  $\bar{V}(y', t)$  satisfies the problem

$$\begin{aligned} -\mu\Delta_{y'}\bar{V}(y', t) &= h_j(y', t), \\ \bar{V}(y', t)|_{\partial\sigma} &= 0, \end{aligned} \tag{3.44}$$

whereas  $\hat{V}(y', t) = s_j(t)\hat{V}^0(y')$ , with  $\hat{V}^0(y')$  being the solution of the problem

$$\begin{aligned} -\mu\Delta_{y'}\hat{V}^0(y') &= 1, \\ \hat{V}^0(y')|_{\partial\sigma} &= 0. \end{aligned} \tag{3.45}$$

$s^j(t)$  is computed from the equation

$$s_j(t) \int_{\sigma} \hat{V}^0(y') dy' = H_j(t) - \int_{\sigma} \bar{V}(y', t) dy'.$$

This can be done because

$$\int_{\sigma} \hat{V}^0(y') dy' = \mu \int_{\sigma} |\nabla \hat{V}^0(y')|^2 dy' := \mu\kappa_1 > 0.$$

It is worth noting that both problems, (3.44) and (3.45), are uniquely solvable for almost every  $t > 0$ . Taking

$$s_j(t) = \frac{1}{\mu\kappa_1} \left( H_j(t) - \int_{\sigma} \bar{V}(y', t) dy' \right), \tag{3.46}$$

the prescribed flux condition can be verified as

$$\int_{\sigma} \tilde{V}_j^2(y', t) dy' = \int_{\sigma} (\hat{V}(y', t) + \bar{V}(y', t)) dy' = \int_{\sigma} (s_j(t)\hat{V}_0(y') + \bar{V}(y', t)) dy' = H_j(t).$$

The following estimate now follows from the well-known results for the Poisson equation and (3.46):

$$\|\tilde{V}_j^2(t)\|_{W^{1,2}(\sigma)} + |s_j(t)| \leq c \left( |H_j(t)| + \|h^j(t)\|_{L^2(\sigma)} \right) \tag{3.47}$$

for a.e.  $t > 0$  ( $c$  does not depend on  $t$ ). Finally, raising (3.47) and integrating with respect to time we get (3.43). □

On the other hand, the equations for the higher order correctors for the microrotation are linear second-order parabolic partial differential equations of a more general form. Nevertheless, the existence and uniqueness of the corresponding solution can be established using Theorem 3.2.

**Remark 3.9.** *The explicit formulae for  $(\tilde{V}_2^j(y', t), \tilde{W}_{2,2}^j(y', t), \tilde{W}_{3,2}^j(y', t), s^j(t))$  ( $j = 0, 1, 2$ ) can be derived in the case when the cross section  $\sigma$  is circular (see Appendix A).*



### 3.3.2 Boundary Layer in Time

We now construct the boundary layer in time for the micropolar inverse problem to correct our approximation. Making change of variables  $\tau = \frac{t}{\epsilon^2}$  in the system of equations (3.37), we get:

$$\begin{aligned} \frac{\partial \mathcal{V}^2(y', \tau)}{\partial \tau} - \mu \Delta_{y'} \mathcal{V}^2(y', \tau) &= a\epsilon \left( \frac{\partial \mathcal{W}^{3,2}(y', \tau)}{\partial y_2} - \frac{\partial \mathcal{W}^{2,2}(y', \tau)}{\partial y_3} \right) + \mathcal{S}(\tau), \\ \frac{\partial \mathcal{W}^{2,2}(y', \tau)}{\partial \tau} - \alpha \Delta_{y'} \mathcal{W}^{2,2}(y', \tau) - \beta \frac{\partial}{\partial y_2} \left( \frac{\partial \mathcal{W}^{2,2}(y', \tau)}{\partial y_2} + \frac{\partial \mathcal{W}^{3,2}(y', \tau)}{\partial y_3} \right) \\ &= a\epsilon \frac{\partial \mathcal{V}^2(y', \tau)}{\partial y_3} - 2a\epsilon^2 \mathcal{W}^{2,2}(y', \tau), \\ \frac{\partial \mathcal{W}^{3,2}(y', \tau)}{\partial \tau} - \alpha \Delta_{y'} \mathcal{W}^{3,2}(y', \tau) - \beta \frac{\partial}{\partial y_3} \left( \frac{\partial \mathcal{W}^{2,2}(y', \tau)}{\partial y_2} + \frac{\partial \mathcal{W}^{3,2}(y', \tau)}{\partial y_3} \right) \\ &= -a\epsilon \frac{\partial \mathcal{V}^2(y', \tau)}{\partial y_2} - 2a\epsilon^2 \mathcal{W}^{3,2}(y', \tau), \\ \mathcal{V}_2(y', \tau) \Big|_{\partial \sigma} &= 0, \quad \mathcal{W}^{2,2}(y', \tau) \Big|_{\partial \sigma} = 0, \quad \mathcal{W}^{3,2}(y', \tau) \Big|_{\partial \sigma} = 0, \\ \mathcal{V}^2(y', 0) &= 0, \quad \mathcal{W}^{2,2}(y', 0) = 0, \quad \mathcal{W}^{3,2}(y', 0) = 0, \\ \int_{\sigma} \mathcal{V}^2(y', \tau) dy' &= \sum_{j=0}^J \epsilon^{j+2} \mathcal{H}_j(\tau). \end{aligned}$$

An asymptotic solution for  $(\mathcal{V}^2(y', \tau), \mathcal{W}^{2,2}(y', \tau), \mathcal{W}^{3,2}(y', \tau), \mathcal{S}(\tau))$  is sought in the form given with (3.39).

The zero-order approximation  $(\mathcal{V}_0^2(y', \tau), \mathcal{W}_0^{2,2}(y', \tau), \mathcal{W}_0^{3,2}(y', \tau), \mathcal{S}_0(\tau))$  is the solution of the following system:

$$\begin{aligned} \frac{\partial \mathcal{V}_0^2(y', \tau)}{\partial \tau} - \mu \Delta_{y'} \mathcal{V}_0^2(y', \tau) &= \mathcal{S}_0(\tau), \\ \frac{\partial \mathcal{W}_0^{2,2}(y', \tau)}{\partial \tau} - \alpha \Delta_{y'} \mathcal{W}_0^{2,2}(y', \tau) - \beta \frac{\partial}{\partial y_2} \left( \frac{\partial \mathcal{W}_0^{2,2}(y', \tau)}{\partial y_2} + \frac{\partial \mathcal{W}_0^{3,2}(y', \tau)}{\partial y_3} \right) &= 0, \\ \frac{\partial \mathcal{W}_0^{3,2}(y', \tau)}{\partial \tau} - \alpha \Delta_{y'} \mathcal{W}_0^{3,2}(y', \tau) - \beta \frac{\partial}{\partial y_3} \left( \frac{\partial \mathcal{W}_0^{2,2}(y', \tau)}{\partial y_2} + \frac{\partial \mathcal{W}_0^{3,2}(y', \tau)}{\partial y_3} \right) &= 0, \\ \mathcal{V}_0^2(y', \tau) \Big|_{\partial \sigma} &= 0, \quad \mathcal{W}_0^{2,2}(y', \tau) \Big|_{\partial \sigma} = 0, \quad \mathcal{W}_0^{3,2}(y', \tau) \Big|_{\partial \sigma} = 0, \\ \mathcal{V}_0^2(y', 0) &= -\tilde{V}_0^2(y', 0), \quad \mathcal{W}_0^{2,2}(y', 0) = -\tilde{W}_0^{2,2}(y', 0), \quad \mathcal{W}_0^{3,2}(y', 0) = -\tilde{W}_0^{3,2}(y', 0), \\ \int_{\sigma} \mathcal{V}_0^2(y', \tau) dy' &= \mathcal{H}_0(\tau). \end{aligned}$$

The first-order corrector  $(\mathcal{V}_1^2(y', \tau), \mathcal{W}_1^{2,2}(y', \tau), \mathcal{W}_1^{3,2}(y', \tau), \mathcal{S}_1(\tau))$  is given by:

$$\begin{aligned} \frac{\partial \mathcal{V}_1^2(y', \tau)}{\partial \tau} - \mu \Delta_{y'} \mathcal{V}_1^2(y', \tau) &= a \left( \frac{\partial \mathcal{W}_0^{3,2}(y', \tau)}{\partial y_2} - \frac{\partial \mathcal{W}_0^{2,2}(y', \tau)}{\partial y_3} \right) + \mathcal{S}_1(\tau), \\ \frac{\partial \mathcal{W}_1^{2,2}(y', \tau)}{\partial \tau} - \alpha \Delta_{y'} \mathcal{W}_1^{2,2}(y', \tau) - \beta \frac{\partial}{\partial y_2} \left( \frac{\partial \mathcal{W}_1^{2,2}(y', \tau)}{\partial y_2} + \frac{\partial \mathcal{W}_1^{3,2}(y', \tau)}{\partial y_3} \right) &= a \frac{\partial \mathcal{V}_0^2(y', \tau)}{\partial y_3}, \\ \frac{\partial \mathcal{W}_1^{3,2}(y', \tau)}{\partial \tau} - \alpha \Delta_{y'} \mathcal{W}_1^{3,2}(y', \tau) - \beta \frac{\partial}{\partial y_3} \left( \frac{\partial \mathcal{W}_1^{2,2}(y', \tau)}{\partial y_2} + \frac{\partial \mathcal{W}_1^{3,2}(y', \tau)}{\partial y_3} \right) &= -a \frac{\partial \mathcal{V}_0^2(y', \tau)}{\partial y_2}, \\ \mathcal{V}_1^2(y', \tau) \Big|_{\partial \sigma} &= 0, \quad \mathcal{W}_1^{2,2}(y', \tau) \Big|_{\partial \sigma} = 0, \quad \mathcal{W}_1^{3,2}(y', \tau) \Big|_{\partial \sigma} = 0, \\ \mathcal{V}_1^2(y', 0) &= -\tilde{V}_1^2(y', 0), \quad \mathcal{W}_1^{2,2}(y', 0) = -\tilde{W}_1^{2,2}(y', 0), \quad \mathcal{W}_1^{3,2}(y', 0) = -\tilde{W}_1^{3,2}(y', 0), \\ \int_{\sigma} \mathcal{V}_1^2(y', \tau) dy' &= \mathcal{H}_1(\tau). \end{aligned}$$

Finally, the higher-order correctors  $(\mathcal{V}_j^1(y', \tau), \mathcal{W}_j^{2,2}(y', \tau), \mathcal{W}_j^{3,2}(y', \tau), \mathcal{S}_j(\tau))$  ( $j = 2, \dots, J$ ) obey the following system of equations:

$$\begin{aligned} \frac{\partial \mathcal{V}_j^2(y', \tau)}{\partial \tau} - \mu \Delta_{y'} \mathcal{V}_j^2(y', \tau) &= a \left( \frac{\partial \mathcal{W}_{j-1}^{3,2}(y', \tau)}{\partial y_2} - \frac{\partial \mathcal{W}_{j-1}^{2,2}(y', \tau)}{\partial y_3} \right) + \mathcal{S}_j(\tau), \\ \frac{\partial \mathcal{W}_j^{2,2}(y', \tau)}{\partial \tau} - \alpha \Delta_{y'} \mathcal{W}_j^{2,2}(y', \tau) - \beta \frac{\partial}{\partial y_2} \left( \frac{\partial \mathcal{W}_j^{2,2}(y', \tau)}{\partial y_2} + \frac{\partial \mathcal{W}_j^{3,2}(y', \tau)}{\partial y_3} \right) &= a \frac{\partial \mathcal{V}_{j-1}^2(y', \tau)}{\partial y_3} - 2a \mathcal{W}_{j-2}^{2,2}(y', \tau), \\ \frac{\partial \mathcal{W}_j^{3,2}(y', \tau)}{\partial \tau} - \alpha \Delta_{y'} \mathcal{W}_j^{3,2}(y', \tau) - \beta \frac{\partial}{\partial y_3} \left( \frac{\partial \mathcal{W}_j^{2,2}(y', \tau)}{\partial y_2} + \frac{\partial \mathcal{W}_j^{3,2}(y', \tau)}{\partial y_3} \right) &= -a \frac{\partial \mathcal{V}_{j-1}^2(y', \tau)}{\partial y_2} - 2a \mathcal{W}_{j-2}^{3,2}(y', \tau), \\ \mathcal{V}_j^2(y', \tau) \Big|_{\partial \sigma} &= 0, \quad \mathcal{W}_j^{2,2}(y', \tau) \Big|_{\partial \sigma} = 0, \quad \mathcal{W}_j^{3,2}(y', \tau) \Big|_{\partial \sigma} = 0, \\ \mathcal{V}_j^2(y', 0) &= -\tilde{V}_j^2(y', 0), \quad \mathcal{W}_j^{2,2}(y', 0) = -\tilde{W}_j^{2,2}(y', 0), \quad \mathcal{W}_j^{3,2}(y', 0) = -\tilde{W}_j^{3,2}(y', 0), \\ \int_{\sigma} \mathcal{V}_j^2(y', \tau) dy' &= \mathcal{H}_j(\tau). \end{aligned}$$

The compatibility condition

$$\mathcal{H}_j(0) = - \int_{\sigma} \tilde{V}_j^0(y', 0) dy' \tag{3.48}$$

is necessary to be satisfied to assure the solvability of the above problems.

We can study the existence, uniqueness and exponential decay as  $\tau \rightarrow \infty$  for the velocity/pressure and microrotation separately. In view of that, we introduce the space of functions  $\mathcal{W}_{\nu}^{1,2}(\langle 0, \infty \rangle)$  with the finite norm:

$$\|F\|_{\mathcal{W}_{\nu}^{1,2}(\langle 0, \infty \rangle)} = \left( \int_0^{\infty} \exp(2\nu t) |F(t)|^2 dt + \int_0^{\infty} \exp(2\nu t) |F'(t)|^2 dt \right)^{1/2}.$$

**Theorem 3.10.** (Existence, uniqueness and exponential decay as  $\tau \rightarrow \infty$  – MIP velocity/pressure boundary layer)

Let  $\tilde{V}_j^2(y', 0) \in W_0^{1,2}(\sigma)$ ,  $\mathcal{H}_j \in W^{1,2}(\langle 0, \infty \rangle)$  and  $h_j \in L^2(0, \infty; L^2(\sigma))$  ( $j = 0, 1, \dots, J$ ) be the functions exponentially decaying to zero as  $\tau \rightarrow \infty$ . Let there also hold the compatibility condition

$$\mathcal{H}_j(0) = - \int_{\sigma} \tilde{V}_j^2(y', 0) dy'.$$

Then there exists a unique weak solution  $(\mathcal{V}_j^2, \mathcal{S}^j) \in (L^2(0, \infty; W_0^{1,2}(\sigma)) \cap W^{1,2}(0, \infty; L^2(\sigma))) \times L^2(\langle 0, \infty \rangle)$  of the following problem:

$$\begin{aligned} \frac{\partial \mathcal{V}_j^2(y', \tau)}{\partial \tau} - \mu \Delta_{y'} \mathcal{V}_j^2(y', \tau) &= \mathcal{S}_j(\tau) + h_j(y', \tau), \\ \mathcal{V}_j^2(y', \tau)|_{\partial \sigma} &= 0, \quad \mathcal{V}_j^2(y', 0) = -\tilde{V}_j^2(y', 0), \\ \int_{\sigma} \mathcal{V}_j^2(y', \tau) dy' &= \mathcal{H}_j(\tau), \end{aligned} \quad (3.49)$$

satisfying for all  $t \in [0, \infty)$  the integral identity:

$$\begin{aligned} & \int_0^t \int_{\sigma} \frac{\partial \mathcal{V}_j^2}{\partial \tau} \eta \, dy' d\tau + \mu \int_0^t \int_{\sigma} \nabla_{y'} \mathcal{V}_j^2 \cdot \nabla_{y'} \eta \, dy' d\tau \\ &= \int_0^t \mathcal{S}_j(\tau) \int_{\sigma} \eta \, dy' d\tau + \int_0^t \int_{\sigma} h_j \eta \, dy' d\tau, \quad \forall \eta \in L^2(0, \infty; W_0^{1,2}(\sigma)). \end{aligned}$$

Moreover, there holds the estimate:

$$\begin{aligned} & \|\mathcal{V}_j^2\|_{L^\infty(0, \infty; W^{1,2}(\sigma))} + \|\mathcal{V}_j^2\|_{L^2(0, \infty; W^{1,2}(\sigma))} + \left\| \frac{\partial \mathcal{V}_j^2}{\partial \tau} \right\|_{L^2(0, \infty; L^2(\sigma))} + \|\mathcal{S}_j\|_{L^2(\langle 0, \infty \rangle)} \\ & \leq c(\|\mathcal{H}_j\|_{W^{1,2}(\langle 0, \infty \rangle)} + \|\tilde{V}_j^2(\cdot, 0)\|_{W^{1,2}(\sigma)} + \|h_j\|_{L^2(0, \infty; L^2(\sigma))}). \end{aligned}$$

If  $\mathcal{H}^j \in \mathcal{W}_{\delta_*}^{1,2}(\langle 0, \infty \rangle)$ , there also holds the following estimate:

$$\begin{aligned} & \max_{\tau \in [0, \infty)} \left[ \exp\left(\frac{\gamma_*}{2}\tau\right) \left( \int_{\sigma} |\mathcal{V}_j^2(y', \tau)|^2 + \mu \int_{\sigma} |\nabla_{y'} \mathcal{V}_j^2(y', \tau)|^2 dy' \right) \right] \\ & + \int_0^\infty \exp\left(\frac{\gamma_*}{2}\tau\right) \int_{\sigma} \left( \left| \frac{\partial \mathcal{V}_j^2(y', \tau)}{\partial \tau} \right|^2 + |\mathcal{V}_j^2(y', \tau)|^2 + |\nabla_{y'} \mathcal{V}_j^2(y', \tau)|^2 + |\mathcal{S}_j(\tau)|^2 \right) dy' d\tau \\ & \leq c(\|\mathcal{H}_j(\tau)\|_{\mathcal{W}_{\delta_*}^{1,2}(\langle 0, \infty \rangle)}^2 + \|\tilde{V}_j^2(y', 0)\|_{W^{1,2}(\sigma)}^2 + \|\exp(\delta_*\tau)h_j(y', \tau)\|_{L^2(0, \infty; L^2(\sigma))}^2), \end{aligned} \quad (3.50)$$

where  $\gamma_* = \min\{\lambda_1, 1, \mu\}$ ,  $\delta_* = \frac{\gamma_*}{4}$  and  $\lambda_1$  is the first eigenvalue of the problem (3.29).

*Proof.* The existence and uniqueness of the solution of the problem (3.49) is established in [33, Chapter II, Section 2.2.4., Theorem 2.7].

The proof of the exponential decay as  $\tau \rightarrow \infty$  of the solution follows by extending the result from [33, Chapter II, Section 2.4, Theorem 2.12] for  $h_j \neq 0$ .

We provide details in the sequel.

**Step 1.** We multiply (3.49)<sub>1</sub> by  $\mathcal{V}_j^2$ , integrate by parts in  $\sigma$  to get:

$$\begin{aligned} & \frac{d}{d\tau} \int_{\sigma} |\mathcal{V}_j^2(y', \tau)|^2 dy' + 2\mu \int_{\sigma} |\nabla_{y'} \mathcal{V}_j^2(y', \tau)|^2 dy' \\ &= 2\mathcal{S}_j(\tau) \int_{\sigma} \mathcal{V}_j^2(y', \tau) dy' + 2 \int_{\sigma} h_j(y', \tau) \mathcal{V}_j^2(y', \tau) dy'. \end{aligned}$$

Using Young's inequality in the first and second term on the right hand side of the above equation, we have:

$$\begin{aligned} & \frac{d}{d\tau} \int_{\sigma} |\mathcal{V}_j^2(y', \tau)|^2 dy' + 2\mu \int_{\sigma} |\nabla_{y'} \mathcal{V}_j^2(y', \tau)|^2 dy' \\ &\leq \delta_1 |\mathcal{S}_j(\tau)|^2 + \frac{1}{\delta_1} |\mathcal{H}_j(\tau)|^2 + \delta_2 \int_{\sigma} |h_j(y', \tau)|^2 dy' + \frac{1}{\delta_2} \int_{\sigma} |\mathcal{V}_j^2(y', \tau)|^2 dy'. \end{aligned}$$

Using the Poincaré inequality (3.30) and fixing  $\delta_2 = \frac{1}{\lambda_1}$ , we have:

$$\begin{aligned} & \frac{d}{d\tau} \int_{\sigma} |\mathcal{V}_j^2(y', \tau)|^2 dy' + \mu \int_{\sigma} |\nabla_{y'} \mathcal{V}_j^2(y', \tau)|^2 dy' \\ &\leq \delta_1 |\mathcal{S}_j(\tau)|^2 + \frac{1}{\delta_1} |\mathcal{H}_j(\tau)|^2 + \frac{1}{\lambda_1} \int_{\sigma} |h_j(y', \tau)|^2 dy'. \end{aligned} \tag{3.51}$$

**Step 2.** We now multiply (3.49)<sub>1</sub> by  $\frac{\partial \mathcal{V}_j^2(y', \tau)}{\partial \tau}$  and integrate by parts in  $\sigma$  to get the following relation:

$$\begin{aligned} & \int_{\sigma} \left| \frac{\partial \mathcal{V}_j^2(y', \tau)}{\partial \tau} \right|^2 dy' + \frac{\mu}{2} \frac{d}{d\tau} \int_{\sigma} |\nabla_{y'} \mathcal{V}_j^2(y', \tau)|^2 dy' \\ &= \mathcal{S}_j(\tau) \int_{\sigma} \frac{\partial \mathcal{V}_j^2(y', \tau)}{\partial \tau} dy' + \int_{\sigma} h_j(y', \tau) \frac{\partial \mathcal{V}_j^2(y', \tau)}{\partial \tau} dy'. \end{aligned} \tag{3.52}$$

Again, using Young's inequality on the right-hand side of the equation (3.52) yields

$$\begin{aligned} & 2 \int_{\sigma} \left| \frac{\partial \mathcal{V}_j^2(y', \tau)}{\partial \tau} \right|^2 dy' + \mu \frac{d}{d\tau} \int_{\sigma} |\nabla_{y'} \mathcal{V}_j^2(y', \tau)|^2 dy' \\ &\leq \delta_1 |\mathcal{S}_j(\tau)|^2 + \frac{1}{\delta_1} |(\mathcal{H}_j(\tau))'|^2 + \delta_3 \int_{\sigma} |h_j(y', \tau)|^2 dy' + \frac{1}{\delta_3} \int_{\sigma} \left| \frac{\partial \mathcal{V}_j^2(y', \tau)}{\partial \tau} \right|^2 dy'. \end{aligned}$$

Fixing  $\delta_3 = 1$ , we now have

$$\begin{aligned} & \int_{\sigma} \left| \frac{\partial \mathcal{V}_j^2(y', \tau)}{\partial \tau} \right|^2 dy' + \mu \frac{d}{d\tau} \int_{\sigma} |\nabla_{y'} \mathcal{V}_j^2(y', \tau)|^2 dy' \\ &\leq \delta_1 |\mathcal{S}_j(\tau)|^2 + \frac{1}{\delta_1} |(\mathcal{H}_j(\tau))'|^2 + \int_{\sigma} |h_j(y', \tau)|^2 dy'. \end{aligned} \tag{3.53}$$

**Step 3.** Let  $U^0$  be the solution of

$$\begin{aligned} -\mu\Delta_{y'}U^0(y') &= 1, \quad y' \in \sigma, \\ U^0(y') &= 0, \quad y' \in \partial\sigma. \end{aligned}$$

We now multiply (3.49)<sub>1</sub> by  $U^0(y')$  and integrate by parts in  $\sigma$  to get

$$\begin{aligned} \int_{\sigma} \frac{\partial \mathcal{V}_j^2(y', \tau)}{\partial \tau} U^0(y') dy' - \mu \int_{\sigma} \mathcal{V}_j^2(y', \tau) \Delta_{y'} U^0(y') dy' \\ = \mathcal{S}_j(\tau) \int_{\sigma} U^0(y') dy' + \int_{\sigma} h_j(y', \tau) U^0(y') dy'. \end{aligned}$$

We have

$$\left| \mathcal{S}_j(\tau) \int_{\sigma} U^0(y') dy' \right| = \left| \left( \int_{\sigma} \left( \frac{\partial \mathcal{V}_j^2(y', \tau)}{\partial \tau} - h_j(y', \tau) \right) U^0(y') dy' - \mu \int_{\sigma} \mathcal{V}_j^2(y', \tau) \Delta_{y'} U^0(y') dy' \right) \right|. \quad (3.54)$$

Using the Cauchy–Schwarz and Poincaré inequalities, from (3.54) we deduce:

$$\begin{aligned} \kappa_0^2 |\mathcal{S}_j(\tau)|^2 &\leq 2 \left( \int_{\sigma} \left( \frac{\partial \mathcal{V}_j^2(y', \tau)}{\partial \tau} - h_j(y', \tau) \right) U^0(y') dy' \right)^2 + 2 \left( \int_{\sigma} |\mathcal{V}_j^2(y', \tau)| dy' \right)^2 \\ &\leq \frac{2\mu}{\lambda_1} \left( \int_{\sigma} \left| \frac{\partial \mathcal{V}_j^2(y', \tau)}{\partial \tau} - h_j(y', \tau) \right|^2 dy' \right) \left( \int_{\sigma} |\nabla_{y'} U^0(y')|^2 dy' \right) + 2 |\mathcal{H}_j(\tau)|^2 \\ &\leq \frac{4\kappa_0}{\lambda_1} \left( \int_{\sigma} \left| \frac{\partial \mathcal{V}_j^2(y', \tau)}{\partial \tau} \right|^2 dy' + \int_{\sigma} |h_j(y', \tau)|^2 dy' \right) + 2 |\mathcal{H}_j(\tau)|^2, \end{aligned} \quad (3.55)$$

where we denote  $\kappa_0 = \int_{\sigma} U^0(y') dy' = \mu \int_{\sigma} |\nabla_{y'} U^0(y')|^2 dy'$ .

**Step 4.** From inequalities (3.51) and (3.53) we now have:

$$\begin{aligned} &\frac{d}{d\tau} \int_{\sigma} |\mathcal{V}_j^2(y', \tau)|^2 dy' + \mu \int_{\sigma} |\nabla_{y'} \mathcal{V}_j^2(y', \tau)|^2 dy' \\ &+ \int_{\sigma} \left| \frac{\partial \mathcal{V}_j^2(y', \tau)}{\partial \tau} \right|^2 dy' + \mu \frac{d}{d\tau} \int_{\sigma} |\nabla_{y'} \mathcal{V}_j^2(y', \tau)|^2 dy' \\ &\leq 2\delta_1 |\mathcal{S}_j(\tau)|^2 + \frac{1}{\delta_1} (|\mathcal{H}_j(\tau)|^2 + |(\mathcal{H}_j(\tau))'|^2) + \frac{\lambda_1 + 1}{\lambda_1} \int_{\sigma} |h_j(y', \tau)|^2 dy'. \end{aligned}$$

Plugging (3.55) into the above equation, we get:

$$\begin{aligned} &\frac{d}{d\tau} \left( \int_{\sigma} |\mathcal{V}_j^2(y', \tau)|^2 dy' + \mu \int_{\sigma} |\nabla_{y'} \mathcal{V}_j^2(y', \tau)|^2 dy' \right) + \mu \int_{\sigma} |\nabla_{y'} \mathcal{V}_j^2(y', \tau)|^2 dy' \\ &+ \int_{\sigma} \left| \frac{\partial \mathcal{V}_j^2(y', \tau)}{\partial \tau} \right|^2 dy' \leq \frac{8}{\lambda_1 \kappa_0} \delta_1 \left( \int_{\sigma} \left| \frac{\partial \mathcal{V}_j^2(y', \tau)}{\partial \tau} \right|^2 dy' + \int_{\sigma} |h_j(y', \tau)|^2 dy' \right) \\ &+ c (|\mathcal{H}_j(\tau)|^2 + |(\mathcal{H}_j(\tau))'|^2 + \int_{\sigma} |h_j(y', \tau)|^2 dy'). \end{aligned}$$

Fixing  $\delta_1 = \frac{\lambda_1 \kappa_0}{16}$ , we have:

$$\begin{aligned}
 & \frac{d}{d\tau} \left( \int_{\sigma} |\mathcal{V}_j^2(y', \tau)|^2 dy' + \mu \int_{\sigma} |\nabla_{y'} \mathcal{V}_j^2(y', \tau)|^2 dy' \right) \\
 & + \mu \int_{\sigma} |\nabla_{y'} \mathcal{V}_j^2(y', \tau)|^2 dy' + \frac{1}{2} \int_{\sigma} \left| \frac{\partial \mathcal{V}_j^2(y', \tau)}{\partial \tau} \right|^2 dy' \\
 & \leq c(|\mathcal{H}_j(\tau)|^2 + |(\mathcal{H}_j(\tau))'|^2 + \int_{\sigma} |h_j(y', \tau)|^2 dy').
 \end{aligned} \tag{3.56}$$

Applying the Poincaré inequality to equation (3.56), we get:

$$\begin{aligned}
 & \frac{d}{d\tau} \left( \int_{\sigma} |\mathcal{V}_j^2(y', \tau)|^2 dy' + \mu \int_{\sigma} |\nabla_{y'} \mathcal{V}_j^2(y', \tau)|^2 dy' \right) \\
 & + \gamma_* \left( \int_{\sigma} |\mathcal{V}_j^2(y', \tau)|^2 + \mu \int_{\sigma} |\nabla_{y'} \mathcal{V}_j^2(y', \tau)|^2 dy' \right) + \frac{1}{2} \int_{\sigma} \left| \frac{\partial \mathcal{V}_j^2(y', \tau)}{\partial \tau} \right|^2 dy' \\
 & \leq c(|\mathcal{H}_j(\tau)|^2 + |(\mathcal{H}_j(\tau))'|^2 + \int_{\sigma} |h_j(y', \tau)|^2 dy'),
 \end{aligned} \tag{3.57}$$

where  $\gamma_* = \min\{\lambda_1, 1, \mu\}$ .

**Step 5.** Multiplying equation (3.57) by  $\exp(\frac{\gamma_*}{2}\tau)$  and integrating over  $\tau$  we have

$$\begin{aligned}
 & \exp\left(\frac{\gamma_*}{2}\tau\right) \left( \int_{\sigma} |\mathcal{V}_j^2(y', \tau)|^2 dy' + \mu \int_{\sigma} |\nabla_{y'} \mathcal{V}_j^2(y', \tau)|^2 dy' \right) \\
 & + \int_0^{\tau} \exp\left(\frac{\gamma_*}{2}t\right) \int_{\sigma} \left( \left| \frac{\partial \mathcal{V}_j^2(y', t)}{\partial t} \right|^2 + |\mathcal{V}_j^2(y', t)|^2 + |\nabla_{y'} \mathcal{V}_j^2(y', t)|^2 \right) dy' dt \\
 & \leq c \left( \int_0^{\tau} \exp\left(\frac{\gamma_*}{2}t\right) (|\mathcal{H}_j(t)|^2 + |(\mathcal{H}_j(t))'|^2) dt \right) \\
 & + c \left( \|\tilde{A}_j(y')\|_{W_2^1(\sigma)}^2 + \int_0^{\tau} \exp\left(\frac{\gamma_*}{2}t\right) \int_{\sigma} |h_j(y', t)|^2 dy' dt \right),
 \end{aligned} \tag{3.58}$$

where  $\delta_* = \gamma_*/4$ . Estimate (3.55) now yields:

$$\begin{aligned}
 \int_0^{\tau} \exp\left(\frac{\gamma_*}{2}t\right) |\mathcal{S}_j(t)|^2 dt & \leq c \left( \int_0^{\tau} \exp\left(\frac{\gamma_*}{2}t\right) (|\mathcal{H}_j(t)|^2 + |(\mathcal{H}_j(t))'|^2) dt \right) \\
 & + c \left( \|\tilde{A}_j(y')\|_{W_2^1(\sigma)}^2 + \int_0^{\tau} \int_{\sigma} \exp\left(\frac{\gamma_*}{2}t\right) |h_j(y', t)|^2 dy' dt \right).
 \end{aligned} \tag{3.59}$$

**Step 6.** Finally, taking the maximum over time in (3.58) and (3.59), we get the estimate

$$\begin{aligned}
 & \max_{\tau \in [0, \infty)} \left[ \exp\left(\frac{\gamma_*}{2}\tau\right) \left( \int_{\sigma} |\mathcal{V}_j^2(y', \tau)|^2 dy' + \mu \int_{\sigma} |\nabla_{y'} \mathcal{V}_j^2(y', \tau)|^2 dy' \right) \right] \\
 & + \int_0^{\infty} \exp\left(\frac{\gamma_*}{2}\tau\right) \int_{\sigma} \left( \left| \frac{\partial \mathcal{V}_j^2(y', \tau)}{\partial \tau} \right|^2 + |\mathcal{V}_j^2(y', \tau)|^2 + |\nabla_{y'} \mathcal{V}_j^2(y', \tau)|^2 + |\mathcal{S}_j(\tau)|^2 \right) dy' d\tau \\
 & \leq c \left( \|\mathcal{H}_j(\tau)\|_{W_{\delta_*}^{1,2}((0, \infty))}^2 + \|\tilde{A}_j(y')\|_{W^{1,2}(\sigma)}^2 + \|\exp(\delta_*\tau) h_j(y', \tau)\|_{L^2(0, \infty; L^2(\sigma))}^2 \right),
 \end{aligned}$$

thus obtaining the estimate (3.50). □

The corresponding results for the microrotation boundary–layer correctors are formulated in Theorem 3.5 and Theorem 3.7.

### 3.4 Rigorous Justification of the Model

Collecting the asymptotic expansions constructed for the micropolar heat and micropolar inverse problem given with (3.17)–(3.18) and (3.38)–(3.39), we obtain:

$$\begin{aligned}
 V_{\epsilon,[J]}^1(x', t) &= \sum_{j=0}^J \epsilon^{j+2} \left( \tilde{V}_j^1 \left( \frac{x'}{\epsilon}, t \right) + \mathcal{V}_j^1 \left( \frac{x'}{\epsilon}, \frac{t}{\epsilon^2} \right) \right), \\
 V_{\epsilon,[J]}^2(x', t) &= \sum_{j=0}^J \epsilon^{j+2} \left( \tilde{V}_j^2 \left( \frac{x'}{\epsilon}, t \right) + \mathcal{V}_j^2 \left( \frac{x'}{\epsilon}, \frac{t}{\epsilon^2} \right) \right), \\
 W_{\epsilon,[J]}^{2,1}(x', t) &= \sum_{j=0}^J \epsilon^{j+2} \left( \tilde{W}_j^{2,1} \left( \frac{x'}{\epsilon}, t \right) + \mathcal{W}_j^{2,1} \left( \frac{x'}{\epsilon}, \frac{t}{\epsilon^2} \right) \right), \\
 W_{\epsilon,[J]}^{3,1}(x', t) &= \sum_{j=0}^J \epsilon^{j+2} \left( \tilde{W}_j^{3,1} \left( \frac{x'}{\epsilon}, t \right) + \mathcal{W}_j^{3,1} \left( \frac{x'}{\epsilon}, \frac{t}{\epsilon^2} \right) \right), \\
 W_{\epsilon,[J]}^{2,2}(x', t) &= \sum_{j=0}^J \epsilon^{j+2} \left( \tilde{W}_j^{2,2} \left( \frac{x'}{\epsilon}, t \right) + \mathcal{W}_j^{2,2} \left( \frac{x'}{\epsilon}, \frac{t}{\epsilon^2} \right) \right), \\
 W_{\epsilon,[J]}^{3,2}(x', t) &= \sum_{j=0}^J \epsilon^{j+2} \left( \tilde{W}_j^{3,2} \left( \frac{x'}{\epsilon}, t \right) + \mathcal{W}_j^{3,2} \left( \frac{x'}{\epsilon}, \frac{t}{\epsilon^2} \right) \right), \\
 v_{\epsilon,[J]}(x', t) &= V_{\epsilon,[J]}^1(x', t) + V_{\epsilon,[J]}^2(x', t), \\
 w_{\epsilon,[J]}^2(x', t) &= W_{\epsilon,[J]}^{2,1}(x', t) + W_{\epsilon,[J]}^{2,2}(x', t), \quad w_{\epsilon,[J]}^3(x', t) = W_{\epsilon,[J]}^{3,1}(x', t) + W_{\epsilon,[J]}^{3,2}(x', t), \\
 S_{\epsilon,[J]}(t) &= \sum_{j=0}^J \epsilon^{j+2} \left( s_j(t) + \mathcal{S}_j \left( \frac{t}{\epsilon^2} \right) \right), \quad q_{\epsilon,[J]}(t) = \frac{1}{\epsilon^2} S_{\epsilon,[J]}(t), \\
 \mathbf{u}_{\epsilon,[J]}(x, t) &= (v_{\epsilon,[J]}(x', t), 0, 0), \quad \mathbf{w}_{\epsilon,[J]}(x, t) = (0, w_{\epsilon,[J]}^2(x', t), w_{\epsilon,[J]}^3(x', t)).
 \end{aligned} \tag{3.60}$$

**Lemma 3.11** (Poincaré’s inequality).

Let  $T \in \langle 0, \infty \rangle$  and  $t \in [0, T]$ . There then exists a positive constant  $C > 0$ , independent of  $\epsilon$ , such that there holds:

$$\|\phi(\cdot, t)\|_{L^2(\sigma_\epsilon)^3} \leq C\epsilon \|\nabla \phi(\cdot, t)\|_{L^2(\sigma_\epsilon)^3}, \tag{3.61}$$

za svaki  $\phi(\cdot, t) \in W_0^{1,2}(\sigma_\epsilon)^3$ .

**Theorem 3.12** (Rigorous justification of the asymptotic model).

Let  $\mathbf{u}_{\epsilon,[J]}$ ,  $\mathbf{w}_{\epsilon,[J]}$ ,  $q_{\epsilon,[J]}$  defined with (3.60). There then hold the following estimates:

$$\begin{aligned} \max_{t \in [0, \infty)} \|\mathbf{u}_{\epsilon}(\cdot, t) - \mathbf{u}_{\epsilon,[J]}(\cdot, t)\|_{W^{1,2}(\sigma_{\epsilon})^3} + \|\mathbf{u}_{\epsilon} - \mathbf{u}_{\epsilon,[J]}\|_{L^2(0, \infty; W^{1,2}(\sigma_{\epsilon})^3)} \\ + \left\| \frac{\partial(\mathbf{u}_{\epsilon} - \mathbf{u}_{\epsilon,[J]})}{\partial t} \right\|_{L^2(0, \infty; L^2(\sigma_{\epsilon})^3)} = \mathcal{O}(\epsilon^{J+2}), \end{aligned} \quad (3.62)$$

$$\begin{aligned} \max_{t \in [0, \infty)} \|\mathbf{w}_{\epsilon}(\cdot, t) - \mathbf{w}_{\epsilon,[J]}(\cdot, t)\|_{W^{1,2}(\sigma_{\epsilon})^3} + \|\mathbf{w}_{\epsilon} - \mathbf{w}_{\epsilon,[J]}\|_{L^2(0, \infty; W^{1,2}(\sigma_{\epsilon})^3)} \\ + \left\| \frac{\partial(\mathbf{w}_{\epsilon} - \mathbf{w}_{\epsilon,[J]})}{\partial t} \right\|_{L^2(0, \infty; L^2(\sigma_{\epsilon})^3)} = \mathcal{O}(\epsilon^{J+2}), \end{aligned} \quad (3.63)$$

$$\|q - q_{\epsilon,[J]}\|_{L^2((0, \infty))} = \mathcal{O}(\epsilon^{J+2}). \quad (3.64)$$

*Proof.* The function  $\mathbf{w}_{\epsilon,[J]}$  satisfies the following estimate:

$$\frac{\partial \mathbf{w}_{\epsilon,[J]}}{\partial t} - \alpha \Delta_{x'} \mathbf{w}_{\epsilon,[J]} - \beta \nabla_{x'} \operatorname{div} \mathbf{w}_{\epsilon,[J]} + 2a \mathbf{w}_{\epsilon,[J]} = a \operatorname{rot} \mathbf{u}_{\epsilon,[J-1]} + \mathbf{g}_{\epsilon} + \mathbf{h}_{\epsilon}, \quad (3.65)$$

where  $\|\mathbf{h}_{\epsilon}\|_{L^2(0, \infty; L^{\infty}(\sigma_{\epsilon})^3)} = \mathcal{O}(\epsilon^{J+1})$ , that is,  $\|\mathbf{h}_{\epsilon}\|_{L^2(0, \infty; L^2(\sigma_{\epsilon})^3)} = \mathcal{O}(\epsilon^{J+2})$ . We introduce

$$\mathbf{s}_{\epsilon} = \mathbf{w}_{\epsilon} - \mathbf{w}_{\epsilon,[J]},$$

as the difference between the original solution and our asymptotic approximation.

Subtracting equations (3.6)<sub>2,3</sub> and (3.65) yields

$$\frac{\partial \mathbf{s}_{\epsilon}}{\partial t} - \alpha \Delta_{x'} \mathbf{s}_{\epsilon} - \beta \nabla_{x'} \operatorname{div} \mathbf{s}_{\epsilon} + 2a \mathbf{s}_{\epsilon} = a \operatorname{rot}(\mathbf{u}_{\epsilon} - \mathbf{u}_{\epsilon,[J-1]}) - \mathbf{h}_{\epsilon} \text{ in } \sigma_{\epsilon}. \quad (3.66)$$

Multiplying equations (3.66) with  $\mathbf{s}_{\epsilon}$  and integrating over  $\sigma_{\epsilon}$ , we have:

$$\frac{1}{2} \frac{d}{dt} \int_{\sigma} |\mathbf{s}_{\epsilon}|^2 + \alpha \int_{\sigma} |\nabla_{x'} \mathbf{s}_{\epsilon}|^2 + \beta \int_{\sigma} (\operatorname{div} \mathbf{s}_{\epsilon})^2 + 2a \int_{\sigma} |\mathbf{s}_{\epsilon}|^2 = a \int_{\sigma} \operatorname{rot}(\mathbf{u}_{\epsilon} - \mathbf{u}_{\epsilon,[J-1]}) \mathbf{s}_{\epsilon} - \int_{\sigma} \mathbf{h}_{\epsilon} \mathbf{s}_{\epsilon}. \quad (3.67)$$

Estimating each term on the right-hand side of (3.67) using Poincaré's inequality (3.61), we obtain:

$$\begin{aligned} \left| \int_{\sigma_{\epsilon}} \operatorname{rot}(\mathbf{u}_{\epsilon} - \mathbf{u}_{\epsilon,[J-1]}) \mathbf{s}_{\epsilon} \right| &\leq C \|\nabla_{x'}(\mathbf{u}_{\epsilon} - \mathbf{u}_{\epsilon,[J-1]})\|_{L^2(\sigma_{\epsilon})^3} \|\mathbf{s}_{\epsilon}\|_{L^2(\sigma_{\epsilon})^3} \\ &\leq C \|\nabla_{x'}(\mathbf{u}_{\epsilon} - \mathbf{u}_{\epsilon,[J]})\|_{L^2(\sigma_{\epsilon})^3} \|\mathbf{s}_{\epsilon}\|_{L^2(\sigma_{\epsilon})^3} \\ &\quad + C \|\nabla_{x'}(\mathbf{u}_{\epsilon,[J]} - \mathbf{u}_{\epsilon,[J-1]})\|_{L^2(\sigma_{\epsilon})^3} \|\mathbf{s}_{\epsilon}\|_{L^2(\sigma_{\epsilon})^3} \\ &\leq C \epsilon \|\nabla_{x'}(\mathbf{u}_{\epsilon} - \mathbf{u}_{\epsilon,[J]})\|_{L^2(\sigma_{\epsilon})^3} \|\nabla_{x'} \mathbf{s}_{\epsilon}\|_{L^2(\sigma_{\epsilon})^3} \\ &\quad + C \epsilon^{J+3} \|\nabla_{x'} \mathbf{u}_J\|_{L^2(\sigma_{\epsilon})^3} \|\nabla_{x'} \mathbf{s}_{\epsilon}\|_{L^2(\sigma_{\epsilon})^3}, \\ \left| \int_{\sigma_{\epsilon}} \mathbf{h}_{\epsilon} \mathbf{s}_{\epsilon} \right| &\leq \|\mathbf{h}_{\epsilon}\|_{L^2(\sigma_{\epsilon})^3} \|\mathbf{s}_{\epsilon}\|_{L^2(\sigma_{\epsilon})^3} \leq C \epsilon \|\mathbf{h}_{\epsilon}\|_{L^2(\sigma_{\epsilon})^3} \|\nabla_{x'} \mathbf{s}_{\epsilon}\|_{L^2(\sigma_{\epsilon})^3}, \end{aligned} \quad (3.68)$$



where  $\mathbf{u}_J = \frac{1}{\epsilon^{J+2}}(\mathbf{u}_{\epsilon,[J]} - \mathbf{u}_{\epsilon,[J-1]})$ .

Taking into account estimates (3.68), from (3.67) we get:

$$\begin{aligned} \frac{1}{2} \frac{d}{dt} \|\mathbf{s}_\epsilon\|_{L^2(\sigma_\epsilon)^3}^2 + \alpha \|\nabla_{x'} \mathbf{s}_\epsilon\|_{L^2(\sigma_\epsilon)^3}^2 &\leq C\epsilon \|\nabla_{x'}(\mathbf{u}_\epsilon - \mathbf{u}_{\epsilon,[J]})\|_{L^2(\sigma_\epsilon)^3} \|\nabla_{x'} \mathbf{s}_\epsilon\|_{L^2(\sigma_\epsilon)^3} \\ &\quad + C\epsilon^{J+3} \|\nabla_{x'} \mathbf{u}_J\|_{L^2(\sigma_\epsilon)^3} \|\nabla_{x'} \mathbf{s}_\epsilon\|_{L^2(\sigma_\epsilon)^3} \\ &\quad + C\epsilon \|\mathbf{h}_\epsilon\|_{L^2(\sigma_\epsilon)^3} \|\nabla_{x'} \mathbf{s}_\epsilon\|_{L^2(\sigma_\epsilon)^3}. \end{aligned}$$

Applying Young's inequality, we obtain:

$$\begin{aligned} \frac{1}{2} \frac{d}{dt} \|\mathbf{s}_\epsilon\|_{L^2(\sigma_\epsilon)^3}^2 + \alpha \|\nabla_{x'} \mathbf{s}_\epsilon\|_{L^2(\sigma_\epsilon)^3}^2 &\leq \frac{C}{\xi} \left( \epsilon^2 \|\nabla_{x'}(\mathbf{u}_\epsilon - \mathbf{u}_{\epsilon,[J]})\|_{L^2(\sigma_\epsilon)^3}^2 + \epsilon^{2J+6} \|\nabla_{x'} \mathbf{u}_J\|_{L^2(\sigma_\epsilon)^3}^2 \right) \\ &\quad + \frac{C\epsilon^2}{\xi} \|\mathbf{h}_\epsilon\|_{L^2(\sigma_\epsilon)^3}^2 + C\xi \|\nabla_{x'} \mathbf{s}_\epsilon\|_{L^2(\sigma_\epsilon)^3}^2. \end{aligned}$$

Taking  $\xi$  such that  $\alpha - C\xi > 0$ , and integrating over  $t$ , we get:

$$\begin{aligned} \|\mathbf{s}_\epsilon\|_{L^2(\sigma_\epsilon)^3}^2 + \int_0^t \|\nabla_{x'} \mathbf{s}_\epsilon\|_{L^2(\sigma_\epsilon)^3}^2 &\leq C\epsilon^2 \int_0^t \|\nabla_{x'}(\mathbf{u}_\epsilon - \mathbf{u}_{\epsilon,[J]})\|_{L^2(\sigma_\epsilon)^3}^2 \\ &\quad + C \int_0^t \left( \epsilon^2 \|\mathbf{h}_\epsilon\|_{L^2(\sigma_\epsilon)^3}^2 + \epsilon^{2J+6} \|\nabla_{x'} \mathbf{u}_J\|_{L^2(\sigma_\epsilon)^3}^2 \right). \end{aligned} \quad (3.69)$$

Multiplying equation (3.66) with  $\frac{\partial \mathbf{s}_\epsilon}{\partial t}$ , integrating over  $\sigma_\epsilon$  and estimating the right-hand side yields:

$$\begin{aligned} \frac{1}{2} \left\| \frac{\partial \mathbf{s}_\epsilon}{\partial t} \right\|_{L^2(\sigma_\epsilon)^3}^2 + \alpha \frac{d}{dt} \|\nabla_{x'} \mathbf{s}_\epsilon\|_{L^2(\sigma_\epsilon)^3}^2 &\leq C \|\nabla_{x'}(\mathbf{u}_\epsilon - \mathbf{u}_{\epsilon,[J]})\|_{L^2(\sigma_\epsilon)^3} \left\| \frac{\partial \mathbf{s}_\epsilon}{\partial t} \right\|_{L^2(\sigma_\epsilon)^3} \\ &\quad + C \left( \|\mathbf{h}_\epsilon\|_{L^2(\sigma_\epsilon)^3} + \epsilon^{J+2} \|\nabla_{x'} \mathbf{u}_J\|_{L^2(\sigma_\epsilon)^3} \right) \left\| \frac{\partial \mathbf{s}_\epsilon}{\partial t} \right\|_{L^2(\sigma_\epsilon)^3}. \end{aligned}$$

Applying Young's inequality and integrating over  $t$ , we obtain:

$$\begin{aligned} \|\nabla_{x'} \mathbf{s}_\epsilon\|_{L^2(\sigma_\epsilon)^3}^2 + \int_0^t \left\| \frac{\partial \mathbf{s}_\epsilon}{\partial t} \right\|_{L^2(\sigma_\epsilon)^3}^2 &\leq C \int_0^t \left( \|\nabla_{x'}(\mathbf{u}_\epsilon - \mathbf{u}_{\epsilon,[J]})\|_{L^2(\sigma_\epsilon)^3}^2 + \epsilon^{2J+4} \|\nabla_{x'} \mathbf{u}_J\|_{L^2(\sigma_\epsilon)^3}^2 \right) \\ &\quad + C \int_0^t \|\mathbf{h}_\epsilon\|_{L^2(\sigma_\epsilon)^3}^2. \end{aligned} \quad (3.70)$$

Summing the obtained inequalities (3.69) and (3.70) and using Poincaré's inequality, we obtain the estimate:

$$\begin{aligned}
 \|\mathbf{s}_\epsilon\|_{W^{1,2}(\sigma_\epsilon)^3}^2 + \|\mathbf{s}_\epsilon\|_{L^2(0,t;W^{1,2}(\sigma_\epsilon)^3)}^2 + \left\| \frac{\partial \mathbf{s}_\epsilon}{\partial t} \right\|_{L^2(0,t;L^2(\sigma_\epsilon)^3)}^2 &\leq C \int_0^t \|\nabla_{x'}(\mathbf{u}_\epsilon - \mathbf{u}_{\epsilon,[J]})\|_{L^2(\sigma_\epsilon)^3}^2 \\
 &+ C \int_0^t \epsilon^{2J+4} \|\nabla_{x'} \mathbf{u}_J\|_{L^2(\sigma_\epsilon)^3}^2 \\
 &+ C \int_0^t \|\mathbf{h}_\epsilon\|_{L^2(\sigma_\epsilon)^3}^2.
 \end{aligned} \tag{3.71}$$

The problem satisfied by  $(\mathbf{u}_{\epsilon,[J]}, p_{\epsilon,[J]})$  on  $\sigma_\epsilon$  is the following:

$$\begin{aligned}
 \frac{\partial \mathbf{u}_{\epsilon,[J]}}{\partial t} - \mu \Delta_{x'} \mathbf{u}_{\epsilon,[J]} + \nabla p_{\epsilon,[J]} &= \text{arot} \mathbf{w}_{\epsilon,[J-1]} + \mathbf{f}_\epsilon + \mathbf{E}_\epsilon, \\
 \mathbf{u}_{\epsilon,[J]}|_{\partial \sigma_\epsilon} &= 0, \quad \mathbf{u}_{\epsilon,[J]}(x', 0) = (a_\epsilon(x'), 0, 0), \\
 \text{div} \mathbf{u}_{\epsilon,[J]} &= 0, \\
 \int_{\sigma_\epsilon} \mathbf{u}_{\epsilon,[J]} dx' &= F(t),
 \end{aligned}$$

where  $\|\mathbf{E}_\epsilon\|_{L^2(0,\infty;L^2(\sigma_\epsilon)^3)} = \mathcal{O}(\epsilon^{J+2})$ .

Denoting

$$\mathbf{R}_\epsilon = \mathbf{u}_\epsilon - \mathbf{u}_{\epsilon,[J]}, \quad r_\epsilon = p_\epsilon - p_{\epsilon,[J]},$$

we obtain

$$\begin{aligned}
 \frac{\partial \mathbf{R}_\epsilon}{\partial t} - \mu \Delta_{x'} \mathbf{R}_\epsilon + \nabla r_\epsilon &= \text{arot}(\mathbf{w}_\epsilon - \mathbf{w}_{\epsilon,[J-1]}) - \mathbf{E}_\epsilon \text{ in } \sigma_\epsilon, \\
 \mathbf{R}_\epsilon|_{\partial \sigma_\epsilon} &= 0, \quad \mathbf{R}_\epsilon(x', 0) = 0, \\
 \int_{\sigma_\epsilon} \mathbf{R}_\epsilon &= 0.
 \end{aligned} \tag{3.72}$$

Multiplying equation (3.72)<sub>1</sub> with  $\mathbf{R}_\epsilon$  and integrating over  $\sigma_\epsilon$ , we obtain:

$$\frac{1}{2} \frac{d}{dt} \int_{\sigma_\epsilon} |\mathbf{R}_\epsilon|^2 + \mu \int_{\sigma_\epsilon} |\nabla_{x'} \mathbf{R}_\epsilon|^2 = a \int_{\sigma_\epsilon} \text{rot}(\mathbf{w}_\epsilon - \mathbf{w}_{\epsilon,[J-1]}) \mathbf{R}_\epsilon - \int_{\sigma_\epsilon} \mathbf{E}_\epsilon \mathbf{R}_\epsilon + \int_{\sigma_\epsilon} \mathbf{q}_\epsilon \mathbf{R}_\epsilon, \tag{3.73}$$

where  $\mathbf{q}_\epsilon(t) = (q(t) - q_{\epsilon,[J]}(t), 0, 0)$ . Notice that the last term on the right-hand side is equal to zero due to (3.72)<sub>3</sub> and because  $\mathbf{q}_\epsilon$  is dependent only on the time variable  $t$ .

We estimate the terms on the right-hand side of (3.73) in the following way:

$$\begin{aligned}
 \left| \int_{\sigma_\epsilon} \operatorname{rot}(\mathbf{w}_\epsilon - \mathbf{w}_{\epsilon,[J-1]}) \mathbf{R}_\epsilon \right| &\leq C \|\nabla_{x'}(\mathbf{w}_\epsilon - \mathbf{w}_{\epsilon,[J-1]})\|_{L^2(\sigma_\epsilon)^3} \|\mathbf{R}_\epsilon\|_{L^2(\sigma_\epsilon)^3} \\
 &\leq C \|\nabla_{x'}(\mathbf{w}_\epsilon - \mathbf{w}_{\epsilon,[J]})\|_{L^2(\sigma_\epsilon)} \|\mathbf{R}_\epsilon\|_{L^2(\sigma_\epsilon)^3} \\
 &\quad + C \|\nabla_{x'}(\mathbf{w}_{\epsilon,[J]} - \mathbf{w}_{\epsilon,[J-1]})\|_{L^2(\sigma_\epsilon)} \|\mathbf{R}_\epsilon\|_{L^2(\sigma_\epsilon)^3} \\
 &\leq C\epsilon \|\nabla_{x'} \mathbf{s}_\epsilon\|_{L^2(\sigma_\epsilon)^3} \|\nabla_{x'} \mathbf{R}_\epsilon\|_{L^2(\sigma_\epsilon)} \\
 &\quad + C\epsilon^{J+3} \|\nabla_{x'} \mathbf{w}_J\|_{L^2(\sigma_\epsilon)^3} \|\nabla_{x'} \mathbf{R}_\epsilon\|_{L^2(\sigma_\epsilon)^3}, \\
 \left| \int_{\sigma_\epsilon} \mathbf{E}_\epsilon \mathbf{R}_\epsilon \right| &\leq \|\mathbf{E}_\epsilon\|_{L^2(\sigma_\epsilon)^3} \|\mathbf{R}_\epsilon\|_{L^2(\sigma_\epsilon)^3} \leq C\epsilon \|\mathbf{E}_\epsilon\|_{L^2(\sigma_\epsilon)^3} \|\nabla_{x'} \mathbf{R}_\epsilon\|_{L^2(\sigma_\epsilon)^3},
 \end{aligned}$$

where  $\mathbf{w}_J = \frac{1}{\epsilon^{J+2}}(\mathbf{w}_{\epsilon,[J]} - \mathbf{w}_{\epsilon,[J-1]})$ , implying

$$\begin{aligned}
 \frac{1}{2} \frac{d}{dt} \|\mathbf{R}_\epsilon\|_{L^2(\sigma_\epsilon)^3}^2 + \mu \|\nabla_{x'} \mathbf{R}_\epsilon\|_{L^2(\sigma_\epsilon)^3}^2 &\leq C\epsilon \|\nabla_{x'} \mathbf{s}_\epsilon\|_{L^2(\sigma_\epsilon)^3} \|\nabla_{x'} \mathbf{R}_\epsilon\|_{L^2(\sigma_\epsilon)^3} \\
 &\quad + C\epsilon^{J+3} \|\nabla_{x'} \mathbf{w}_J\|_{L^2(\sigma_\epsilon)^3} \|\nabla_{x'} \mathbf{R}_\epsilon\|_{L^2(\sigma_\epsilon)^3} \\
 &\quad + C\epsilon \|\mathbf{E}_\epsilon\|_{L^2(\sigma_\epsilon)^3} \|\nabla_{x'} \mathbf{R}_\epsilon\|_{L^2(\sigma_\epsilon)^3}.
 \end{aligned}$$

Applying Young's inequality and integrating over  $t$ , we obtain

$$\begin{aligned}
 \|\mathbf{R}_\epsilon\|_{L^2(\sigma_\epsilon)^3}^2 + \int_0^t \|\nabla_{x'} \mathbf{R}_\epsilon\|_{L^2(\sigma_\epsilon)^3}^2 &\leq C \int_0^t \left( \epsilon^2 \|\nabla_{x'} \mathbf{s}_\epsilon\|_{L^2(\sigma_\epsilon)^3}^2 + \epsilon^{2J+6} \|\nabla_{x'} \mathbf{w}_J\|_{L^2(\sigma_\epsilon)^3}^2 \right) \\
 &\quad + C \int_0^t \epsilon^2 \|\mathbf{E}_\epsilon\|_{L^2(\sigma_\epsilon)^3}^2.
 \end{aligned}$$

Taking into consideration (3.69), we obtain:

$$\begin{aligned}
 \|\mathbf{R}_\epsilon\|_{L^2(\sigma_\epsilon)^3}^2 + \int_0^t \|\nabla_{x'} \mathbf{R}_\epsilon\|_{L^2(\sigma_\epsilon)^3}^2 &\leq C\epsilon^2 \int_0^t \left( \epsilon^2 \|\nabla_{x'} \mathbf{R}_\epsilon\|_{L^2(\sigma_\epsilon)^3}^2 + \epsilon^{2J+6} \|\nabla_{x'} \mathbf{u}_J\|_{L^2(\sigma_\epsilon)^3}^2 \right) \\
 &\quad + C\epsilon^2 \int_0^t \epsilon^2 \|\mathbf{h}_\epsilon\|_{L^2(\sigma_\epsilon)^3}^2 + C\epsilon^{2J+6} \int_0^t \|\nabla_{x'} \mathbf{w}_J\|_{L^2(\sigma_\epsilon)^3}^2 \\
 &\quad + C\epsilon^2 \int_0^t \|\mathbf{E}_\epsilon\|_{L^2(\sigma_\epsilon)^3}^2
 \end{aligned}$$

For sufficiently small  $\epsilon$ , we have:

$$\begin{aligned}
 \|\mathbf{R}_\epsilon\|_{L^2(\sigma_\epsilon)^3}^2 + \int_0^t \|\nabla \mathbf{R}_\epsilon\|_{L^2(\sigma_\epsilon)^3}^2 &\leq C \int_0^t \left( \epsilon^{2J+8} \|\nabla_{x'} \mathbf{u}_J\|_{L^2(\sigma_\epsilon)^3}^2 + \epsilon^{2J+6} \|\nabla_{x'} \mathbf{w}_J\|_{L^2(\sigma_\epsilon)^3}^2 \right) \\
 &\quad + C \int_0^t \left( \epsilon^4 \|\mathbf{h}_\epsilon\|_{L^2(\sigma_\epsilon)^3}^2 + \epsilon^2 \|\mathbf{E}_\epsilon\|_{L^2(\sigma_\epsilon)^3}^2 \right).
 \end{aligned} \tag{3.74}$$

We now obtain from (3.69) and (3.74) the following estimate:

$$\begin{aligned} \|\mathbf{s}_\epsilon\|_{L^2(\sigma_\epsilon)^3}^2 + \int_0^t \|\nabla \mathbf{s}_\epsilon\|_{L^2(\sigma_\epsilon)^3}^2 &\leq C \int_0^t \left( \epsilon^{2J+6} \|\nabla_{x'} \mathbf{u}_J\|_{L^2(\sigma_\epsilon)^3}^2 + \epsilon^{2J+8} \|\nabla_{x'} \mathbf{w}_J\|_{L^2(\sigma_\epsilon)^3}^2 \right) \\ &\quad + C \int_0^t \left( \epsilon^2 \|\mathbf{h}_\epsilon\|_{L^2(\sigma_\epsilon)^3}^2 + \epsilon^4 \|\mathbf{E}_\epsilon\|_{L^2(\sigma_\epsilon)^3}^2 \right). \end{aligned} \quad (3.75)$$

Multiplying equation (3.72)<sub>1</sub> with  $\frac{\partial \mathbf{R}_\epsilon}{\partial t}$  and integrating over  $\sigma_\epsilon$ , we obtain:

$$\begin{aligned} &\frac{1}{2} \left\| \frac{\partial \mathbf{R}_\epsilon}{\partial t} \right\|_{L^2(\sigma_\epsilon)^3}^2 + \mu \frac{d}{dt} \|\nabla_{x'} \mathbf{R}_\epsilon\|_{L^2(\sigma_\epsilon)^3}^2 \\ &\leq C \left( \|\nabla_{x'} \mathbf{s}_\epsilon\|_{L^2(\sigma_\epsilon)^3} + \epsilon^{J+2} \|\nabla_{x'} \mathbf{w}_J\|_{L^2(\sigma_\epsilon)} + \|\mathbf{E}_\epsilon\|_{L^2(\sigma_\epsilon)^3} \right) \left\| \frac{\partial \mathbf{R}_\epsilon}{\partial t} \right\|_{L^2(\sigma_\epsilon)^3}. \end{aligned}$$

Applying Young's inequality, integrating over  $t$  and using estimate (3.75), we have:

$$\begin{aligned} \|\nabla_{x'} \mathbf{R}_\epsilon\|_{L^2(\sigma_\epsilon)^3}^2 + \int_0^t \left\| \frac{\partial \mathbf{R}_\epsilon}{\partial t} \right\|_{L^2(\sigma_\epsilon)^3}^2 &\leq C \int_0^t \left( \epsilon^{2J+6} \|\nabla_{x'} \mathbf{u}_J\|_{L^2(\sigma_\epsilon)^3}^2 + \epsilon^{2J+4} \|\nabla_{x'} \mathbf{w}_J\|_{L^2(\sigma_\epsilon)^3}^2 \right) \\ &\quad + C \int_0^t \left( \epsilon^2 \|\mathbf{h}_\epsilon\|_{L^2(\sigma_\epsilon)^3}^2 + \|\mathbf{E}_\epsilon\|_{L^2(\sigma_\epsilon)^3}^2 \right), \end{aligned} \quad (3.76)$$

Summing the inequalities (3.74) and (3.76), we have:

$$\begin{aligned} &\|\mathbf{R}_\epsilon\|_{W^{1,2}(\sigma_\epsilon)^3}^2 + \|\mathbf{R}_\epsilon\|_{L^2(0,t;W^{1,2}(\sigma_\epsilon)^3)}^2 + \left\| \frac{\partial \mathbf{R}_\epsilon}{\partial t} \right\|_{L^2(0,t;L^2(\sigma_\epsilon)^3)}^2 \\ &\leq C \int_0^t \left( \epsilon^{2J+6} \|\nabla_{x'} \mathbf{u}_J\|_{L^2(\sigma_\epsilon)^3}^2 + \epsilon^{2J+4} \|\nabla_{x'} \mathbf{w}_J\|_{L^2(\sigma_\epsilon)^3}^2 + \epsilon^2 \|\mathbf{h}_\epsilon\|_{L^2(\sigma_\epsilon)^3}^2 + \|\mathbf{E}_\epsilon\|_{L^2(\sigma_\epsilon)^3}^2 \right) \end{aligned}$$

and now from (3.71) and (3.74):

$$\begin{aligned} &\|\mathbf{s}_\epsilon\|_{W^{1,2}(\sigma_\epsilon^3)}^2 + \|\mathbf{s}_\epsilon\|_{L^2(0,t;W^{1,2}(\sigma_\epsilon^3))}^2 + \left\| \frac{\partial \mathbf{s}_\epsilon}{\partial t} \right\|_{L^2(0,t;L^2(\sigma_\epsilon^3))}^2 \\ &\leq C \int_0^t \left( \epsilon^{2J+4} \|\nabla_{x'} \mathbf{u}_J\|_{L^2(\sigma_\epsilon)^3}^2 + \epsilon^{2J+6} \|\nabla_{x'} \mathbf{w}_J\|_{L^2(\sigma_\epsilon)^3}^2 + \|\mathbf{h}_\epsilon\|_{L^2(\sigma_\epsilon)^3}^2 + \epsilon^2 \|\mathbf{E}_\epsilon\|_{L^2(\sigma_\epsilon)^3}^2 \right). \end{aligned} \quad (3.77)$$

The estimates for velocity (3.62) and (3.63) now follow directly taking the maximum over time.

We again consider the equation

$$\begin{aligned} \frac{\partial \mathbf{R}_\epsilon}{\partial t} - \mu \Delta_{x'} \mathbf{R}_\epsilon &= \mathbf{q}_\epsilon + a \operatorname{rot}(\mathbf{w}_\epsilon - \mathbf{w}_{\epsilon,[J-1]}) - \mathbf{E}_\epsilon, \\ \mathbf{R}_\epsilon|_{\partial\sigma_\epsilon} &= \mathbf{0}, \quad \mathbf{R}_\epsilon(x', 0) = \mathbf{0}, \\ \int_{\sigma_\epsilon} \mathbf{R}_\epsilon &= \mathbf{0}. \end{aligned}$$

Using the estimate [33, Chapter II, Section 2.2.4., Theorem 2.7, eq. (2.74)] yields:

$$\begin{aligned} \|\mathbf{q}_\epsilon\|_{L^2((0,t)^3)}^2 &\leq C \left( \|\mathbf{E}_\epsilon\|_{L^2(0,t;L^2(\sigma_\epsilon)^3)}^2 + \|\operatorname{rot}(\mathbf{w}_\epsilon - \mathbf{w}_{\epsilon,[J-1]})\|_{L^2(0,t;L^2(\sigma_\epsilon)^3)}^2 \right) \\ &\leq C \left( \|\mathbf{E}_\epsilon\|_{L^2(0,t;L^2(\sigma_\epsilon)^3)}^2 + \|\mathbf{s}_\epsilon\|_{L^2(0,t;W^{1,2}(\sigma_\epsilon)^3)}^2 + \epsilon^{2J+4} \|\mathbf{w}_J\|_{L^2(0,t;L^2(\sigma_\epsilon)^3)}^2 \right) \end{aligned}$$

Finally, taking the maximum over time in the above equation and using estimate (3.77), we obtain the pressure estimate (3.64), thus finishing the proof. □

## Chapter 4

# Asymptotic Analysis of the Nonsteady Micropolar Fluid Flow in a Thin Curved Pipe

In the last two decades, one can find a number of papers providing a rigorous derivation of new asymptotic models for steady-state flows in thin curved domains. The model describing the steady flow of a Newtonian fluid in a three-dimensional curved pipe has been formally derived and justified via error estimate by Marušić-Paloka [24]. The steady flow of a micropolar fluid has been investigated by Dupuy, Panasenko and Stavre [10]–[11] in two-dimensional domains such as a periodically constricted tubes and curvilinear channels. A three-dimensional setting for a curved pipe has been addressed by Pažanin in [28]. The asymptotic behaviour of nonsteady Newtonian fluid flow in a curved three-dimensional thin pipe with moving walls has been considered by Castineira et al. (see [8], [9]). In view of that and inspired by the applications, in this Chapter, following [30], we present the rigorous derivation of an asymptotic model describing the nonsteady micropolar fluid flow through a thin pipe with an arbitrary (generic) central curve.

The Chapter is organized as follows. In Section 4.1, we formally describe the geometry of the curved pipe using Germano's frame of reference (introduced in [15]–[16]) and consider the equations describing the nonsteady micropolar fluid flow. In Section 4.2, we introduce the curvilinear coordinates and rewrite the governing problem in an undeformed pipe. In Section 4.3, using two-scale expansion technique, we compute the asymptotic approximation up to the second-order in order to capture the effects of the pipe's geometry, micropolarity as well as the time derivative. It should be emphasized that the asymptotic solution is provided in the form of the explicit formulae, which is particularly important with regards to numerical simulations. We also conduct a detailed boundary layer analysis in the vicinity of pipe's ends and construct the divergence correction to improve the order of accuracy of our model. In Section 4.4, we prove the error estimates in suitable norms

evaluating the difference between the exact solution of the problem (which cannot be found due to the complexity of the flow domain and the equations) and our second-order asymptotic approximation. By doing that, we justify the usage of the proposed effective model and that represents the main contribution. Finally, in Appendix B and C, we provide the expressions for the operators in curvilinear coordinates as well as explicit expressions computed for the higher-order regular part correctors and for the exponentially decreasing functions appearing in the boundary layers problems, respectively.

## 4.1 Setting of the Problem

### 4.1.1 Description of the Domain

In the following we define our thin (or long) curved pipe  $\Omega_\epsilon^\alpha$  with a smooth central curve  $\gamma$  and a circular cross-section. We suppose that the curve  $\gamma$  is a generic curve in  $\mathbb{R}^3$  parameterized by its arc length  $x_1 \in [0, l]$ . We denote by  $\boldsymbol{\pi} \in C^3([0, l]; \mathbb{R}^3)$  its natural parametrization such that  $\boldsymbol{\pi}'(x_1) \neq 0$ , for every  $x_1 \in [0, l]$ . At each point  $\boldsymbol{\pi}(x_1)$  of the curve  $\gamma$  we define its curvature (flexion) as  $\kappa(x_1) = |\boldsymbol{\pi}''(x_1)|$  and introduce Frenet's basis by

$$\mathbf{t} = \boldsymbol{\pi}', \quad \mathbf{n} = \frac{1}{\kappa} \mathbf{t}', \quad \mathbf{b} = \mathbf{t} \times \mathbf{n},$$

where  $\mathbf{t}$  is the tangent,  $\mathbf{n}$  the normal and  $\mathbf{b}$  the binormal. The torsion of  $\gamma$  is denoted by  $\tau(x_1) = -|\mathbf{b}'(x_1)|$ . It is known that the Frenet's basis  $(\mathbf{t}, \mathbf{n}, \mathbf{b})$  satisfies the system

$$\mathbf{t}' = \kappa \mathbf{n}, \quad \mathbf{n}' = -\kappa \mathbf{t} + \tau \mathbf{b}, \quad \mathbf{b}' = -\tau \mathbf{n}.$$

Let  $0 < \epsilon \ll 1$  be a small parameter and  $B = B(0, 1) \subset \mathbb{R}^2$  a unit circle. We define the undeformed thin pipe as

$$\Omega_\epsilon = \{x = (x_1, x_2, x_3) \in \mathbb{R}^3 : x_1 \in \langle 0, l \rangle, x' = (x_2, x_3) \in B_\epsilon = \epsilon B\} = \langle 0, l \rangle \times B_\epsilon.$$

Next, we introduce the mapping  $\Phi_\epsilon^\alpha : \Omega_\epsilon \rightarrow \mathbb{R}^3$  by

$$\Phi_\epsilon^\alpha(x) = \boldsymbol{\pi}(x_1) + x_2 \mathbf{n}_\alpha(x_1) + x_3 \mathbf{b}_\alpha(x_1),$$

where

$$\begin{aligned} \mathbf{n}_\alpha(x_1) &= \cos \alpha(x_1) \mathbf{n}(x_1) + \sin \alpha(x_1) \mathbf{b}(x_1), \\ \mathbf{b}_\alpha(x_1) &= -\sin \alpha(x_1) \mathbf{n}(x_1) + \cos \alpha(x_1) \mathbf{b}(x_1), \end{aligned}$$

and

$$\alpha(x_1) = - \int_{x_0}^{x_1} \tau(\xi) d\xi + \alpha_0,$$

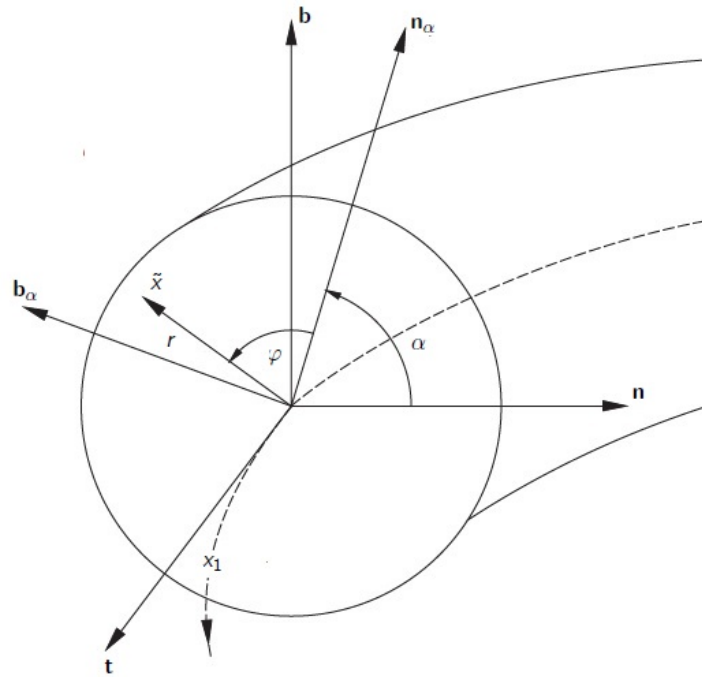

**Figure 4.1:** Germano's frame of reference.

with  $x_0$  and  $\alpha_0$  being arbitrary constants. The local injectivity of  $\Phi_\epsilon^\alpha$  can be easily established assuming  $\epsilon$  is sufficiently small (see [28, Section 3.1] for details).

We can now define the curved pipe with the central curve  $\gamma$  and circular cross-section  $B^\epsilon$  by putting

$$\Omega_\epsilon^\alpha = \Phi_\epsilon^\alpha(\Omega_\epsilon).$$

We also denote by  $\Sigma_\epsilon^i = \Phi_\epsilon^\alpha(\{i\} \times B_\epsilon)$ ,  $i = 0, l$  the ends of the pipe and by  $\Gamma_\epsilon^\alpha = \Phi_\epsilon^\alpha(\langle 0, l \rangle \times \partial B_\epsilon)$  its lateral boundary.

### 4.1.2 Micropolar Equations

The equations describing the nonsteady flow of a micropolar fluid in a thin curved pipe  $\Omega_\epsilon^\alpha$  read:

$$\begin{aligned} \frac{\partial \mathbf{u}_\epsilon}{\partial t} - \mu \Delta \mathbf{u}_\epsilon + \nabla p_\epsilon &= a \operatorname{rot} \mathbf{w}_\epsilon + \mathbf{F}, \\ \operatorname{div} \mathbf{u}_\epsilon &= 0, \quad \text{in } \Omega_\epsilon^\alpha, \\ \frac{\partial \mathbf{w}_\epsilon}{\partial t} - \delta \Delta \mathbf{w}_\epsilon - \beta \nabla \operatorname{div} \mathbf{w}_\epsilon + 2a \mathbf{w}_\epsilon &= a \operatorname{rot} \mathbf{u}_\epsilon + \mathbf{G}. \end{aligned} \tag{4.1}$$

Here  $\mathbf{u}_\epsilon$  is the velocity field,  $p_\epsilon$  is the pressure and  $\mathbf{w}_\epsilon$  is the microrotation field. The external sources of linear and angular momentum are given by the functions  $\mathbf{F}(\tilde{x}, t) = \mathbf{f}(x_1, t)$  and  $\mathbf{G}(\tilde{x}, t) = \mathbf{g}(x_1, t)$ , where  $\tilde{x} = \Phi_\epsilon^\alpha(x)$ . We employ the notation  $\mu = \nu + \nu_r$ ,  $a = 2\nu_r$ ,  $\delta = c_a + c_d$  and  $\beta = c_0 + c_d - c_a$ , where  $\nu$  is the Newtonian viscosity,  $\nu_r$  is the



microrotation viscosity, while  $c_0, c_a$  and  $c_d$  are the coefficients of angular viscosities.

We prescribe the following boundary and initial condition:

$$\begin{aligned} \mathbf{u}_\epsilon &= \mathbf{0} \text{ on } \Gamma_\epsilon^\alpha, \quad \mathbf{u}_\epsilon = \epsilon^2 \mathbf{h}_i^\epsilon \text{ on } \Sigma_\epsilon^i, \quad i = 0, l, \\ \mathbf{w}_\epsilon &= \mathbf{0} \text{ on } \partial\Omega_\epsilon^\alpha, \\ \mathbf{u}_\epsilon(\tilde{x}, 0) &= \mathbf{0}, \quad \mathbf{w}_\epsilon(\tilde{x}, 0) = \mathbf{0}, \end{aligned} \quad (4.2)$$

where we suppose that the prescribed velocities  $\mathbf{h}_0^\epsilon, \mathbf{h}_l^\epsilon$  are given in the form

$$\mathbf{h}_0^\epsilon(\tilde{x}, t) = h_0^t \left( \frac{x'}{\epsilon}, t \right) \mathbf{t}(0) + h_0^n \left( \frac{x'}{\epsilon}, t \right) \mathbf{n}(0) + h_0^b \left( \frac{x'}{\epsilon}, t \right) \mathbf{b}(0), \quad (4.3)$$

for  $\tilde{x} = \Phi_\epsilon^\alpha(0, x')$ , and

$$\mathbf{h}_l^\epsilon(\tilde{x}, t) = h_l^t \left( \frac{x'}{\epsilon}, t \right) \mathbf{t}(l) + h_l^n \left( \frac{x'}{\epsilon}, t \right) \mathbf{n}(l) + h_l^b \left( \frac{x'}{\epsilon}, t \right) \mathbf{b}(l), \quad (4.4)$$

for  $\tilde{x} = \Phi_\epsilon^\alpha(l, x')$ . To assure the well-posedness of the governing problem, the following compatibility condition needs to be fulfilled:

$$F(t) = \int_{B_\epsilon} h_i^t \left( \frac{x'}{\epsilon}, t \right) = \epsilon^2 \int_B h_i^t(y', t) = \epsilon^2 F_0^*(t), \quad i = 0, l, \quad (4.5)$$

where  $y' = \frac{x'}{\epsilon}$ . Since the initial velocity equals to zero, there also needs to hold

$$F(0) = 0. \quad (4.6)$$

In the following, we suppose that  $\mathbf{h}_0^\epsilon, \mathbf{h}_l^\epsilon, \mathbf{F}$  and  $\mathbf{G}$  vanish in the neighborhood of  $t = 0$ , that is

$$\mathbf{h}_0^\epsilon(\cdot, t), \mathbf{h}_l^\epsilon(\cdot, t), \mathbf{F}(\cdot, t), \mathbf{G}(\cdot, t), \quad \forall t \in [0, T^*], \quad T^* > 0. \quad (4.7)$$

Let  $\frac{\partial^j \mathbf{h}_0^\epsilon}{\partial t^j} \in L^2(0, T; H^{1/2}(\Sigma_\epsilon^0)^3)$  and  $\frac{\partial^j \mathbf{h}_l^\epsilon}{\partial t^j} \in L^2(0, T; H^{1/2}(\Sigma_\epsilon^l)^3)$  for  $j = 0, 1$  and let  $\mathbf{h}_\epsilon \in L^2(0, T; W^{1,2}(\Omega_\epsilon^\alpha)^3)$  with  $\frac{\partial \mathbf{h}_\epsilon}{\partial t} \in L^2(0, T; W^{1,2}(\Omega_\epsilon^\alpha)^3)$  be the solution of the following problem (see Lemma 4.3):

$$\begin{aligned} \operatorname{div} \mathbf{h}_\epsilon &= 0 \text{ in } \Omega_\epsilon^\alpha, \\ \mathbf{h}_\epsilon &= \mathbf{0} \text{ on } \Gamma_\epsilon^\alpha, \\ \mathbf{h}_\epsilon &= \epsilon^2 \mathbf{h}_i^\epsilon \text{ on } \Sigma_\epsilon^i, \quad i = 0, l. \end{aligned}$$

A weak solution of our problem (4.1)–(4.7) is a pair  $(\mathbf{u}_\epsilon, \mathbf{w}_\epsilon) = (\mathbf{v}_\epsilon + \mathbf{h}_\epsilon, \mathbf{w}_\epsilon)$  such that  $\operatorname{div} \mathbf{v}_\epsilon = 0, \mathbf{v}_\epsilon(\tilde{x}, 0) = 0, \mathbf{w}_\epsilon(\tilde{x}, 0) = 0, \mathbf{v}_\epsilon, \mathbf{w}_\epsilon \in L^2(0, T; W_0^{1,2}(\Omega_\epsilon^\alpha)^3) \cap L^\infty(0, T; W_0^{1,2}(\Omega_\epsilon^\alpha)^3)$

$\cap W^{1,2}(0, T; L^2(\Omega_\epsilon^\alpha)^3)$ , and  $(\mathbf{v}_\epsilon, \mathbf{w}_\epsilon)$  satisfy the integral identities

$$\begin{aligned}
 & \int_{\Omega_\epsilon^\alpha} \frac{\partial \mathbf{v}_\epsilon}{\partial t} \boldsymbol{\varphi} + \mu \int_{\Omega_\epsilon^\alpha} \nabla \mathbf{v}_\epsilon \nabla \boldsymbol{\varphi} = a \int_{\Omega_\epsilon^\alpha} \text{rot} \mathbf{w}_\epsilon \boldsymbol{\varphi} + \int_{\Omega_\epsilon^\alpha} \mathbf{F} \boldsymbol{\varphi} \\
 & - \int_{\Omega_\epsilon^\alpha} \frac{\partial \mathbf{h}_\epsilon}{\partial t} \boldsymbol{\varphi} - \int_{\Omega_\epsilon^\alpha} \nabla \mathbf{h}_\epsilon \nabla \boldsymbol{\varphi}, \quad \forall \boldsymbol{\varphi} \in W_0^{1,2}(\Omega_\epsilon^\alpha)^3, \quad \text{div} \boldsymbol{\varphi} = 0, \\
 & \int_{\Omega_\epsilon^\alpha} \frac{\partial \mathbf{w}_\epsilon}{\partial t} \boldsymbol{\psi} + \delta \int_{\Omega_\epsilon^\alpha} \nabla \mathbf{w}_\epsilon \nabla \boldsymbol{\psi} + \beta \int_{\Omega_\epsilon^\alpha} \text{div} \mathbf{w}_\epsilon \text{div} \boldsymbol{\psi} + 2a \int_{\Omega_\epsilon^\alpha} \mathbf{w}_\epsilon \boldsymbol{\psi} \\
 & = a \int_{\Omega_\epsilon^\alpha} \text{rot}(\mathbf{v}_\epsilon + \mathbf{h}_\epsilon) \boldsymbol{\psi} + \int_{\Omega_\epsilon^\alpha} \mathbf{G} \boldsymbol{\psi}, \quad \forall \boldsymbol{\psi} \in W_0^{1,2}(\Omega_\epsilon^\alpha)^3.
 \end{aligned} \tag{4.8}$$

Let  $\mathbf{F}, \mathbf{G} \in L^2(0, T; L^2(\Omega_\epsilon^\alpha)^3)$ . There then exists a unique weak solution  $(\mathbf{v}_\epsilon, \mathbf{w}_\epsilon)$  satisfying (4.8) for a.e.  $t \in [0, T]$ . The proof follows the same arguments as the proof of Theorem 2.1.1 from [22, Chapter III, Section 2] which can be straightforwardly adapted to our setting.

## 4.2 Curvilinear Coordinates

### 4.2.1 Geometric Tools

We need to study the inverse mapping of the change of variables  $\Phi_\epsilon^\alpha$  and write our problem in the reference domain. We consider the mapping:

$$\begin{aligned}
 \tilde{\Phi}_\epsilon^\alpha &: \Omega_\epsilon \times [0, T] \rightarrow \Omega_\epsilon^\alpha \times [0, T], \\
 \tilde{\Phi}_\epsilon^\alpha(x, t) &= (\tilde{x}, \tilde{t}) = (\Phi_\epsilon^\alpha(x), \tilde{t}),
 \end{aligned}$$

and the associated Jacobian is given with

$$\mathcal{J}_{\tilde{\Phi}_\epsilon^\alpha} = \begin{bmatrix} \frac{\partial \tilde{x}_1}{\partial x_1} & \frac{\partial \tilde{x}_1}{\partial x_2} & \frac{\partial \tilde{x}_1}{\partial x_3} & \frac{\partial \tilde{x}_1}{\partial t} \\ \frac{\partial \tilde{x}_2}{\partial x_1} & \frac{\partial \tilde{x}_2}{\partial x_2} & \frac{\partial \tilde{x}_2}{\partial x_3} & \frac{\partial \tilde{x}_2}{\partial t} \\ \frac{\partial \tilde{x}_3}{\partial x_1} & \frac{\partial \tilde{x}_3}{\partial x_2} & \frac{\partial \tilde{x}_3}{\partial x_3} & \frac{\partial \tilde{x}_3}{\partial t} \\ \frac{\partial \tilde{t}}{\partial x_1} & \frac{\partial \tilde{t}}{\partial x_2} & \frac{\partial \tilde{t}}{\partial x_3} & \frac{\partial \tilde{t}}{\partial t} \end{bmatrix} = \begin{bmatrix} \nabla_x \tilde{x} & \frac{\partial \tilde{x}}{\partial t} \\ \frac{\partial \tilde{t}}{\partial x_1} & \frac{\partial \tilde{t}}{\partial x_2} & \frac{\partial \tilde{t}}{\partial x_3} & \frac{\partial \tilde{t}}{\partial t} \end{bmatrix} = \begin{bmatrix} \nabla_x \tilde{x} & 0 \\ 0 & 0 & 0 & 1 \end{bmatrix},$$

where  $\nabla_x \tilde{x} = \nabla_x \Phi_\epsilon^\alpha$ . We introduce the *covariant basis* as the gradient of the mapping  $\Phi_\epsilon^\alpha$  consisting of vectors

$$\mathbf{a}_i(x) = \frac{\partial \Phi_\epsilon^\alpha(x)}{\partial x_i} = \frac{\partial \tilde{x}}{\partial x_i},$$

with

$$\begin{aligned}
 \tilde{x} = \Phi_\epsilon^\alpha(x) &= \boldsymbol{\pi}(x_1) + x_2(\cos \alpha(x_1) \mathbf{n}(x_1) + \sin \alpha(x_1) \mathbf{b}(x_1)) \\
 &+ x_3(-\sin \alpha(x_1) \mathbf{n}(x_1) + \cos \alpha(x_1) \mathbf{b}(x_1)).
 \end{aligned}$$

We easily obtain

$$\begin{aligned}\mathbf{a}_1 &= \frac{\partial \tilde{x}}{\partial x_1} = (1 - \kappa(e_\alpha \cdot x'))\mathbf{t} - (\alpha' + \tau)(e_\alpha^\perp \cdot x')\mathbf{n} + (\alpha' + \tau)(e_\alpha \cdot x')\mathbf{b}, \\ \mathbf{a}_2 &= \frac{\partial \tilde{x}}{\partial x_2} = \cos \alpha \mathbf{n} + \sin \alpha \mathbf{b}, \\ \mathbf{a}_3 &= \frac{\partial \tilde{x}}{\partial x_3} = -\sin \alpha \mathbf{n} + \cos \alpha \mathbf{b},\end{aligned}$$

where

$$e_\alpha = (\cos \alpha, -\sin \alpha), \quad e_\alpha^\perp = (\sin \alpha, \cos \alpha). \quad (4.9)$$

We remind that  $\alpha' = -\tau$  so that

$$\mathbf{a}_1 = (1 - \kappa(e_\alpha \cdot x'))\mathbf{t}.$$

The vectors of the covariant basis represent the columns of  $\nabla_x \Phi_\epsilon^\alpha$ , namely

$$\begin{aligned}\nabla_x \Phi_\epsilon^\alpha &= [\mathbf{a}_1 \ \mathbf{a}_2 \ \mathbf{a}_3] = [\mathbf{t} \ \mathbf{n} \ \mathbf{b}] \begin{bmatrix} 1 - \kappa(e_\alpha \cdot x') & 0 & 0 \\ 0 & \cos \alpha & -\sin \alpha \\ 0 & \sin \alpha & \cos \alpha \end{bmatrix} \\ &= \mathbf{B} \begin{bmatrix} 1 - \kappa(e_\alpha \cdot x') & 0 & 0 \\ 0 & \cos \alpha & -\sin \alpha \\ 0 & \sin \alpha & \cos \alpha \end{bmatrix} = \begin{bmatrix} t_1 & n_1 & b_1 \\ t_2 & n_2 & b_2 \\ t_3 & n_3 & b_3 \end{bmatrix} \begin{bmatrix} 1 - \kappa(e_\alpha \cdot x') & 0 & 0 \\ 0 & \cos \alpha & -\sin \alpha \\ 0 & \sin \alpha & \cos \alpha \end{bmatrix} \\ &= \begin{bmatrix} (1 - \kappa(e_\alpha \cdot x'))t_1 & n_1 \cos \alpha + b_1 \sin \alpha & -n_1 \sin \alpha + b_1 \cos \alpha \\ (1 - \kappa(e_\alpha \cdot x'))t_2 & n_2 \cos \alpha + b_2 \sin \alpha & -n_2 \sin \alpha + b_2 \cos \alpha \\ (1 - \kappa(e_\alpha \cdot x'))t_3 & n_3 \cos \alpha + b_3 \sin \alpha & -n_3 \sin \alpha + b_3 \cos \alpha \end{bmatrix} = \begin{bmatrix} \frac{\partial \tilde{x}_1}{\partial x_1} & \frac{\partial \tilde{x}_1}{\partial x_2} & \frac{\partial \tilde{x}_1}{\partial x_3} \\ \frac{\partial \tilde{x}_2}{\partial x_1} & \frac{\partial \tilde{x}_2}{\partial x_2} & \frac{\partial \tilde{x}_2}{\partial x_3} \\ \frac{\partial \tilde{x}_3}{\partial x_1} & \frac{\partial \tilde{x}_3}{\partial x_2} & \frac{\partial \tilde{x}_3}{\partial x_3} \end{bmatrix},\end{aligned}$$

where  $\mathbf{B} = [\mathbf{t} \ \mathbf{n} \ \mathbf{b}]$  and we have

$$\det(\nabla_x \tilde{x}) = \det(\nabla_x \Phi_\epsilon^\alpha) = \det(\mathcal{J}_{\tilde{\Phi}_\epsilon^\alpha}) = 1 - \kappa(e_\alpha \cdot x').$$

The inverse mapping  $(\tilde{\Phi}_\epsilon^\alpha)^{-1}: \Omega_\epsilon^\alpha \rightarrow [0, T] \times \Omega_\epsilon: [0, T]$  is such that its Jacobian, denoted by  $(\mathcal{J}_{\tilde{\Phi}_\epsilon^\alpha})^{-1}$ , is given by

$$(\mathcal{J}_{\tilde{\Phi}_\epsilon^\alpha})^{-1} = \begin{bmatrix} \frac{\partial x_1}{\partial \tilde{x}_1} & \frac{\partial x_1}{\partial \tilde{x}_2} & \frac{\partial x_1}{\partial \tilde{x}_3} & \frac{\partial x_1}{\partial \tilde{t}} \\ \frac{\partial x_2}{\partial \tilde{x}_1} & \frac{\partial x_2}{\partial \tilde{x}_2} & \frac{\partial x_2}{\partial \tilde{x}_3} & \frac{\partial x_2}{\partial \tilde{t}} \\ \frac{\partial x_3}{\partial \tilde{x}_1} & \frac{\partial x_3}{\partial \tilde{x}_2} & \frac{\partial x_3}{\partial \tilde{x}_3} & \frac{\partial x_3}{\partial \tilde{t}} \\ \frac{\partial t}{\partial \tilde{x}_1} & \frac{\partial t}{\partial \tilde{x}_2} & \frac{\partial t}{\partial \tilde{x}_3} & \frac{\partial t}{\partial \tilde{t}} \end{bmatrix} = \begin{bmatrix} & \nabla_{\tilde{x}} x & & \frac{\partial x}{\partial \tilde{t}} \\ \frac{\partial t}{\partial \tilde{x}_1} & \frac{\partial t}{\partial \tilde{x}_2} & \frac{\partial t}{\partial \tilde{x}_3} & \frac{\partial t}{\partial \tilde{t}} \end{bmatrix}.$$

Therefore,  $\mathcal{J}_{\tilde{\Phi}_\epsilon^\alpha} \mathcal{J}_{\tilde{\Phi}_\epsilon^\alpha}^{-1} = \mathbb{I}$ , and we find the following relations:

$$\begin{aligned} \nabla_{\tilde{x}} x &= (\nabla_x \tilde{x})^{-1} = (\nabla_x \Phi_\epsilon^\alpha)^{-1}, \\ \frac{\partial x}{\partial \tilde{t}} &= -(\nabla_{\tilde{x}} x) \frac{\partial \tilde{x}}{\partial \tilde{t}} = 0. \end{aligned}$$

The *contravariant basis* is the dual basis to the covariant basis, i.e. it is defined by the relation

$$\mathbf{a}^i \cdot \mathbf{a}_j = \delta_{ij}.$$

It can be easily verified that

$$\mathbf{a}^1 = \frac{1}{1 - \kappa(e_\alpha \cdot x')} \mathbf{t}, \quad \mathbf{a}^2 = \cos \alpha \mathbf{n} + \sin \alpha \mathbf{b}, \quad \mathbf{a}^3 = -\sin \alpha \mathbf{n} + \cos \alpha \mathbf{b}.$$

The vectors of the contravariant basis represent the rows of  $(\nabla_x \Phi_\epsilon^\alpha)^{-1}$ , namely

$$\begin{aligned} (\nabla_x \Phi_\epsilon^\alpha)^{-1} &= \begin{bmatrix} \mathbf{a}^1 \\ \mathbf{a}^2 \\ \mathbf{a}^3 \end{bmatrix} = \begin{bmatrix} \frac{1}{1 - \kappa(e_\alpha \cdot x')} & 0 & 0 \\ 0 & \cos \alpha & \sin \alpha \\ 0 & -\sin \alpha & \cos \alpha \end{bmatrix} [\mathbf{t} \ \mathbf{n} \ \mathbf{b}]^t \\ &= \begin{bmatrix} \frac{1}{1 - \kappa(e_\alpha \cdot x')} & 0 & 0 \\ 0 & \cos \alpha & \sin \alpha \\ 0 & -\sin \alpha & \cos \alpha \end{bmatrix} \begin{bmatrix} t_1 & t_2 & t_3 \\ n_1 & n_2 & n_3 \\ b_1 & b_2 & b_3 \end{bmatrix} \\ &= \begin{bmatrix} \frac{1}{1 - \kappa(e_\alpha \cdot x')} t_1 & \frac{1}{1 - \kappa(e_\alpha \cdot x')} t_2 & \frac{1}{1 - \kappa(e_\alpha \cdot x')} t_3 \\ n_1 \cos \alpha + b_1 \sin \alpha & n_2 \cos \alpha + b_2 \sin \alpha & n_3 \cos \alpha + b_3 \sin \alpha \\ -n_1 \sin \alpha + b_1 \cos \alpha & -n_2 \sin \alpha + b_2 \cos \alpha & -n_3 \sin \alpha + b_3 \cos \alpha \end{bmatrix} \end{aligned}$$

$$= \begin{bmatrix} \frac{\partial x_1}{\partial \tilde{x}_1} & \frac{\partial x_1}{\partial \tilde{x}_2} & \frac{\partial x_1}{\partial \tilde{x}_3} \\ \frac{\partial x_2}{\partial \tilde{x}_1} & \frac{\partial x_2}{\partial \tilde{x}_2} & \frac{\partial x_2}{\partial \tilde{x}_3} \\ \frac{\partial x_3}{\partial \tilde{x}_1} & \frac{\partial x_3}{\partial \tilde{x}_2} & \frac{\partial x_3}{\partial \tilde{x}_3} \end{bmatrix}.$$

### 4.2.2 Christoffel Symbols

Christoffel's symbols are given with the relation

$$\Gamma_{jk}^i = \mathbf{a}^i \cdot \frac{\partial \mathbf{a}_k}{\partial x_j},$$

and there holds  $\Gamma_{jk}^i = \Gamma_{kj}^i$  (they are symmetric in lower indices). We obtain

$$\begin{aligned} \Gamma_{11}^1 &= -\frac{(\kappa'(e_\alpha \cdot x') + \kappa\tau(e_\alpha^\perp \cdot x'))}{1 - \kappa(e_\alpha \cdot x')}, & \Gamma_{12}^1 &= \Gamma_{21}^1 = -\frac{\kappa \cos \alpha}{1 - \kappa(e_\alpha \cdot x')}, \\ \Gamma_{13}^1 &= \Gamma_{31}^1 = \frac{\kappa \sin \alpha}{1 - \kappa(e_\alpha \cdot x')}, & \Gamma_{11}^2 &= \kappa(1 - \kappa(e_\alpha \cdot x')) \cos \alpha, \\ \Gamma_{11}^3 &= -\kappa(1 - \kappa(e_\alpha \cdot x')) \sin \alpha, \end{aligned}$$

with all other  $\Gamma_{jk}^i$  being equal to zero.

### 4.2.3 Asymptotic Behaviour

We take into account that  $x_2 = \mathcal{O}(\epsilon)$  and  $x_3 = \mathcal{O}(\epsilon)$  and determine the asymptotic behaviour of  $(\nabla \Phi_\epsilon^\alpha)^{-1}$  and  $\Gamma_{jk}^i$ .

We have

$$\begin{aligned} (\nabla \Phi_\epsilon^\alpha)^{-1} &= \begin{bmatrix} 1 & 0 & 0 \\ 1 - \epsilon\kappa(e_\alpha \cdot x') & 0 & 0 \\ 0 & \cos \alpha & \sin \alpha \\ 0 & -\sin \alpha & \cos \alpha \end{bmatrix} \mathbf{B}^t \\ &= \begin{bmatrix} 1 + \epsilon\kappa(e_\alpha \cdot y') + \epsilon^2\kappa^2(e_\alpha \cdot y') & 0 & 0 \\ 0 & \cos \alpha & \sin \alpha \\ 0 & -\sin \alpha & \cos \alpha \end{bmatrix} \mathbf{B}^t + \mathcal{O}(\epsilon^3). \end{aligned}$$

The Christoffel's symbol are given with

$$\begin{aligned} \Gamma_{11}^1 &= -(\kappa'(e_\alpha \cdot x') + \kappa\tau(e_\alpha^\perp \cdot x')) + \mathcal{O}(\epsilon^2), & \Gamma_{12}^1 &= \Gamma_{21}^1 = -(1 + \kappa(e_\alpha \cdot x'))\kappa \cos \alpha + \mathcal{O}(\epsilon^2), \\ \Gamma_{13}^1 &= \Gamma_{31}^1 = (1 + \kappa(e_\alpha \cdot x'))\kappa \sin \alpha + \mathcal{O}(\epsilon^2), & \Gamma_{11}^2 &= \kappa(1 - \kappa(e_\alpha \cdot x')) \cos \alpha, \\ \Gamma_{11}^3 &= -\kappa(1 - \kappa(e_\alpha \cdot x')) \sin \alpha. \end{aligned}$$

### 4.2.4 Differential Operators

The derivation of the differential operators in curvilinear coordinates can be found in [2].

The operators are given with the following expressions:

$$\begin{aligned}
(\nabla_{S_\epsilon})^t \circ \tilde{\Phi}_\epsilon^\alpha &= (\nabla \Phi_\epsilon^\alpha)^{-t} (\nabla S_\epsilon)^t, \\
(\nabla \tilde{\mathbf{v}}_\epsilon) \circ \tilde{\Phi}_\epsilon^\alpha &= (\nabla \Phi_\epsilon^\alpha)^{-t} \left( \left[ \frac{\partial U_\epsilon^k}{\partial x_l} \right]_{k,l} - U_\epsilon^j \mathbf{\Gamma}^j \right) (\nabla \Phi_\epsilon^\alpha)^{-1}, \quad \mathbf{\Gamma}^i(x) = [\Gamma_{jk}^i]_{j,k}, \\
(\Delta \tilde{\mathbf{v}}_\epsilon) \circ \tilde{\Phi}_\epsilon^\alpha &= (\nabla \Phi_\epsilon^\alpha)^{-t} \left( \frac{\partial}{\partial x_i} \left( \left[ \frac{\partial U_\epsilon^k}{\partial x_l} \right]_{k,l} - U_\epsilon^j \mathbf{\Gamma}^j \right) - \left( \left[ \frac{\partial U_\epsilon^k}{\partial x_l} \right] - U_\epsilon^j \mathbf{\Gamma}^j \right) \hat{\mathbf{\Gamma}}_i \right. \\
&\quad \left. - \hat{\mathbf{\Gamma}}_i^t \left( \left[ \frac{\partial U_\epsilon^k}{\partial x_l} \right]_{k,l} - U_\epsilon^j \mathbf{\Gamma}^j \right) \right) (\nabla \Phi_\epsilon^\alpha)^{-1} \mathbf{a}^i, \quad \hat{\mathbf{\Gamma}}_i(x) = [\Gamma_{ik}^j]_{j,k}, \\
((\text{rot} \tilde{\mathbf{v}}_\epsilon) \circ \tilde{\Phi}_\epsilon^\alpha) \times \mathbf{c} &= (\nabla \Phi_\epsilon^\alpha)^{-t} (\text{rot} \mathbf{V}_\epsilon \times (\nabla \Phi_\epsilon^\alpha)^{-1} \mathbf{c}), \quad \mathbf{c} \in \mathbb{R}^3,
\end{aligned}$$

where

$$\begin{aligned}
S_\epsilon &= s_\epsilon \circ \tilde{\Phi}_\epsilon^\alpha, \\
\mathbf{V}_\epsilon &= \tilde{\mathbf{v}}_\epsilon \circ \tilde{\Phi}_\epsilon^\alpha = U_\epsilon^1 \mathbf{a}^1 + U_\epsilon^2 \mathbf{a}^2 + U_\epsilon^3 \mathbf{a}^3.
\end{aligned}$$

The explicit expressions are computed in Appendix B.

### 4.2.5 Equations in the Reference Domain

Let us denote the scalar field

$$S_\epsilon = s_\epsilon \circ \tilde{\Phi}_\epsilon^\alpha,$$

where  $\tilde{\Phi}_\epsilon^\alpha: \Omega_\epsilon \times [0, T] \rightarrow \Omega_\epsilon^\alpha: [0, T]$ ,  $s_\epsilon: \Omega_\epsilon^\alpha \times [0, T] \rightarrow \mathbb{R}$  and  $S_\epsilon: \Omega_\epsilon \times [0, T] \rightarrow \mathbb{R}$ .

We also introduce the vector fields

$$\begin{aligned}
\mathbf{V}_\epsilon &= \tilde{\mathbf{v}}_\epsilon \circ \tilde{\Phi}_\epsilon^\alpha = U_\epsilon^1 \mathbf{a}^1 + U_\epsilon^2 \mathbf{a}^2 + U_\epsilon^3 \mathbf{a}^3, \\
\mathbf{Z}_\epsilon &= \mathbf{z}_\epsilon \circ \tilde{\Phi}_\epsilon^\alpha = Z_\epsilon^1 \mathbf{a}^1 + Z_\epsilon^2 \mathbf{a}^2 + Z_\epsilon^3 \mathbf{a}^3,
\end{aligned}$$

where  $\tilde{\mathbf{v}}_\epsilon, \mathbf{z}_\epsilon: \Omega_\epsilon^\alpha \times [0, T] \rightarrow \mathbb{R}^3$  and  $\mathbf{V}_\epsilon, \mathbf{Z}_\epsilon: \Omega_\epsilon \times [0, T] \rightarrow \mathbb{R}^3$ . By  $U_\epsilon^i = \mathbf{V}_\epsilon \cdot \mathbf{a}_i$ ,  $Z_\epsilon^i = \mathbf{Z}_\epsilon \cdot \mathbf{a}_i$  we denote the corresponding covariant components.

Using the expressions for the differential operators in curvilinear coordinates derived in Appendix B, we can write the equations (4.1) on the reference domain  $\Omega_\epsilon$ .

The equation (4.1)<sub>1</sub> expressing the balance of momentum in the reference domain  $\Omega_\epsilon$  takes the following form:

$$\begin{aligned}
 & \frac{\partial U_\epsilon^1}{\partial t} (1 + \kappa(e_\alpha \cdot x') + \dots) \mathbf{t} + \frac{\partial U_\epsilon^2}{\partial t} \mathbf{a}^2 + \frac{\partial U_\epsilon^3}{\partial t} \mathbf{a}^3 - \mu \left( \Delta U_\epsilon^1 + \kappa \cos \alpha \left( \frac{\partial U_\epsilon^1}{\partial x_2} - \frac{\partial U_\epsilon^2}{\partial x_1} \right) \right) \mathbf{t} \\
 & - \mu \left( \kappa \sin \alpha \left( \frac{\partial U_\epsilon^3}{\partial x_1} - \frac{\partial U_\epsilon^1}{\partial x_3} \right) - \frac{\partial}{\partial x_1} \left( U_\epsilon^2 \kappa \cos \alpha - U_\epsilon^3 \kappa \sin \alpha \right) \right) \mathbf{t} \\
 & + \mu \left( \kappa^2 U_\epsilon^1 - \kappa(e_\alpha \cdot x') \left( \Delta U_\epsilon^1 - \kappa \cos \alpha \frac{\partial U_\epsilon^1}{\partial x_2} + \kappa \sin \alpha \frac{\partial U_\epsilon^1}{\partial x_3} + \kappa(e_\alpha \cdot x') \Delta U_\epsilon^1 \right) + \dots \right) \mathbf{t} \\
 & - \mu \left( \Delta U_\epsilon^2 - \kappa \cos \alpha \frac{\partial U_\epsilon^2}{\partial x_2} + \kappa \sin \alpha \frac{\partial U_\epsilon^2}{\partial x_3} + 2\kappa(e_\alpha \cdot x') \left( -\kappa \cos \alpha \frac{\partial U_\epsilon^2}{\partial x_2} + \kappa \sin \alpha \frac{\partial U_\epsilon^2}{\partial x_3} \right) \right) \mathbf{a}^2 \\
 & - \mu \left( \left( 2\kappa \frac{\partial U_\epsilon^1}{\partial x_1} + \kappa' U_\epsilon^1 - \kappa^2 U_\epsilon^2 \right) \cos \alpha + \kappa \tau U_\epsilon^1 \sin \alpha + \kappa^2 \cos \alpha (e_\alpha \cdot x') \frac{\partial U_\epsilon^2}{\partial x_2} \right) \mathbf{a}^2 \\
 & + \mu \left( \kappa^2 \sin \alpha (e_\alpha \cdot x') \frac{\partial U_\epsilon^2}{\partial x_3} + \dots \right) \mathbf{a}^2 - \mu \left( \kappa \sin \alpha \frac{\partial U_\epsilon^3}{\partial x_3} - \kappa \cos \alpha \frac{\partial U_\epsilon^3}{\partial x_2} + \kappa \tau U_\epsilon^1 \cos \alpha \right) \mathbf{a}^3 \\
 & - \mu \left( \Delta U_\epsilon^3 + 2\kappa(e_\alpha \cdot x') \left( \kappa \sin \alpha \frac{\partial U_\epsilon^3}{\partial x_3} - \kappa \cos \alpha \frac{\partial U_\epsilon^3}{\partial x_2} \right) - \left( 2\kappa \frac{\partial U_\epsilon^1}{\partial x_1} + \kappa' U_\epsilon^1 - \kappa^2 U_\epsilon^2 \right) \sin \alpha \right) \mathbf{a}^3 \\
 & - \mu \left( \kappa^2 \cos \alpha (e_\alpha \cdot x') \frac{\partial U_\epsilon^3}{\partial x_2} - \kappa^2 \sin \alpha (e_\alpha \cdot x') \frac{\partial U_\epsilon^3}{\partial x_3} + \dots \right) \mathbf{a}^3 \\
 & + \frac{\partial S_\epsilon}{\partial x_1} (1 + \kappa(e_\alpha \cdot x') + \dots) \mathbf{t} + \frac{\partial S_\epsilon}{\partial x_2} \mathbf{a}^2 + \frac{\partial x_\epsilon}{\partial x_3} \mathbf{a}^3 = a \left( \frac{\partial Z_\epsilon^3}{\partial x_2} - \frac{\partial Z_\epsilon^2}{\partial x_3} \right) \mathbf{t} \\
 & + a(1 + \kappa(e_\alpha \cdot x') + \dots) \left( \left( \frac{\partial Z_\epsilon^1}{\partial x_3} - \frac{\partial Z_\epsilon^3}{\partial x_1} \right) \mathbf{a}^2 + \left( \frac{\partial Z_\epsilon^2}{\partial x_1} - \frac{\partial Z_\epsilon^1}{\partial x_2} \right) \mathbf{a}^3 \right) \\
 & + f^1 \mathbf{t} + (f^2 \cos \alpha + f^3 \sin \alpha) \mathbf{a}^2 + (f^3 \cos \alpha - f^2 \sin \alpha) \mathbf{a}^3.
 \end{aligned} \tag{4.10}$$

The equation (4.1)<sub>2</sub> expressing the balance of mass can be written in the reference domain  $\Omega_\epsilon$  as:

$$\begin{aligned}
 & \left( \frac{1}{1 - \kappa(e_\alpha \cdot x')} \right)^2 \left( \frac{\partial U_\epsilon^1}{\partial x_1} - \kappa(U_\epsilon^2 \cos \alpha - U_\epsilon^3 \sin \alpha) + (\kappa'(e_\alpha \cdot x') + \kappa \tau (e_\alpha^\perp \cdot x')) U_\epsilon^1 \right. \\
 & \left. + \kappa(e_\alpha \cdot x') (\kappa'(e_\alpha \cdot x') + \kappa \tau (e_\alpha^\perp \cdot x')) U_\epsilon^1 + \kappa^2 (e_\alpha \cdot x') \cos \alpha U_\epsilon^2 - \kappa^2 (e_\alpha \cdot x') \sin \alpha U_\epsilon^3 \right) \\
 & + \frac{\partial U_\epsilon^2}{\partial x_2} + \frac{\partial U_\epsilon^3}{\partial x_3} = \frac{\partial U_\epsilon^1}{\partial x_1} - \kappa(U_\epsilon^2 \cos \alpha - U_\epsilon^3 \sin \alpha) + (\kappa'(e_\alpha \cdot x') + \kappa \tau (e_\alpha^\perp \cdot x')) U_\epsilon^1 \\
 & + \kappa(e_\alpha \cdot x') (\kappa'(e_\alpha \cdot x') + \kappa \tau (e_\alpha^\perp \cdot x')) U_\epsilon^1 + \kappa^2 (e_\alpha \cdot x') \cos \alpha U_\epsilon^2 - \kappa^2 (e_\alpha \cdot x') \sin \alpha U_\epsilon^3 \\
 & + \frac{\partial U_\epsilon^2}{\partial x_2} + \frac{\partial U_\epsilon^3}{\partial x_3} + 2\kappa(e_\alpha \cdot x') \left( \frac{\partial U_\epsilon^1}{\partial x_1} - \kappa(U_\epsilon^2 \cos \alpha - U_\epsilon^3 \sin \alpha) \right. \\
 & \left. + (\kappa'(e_\alpha \cdot x') + \kappa \tau (e_\alpha^\perp \cdot x')) U_\epsilon^1 + \kappa^2 (e_\alpha \cdot x') \cos \alpha U_\epsilon^2 - \kappa^2 (e_\alpha \cdot x') \sin \alpha U_\epsilon^3 \right) \\
 & + 3\kappa^2 (e_\alpha \cdot x')^2 \left( \frac{\partial U_\epsilon^1}{\partial x_1} - \kappa(U_\epsilon^2 \cos \alpha - U_\epsilon^3 \sin \alpha) \right) + 4\kappa^3 (e_\alpha \cdot x')^3 \frac{\partial U_\epsilon^1}{\partial x_1} + \mathcal{O}(\epsilon^3) = 0.
 \end{aligned} \tag{4.11}$$

Finally, the equation (4.1)<sub>3</sub> describing the balance of angular momentum in the reference domain  $\Omega_\epsilon$  reads:

$$\begin{aligned}
& \frac{\partial Z_\epsilon^1}{\partial t} (1 + \kappa(e_\alpha \cdot x') + \dots) \mathbf{t} + \frac{\partial Z_\epsilon^2}{\partial t} \mathbf{a}^2 + \frac{\partial Z_\epsilon^3}{\partial t} \mathbf{a}^3 - \delta \left( \Delta Z_\epsilon^1 + \kappa \cos \alpha \left( \frac{\partial Z_\epsilon^1}{\partial x_2} - \frac{\partial Z_\epsilon^2}{\partial x_1} \right) + \kappa^2 Z_\epsilon^1 \right) \mathbf{t} \\
& - \delta \left( \kappa \sin \alpha \left( \frac{\partial Z_\epsilon^3}{\partial x_1} - \frac{\partial Z_\epsilon^1}{\partial x_3} \right) - \frac{\partial}{\partial x_1} \left( Z_\epsilon^2 \kappa \cos \alpha - Z_\epsilon^3 \kappa \sin \alpha \right) \right) \mathbf{t} \\
& + \delta \left( -\kappa(e_\alpha \cdot x') \left( \Delta Z_\epsilon^1 - \kappa \cos \alpha \frac{\partial Z_\epsilon^1}{\partial x_2} + \kappa \sin \alpha \frac{\partial Z_\epsilon^1}{\partial x_3} + \kappa(e_\alpha \cdot x') \Delta Z_\epsilon^1 \right) + \dots \right) \mathbf{t} \\
& - \delta \left( \Delta Z_\epsilon^2 - \kappa \cos \alpha \frac{\partial Z_\epsilon^2}{\partial x_2} + \kappa \sin \alpha \frac{\partial Z_\epsilon^2}{\partial x_3} + 2\kappa(e_\alpha \cdot x') \left( -\kappa \cos \alpha \frac{\partial Z_\epsilon^2}{\partial x_2} + \kappa \sin \alpha \frac{\partial Z_\epsilon^2}{\partial x_3} \right) \right) \mathbf{a}^2 \\
& - \delta \left( \left( 2\kappa \frac{\partial Z_\epsilon^1}{\partial x_1} + \kappa' Z_\epsilon^1 - \kappa^2 Z_\epsilon^2 \right) \cos \alpha + \kappa \tau Z_\epsilon^1 \sin \alpha + \kappa^2 \cos \alpha (e_\alpha \cdot x') \frac{\partial Z_\epsilon^2}{\partial x_2} \right) \mathbf{a}^2 \\
& + \delta \left( \kappa^2 \sin \alpha (e_\alpha \cdot x') \frac{\partial Z_\epsilon^2}{\partial x_3} + \dots \right) \mathbf{a}^2 \\
& - \delta \left( \Delta Z_\epsilon^3 + \kappa \sin \alpha \frac{\partial Z_\epsilon^3}{\partial x_3} - \kappa \cos \alpha \frac{\partial Z_\epsilon^3}{\partial x_2} + \kappa \tau Z_\epsilon^1 \cos \alpha \right) \mathbf{a}^3 \\
& - \delta \left( 2\kappa(e_\alpha \cdot x') \left( \kappa \sin \alpha \frac{\partial Z_\epsilon^3}{\partial x_3} - \kappa \cos \alpha \frac{\partial Z_\epsilon^3}{\partial x_2} \right) - \left( 2\kappa \frac{\partial Z_\epsilon^1}{\partial x_1} + \kappa' Z_\epsilon^1 - \kappa^2 Z_\epsilon^2 \right) \sin \alpha \right) \mathbf{a}^3 \\
& - \delta \left( \kappa^2 \cos \alpha (e_\alpha \cdot x') \frac{\partial Z_\epsilon^3}{\partial x_2} - \kappa^2 \sin \alpha (e_\alpha \cdot x') \frac{\partial Z_\epsilon^3}{\partial x_3} + \dots \right) \mathbf{a}^3 \\
& - \beta \left( (1 + \kappa(e_\alpha \cdot x') + \dots) \left( \frac{\partial^2 Z_\epsilon^1}{\partial x_1^2} - (\kappa \cos \alpha)' Z_\epsilon^2 - \kappa \cos \alpha \frac{\partial Z_\epsilon^2}{\partial x_1} \right) \right) \mathbf{t} \\
& - \beta (1 + \kappa(e \cdot x') + \dots) \left( (\kappa \sin \alpha)' Z_\epsilon^3 + \kappa \sin \alpha \frac{\partial Z_\epsilon^3}{\partial x_1} + \frac{\partial^2 Z_\epsilon^2}{\partial x_1 \partial x_2} + \frac{\partial^2 Z_\epsilon^3}{\partial x_1 \partial x_3} + \dots \right) \mathbf{t} \\
& - \beta \left( \frac{\partial^2 Z_\epsilon^1}{\partial x_1 \partial x_2} - \kappa \left( \frac{\partial Z_\epsilon^2}{\partial x_2} \cos \alpha - \frac{\partial Z_\epsilon^3}{\partial x_2} \sin \alpha \right) + (\kappa' Z_\epsilon^1 + \kappa^2 \cos \alpha Z_\epsilon^2 - \kappa^2 \sin \alpha Z_\epsilon^3) \cos \alpha \right) \mathbf{a}^2 \\
& - \beta \left( 2\kappa \cos \alpha \frac{\partial Z_\epsilon^1}{\partial x_1} - 2\kappa^2 (Z_\epsilon^2 \cos \alpha - Z_\epsilon^3 \sin \alpha) \cos \alpha + \kappa^2 (e_\alpha \cdot x') \frac{\partial Z_\epsilon^2}{\partial x_2} \cos \alpha \right) \mathbf{a}^2 \\
& - \beta \left( \left( \kappa' (e_\alpha \cdot x') + \kappa \tau (e_\alpha^\perp \cdot x') \right) \frac{\partial Z_\epsilon^1}{\partial x_2} - \kappa^2 (e_\alpha \cdot x') \frac{\partial Z_\epsilon^3}{\partial x_2} \sin \alpha + \frac{\partial^2 Z_\epsilon^2}{\partial x_2^2} + \frac{\partial^2 Z_\epsilon^3}{\partial x_2 \partial x_3} \right) \mathbf{a}^2 \\
& - \beta \left( 2\kappa(e_\alpha \cdot x') \left( \frac{\partial^2 Z_\epsilon^1}{\partial x_1 \partial x_2} - \kappa \left( \frac{\partial Z_\epsilon^2}{\partial x_2} \cos \alpha - \frac{\partial Z_\epsilon^3}{\partial x_2} \sin \alpha \right) \right) + \kappa \tau Z_\epsilon^1 \sin \alpha + \dots \right) \mathbf{a}^2 \\
& - \beta \left( \frac{\partial^2 Z_\epsilon^1}{\partial x_1 \partial x_3} - \kappa \left( \frac{\partial Z_\epsilon^2}{\partial x_3} \cos \alpha - \frac{\partial Z_\epsilon^3}{\partial x_3} \sin \alpha \right) \right) \mathbf{a}^3 \\
& - \beta \left( -(\kappa' Z_\epsilon^1 + \kappa^2 \cos \alpha Z_\epsilon^2 - \kappa^2 \sin \alpha Z_\epsilon^3) \sin \alpha \right) \mathbf{a}^3 \\
& - \beta \left( 2\kappa \left( \frac{\partial Z_\epsilon^1}{\partial x_1} - \kappa \left( Z_\epsilon^2 \cos \alpha - Z_\epsilon^3 \sin \alpha \right) \right) \sin \alpha + \kappa' (e_\alpha \cdot x') \frac{\partial Z_\epsilon^1}{\partial x_3} + \kappa \tau (e_\alpha^\perp \cdot x') \frac{\partial Z_\epsilon^1}{\partial x_3} \right) \mathbf{a}^3 \\
& - \beta \left( \kappa^2 (e_\alpha \cdot x') \cos \alpha \frac{\partial Z_\epsilon^2}{\partial x_3} - \kappa^2 (e_\alpha \cdot x') \frac{\partial Z_\epsilon^3}{\partial x_3} \sin \alpha + \frac{\partial^2 Z_\epsilon^2}{\partial x_2 \partial x_3} + \frac{\partial^2 Z_\epsilon^3}{\partial x_3^2} + \kappa \tau Z_\epsilon^1 \cos \alpha \right) \mathbf{a}^3 \\
& - \beta \left( 2\kappa(e_\alpha \cdot x') \left( \frac{\partial^2 Z_\epsilon^1}{\partial x_1 \partial x_3} - \kappa \left( \frac{\partial Z_\epsilon^2}{\partial x_3} \cos \alpha - \frac{\partial Z_\epsilon^3}{\partial x_3} \sin \alpha \right) \right) + \dots \right) \mathbf{a}^3 \\
& + 2a(1 + \kappa(e_\alpha \cdot x') + \dots) Z_\epsilon^1 \mathbf{t} + 2a Z_\epsilon^2 \mathbf{a}^2 + 2a Z_\epsilon^3 \mathbf{a}^3 = a \left( \frac{\partial U_\epsilon^3}{\partial x_2} - \frac{\partial U_\epsilon^2}{\partial x_3} \right) \mathbf{t}
\end{aligned}$$



$$\begin{aligned}
 & + a \left( (1 + \kappa(e_\alpha \cdot x') + \dots) \left( \frac{\partial U_\epsilon^1}{\partial x_3} - \frac{\partial U_\epsilon^3}{\partial x_1} \right) \right) \mathbf{a}^2 \\
 & + a \left( (1 + \kappa(e_\alpha \cdot x') + \dots) \left( \frac{\partial U_\epsilon^2}{\partial x_1} - \frac{\partial U_\epsilon^1}{\partial x_2} \right) \right) \mathbf{a}^3 \\
 & + g^1 \mathbf{t} + (g^2 \cos \alpha + g^3 \sin \alpha) \mathbf{a}^2 + (g^3 \cos \alpha - g^2 \sin \alpha) \mathbf{a}^3.
 \end{aligned} \tag{4.12}$$

Note that

$$\mathbf{f} = f^1 \mathbf{t} + f^2 \mathbf{n} + f^3 \mathbf{b}, \quad \mathbf{g} = g^1 \mathbf{t} + g^2 \mathbf{n} + g^3 \mathbf{b}.$$

## 4.3 Asymptotic Expansion

### 4.3.1 Regular Part

In this section, we construct the regular part of the asymptotic approximation of the solution  $(\mathbf{u}_\epsilon, \mathbf{w}_\epsilon, p_\epsilon)$ . In view of that, let us introduce

$$\begin{aligned}
 \mathbf{U}_\epsilon &= \mathbf{u}_\epsilon \circ \tilde{\Phi}_\epsilon^\alpha = V_\epsilon^1 \mathbf{a}^1 + V_\epsilon^2 \mathbf{a}^2 + V_\epsilon^3 \mathbf{a}^3, \\
 \mathbf{W}_\epsilon &= \mathbf{w}_\epsilon \circ \tilde{\Phi}_\epsilon^\alpha = W_\epsilon^1 \mathbf{a}^1 + W_\epsilon^2 \mathbf{a}^2 + W_\epsilon^3 \mathbf{a}^3, \\
 P_\epsilon &= p_\epsilon \circ \tilde{\Phi}_\epsilon^\alpha,
 \end{aligned}$$

and formally expand (for  $i = 1, 2, 3$ )

$$\begin{aligned}
 V_\epsilon^i(x, t) &= \epsilon^2 V_0^i \left( x_1, \frac{x_2}{\epsilon}, \frac{x_3}{\epsilon}, t \right) + \epsilon^3 V_1^i \left( x_1, \frac{x_2}{\epsilon}, \frac{x_3}{\epsilon}, t \right) + \epsilon^4 V_2^i \left( x_1, \frac{x_2}{\epsilon}, \frac{x_3}{\epsilon}, t \right) + \dots, \\
 W_\epsilon^i(x, t) &= \epsilon^2 W_0^i \left( x_1, \frac{x_2}{\epsilon}, \frac{x_3}{\epsilon}, t \right) + \epsilon^3 W_1^i \left( x_1, \frac{x_2}{\epsilon}, \frac{x_3}{\epsilon}, t \right) + \epsilon^4 W_2^i \left( x_1, \frac{x_2}{\epsilon}, \frac{x_3}{\epsilon}, t \right) + \dots, \\
 P_\epsilon(x, t) &= P_0(x_1, t) + \epsilon P_1 \left( x_1, \frac{x_2}{\epsilon}, \frac{x_3}{\epsilon}, t \right) + \epsilon^2 P_2 \left( x_1, \frac{x_2}{\epsilon}, \frac{x_3}{\epsilon}, t \right) + \epsilon^3 P_3 \left( x_1, \frac{x_2}{\epsilon}, \frac{x_3}{\epsilon}, t \right) + \dots
 \end{aligned} \tag{4.13}$$

### Zero-order approximation

We first compute the zero-order approximation for the velocity  $\mathbf{V}_0 = (V_0^1, V_0^2, V_0^3)$  and the microrotation  $\mathbf{W}_0 = (W_0^1, W_0^2, W_0^3)$ . Plugging the expansions (4.13) into the equations (4.10)–(4.11) and collecting the  $\epsilon^0$  terms, we obtain the following:

$$\begin{aligned}
 & -\mu \left( \Delta_{y'} V_0^1 \mathbf{t} + \Delta_{y'} V_0^2 \mathbf{a}^2 + \Delta_{y'} V_0^3 \mathbf{a}^3 \right) + \frac{\partial P_0}{\partial x_1} \mathbf{t} + \frac{\partial P_1}{\partial y_2} \mathbf{a}^2 + \frac{\partial P_1}{\partial y_3} \mathbf{a}^3 \\
 & = f^1 \mathbf{t} + (\cos \alpha f^2 + \sin \alpha f^3) \mathbf{a}^2 + (-\sin \alpha f^2 + \cos \alpha f^3) \mathbf{a}^3, \\
 & \operatorname{div}_{y'} \mathbf{V}_0 = 0,
 \end{aligned}$$

where we have introduced the operators with respect to the cross-section variables  $y' = \frac{x'}{\epsilon}$ :

$$\Delta_{y'}V = \frac{\partial^2 V}{\partial y_2^2} + \frac{\partial^2 V}{\partial y_3^2}, \quad \operatorname{div}_{y'}\mathbf{V} = \frac{\partial V^2}{\partial y_2} + \frac{\partial V^3}{\partial y_3},$$

for a scalar function  $V$  and vector function  $\mathbf{V} = (V^1, V^2, V^3)$ .

In this way, we obtain the problem for the velocity and pressure zero-order approximation posed in  $\Omega = \langle 0, l \rangle \times B$ :

$$\begin{aligned} & -\mu(\Delta_{y'}V_0^1, \Delta_{y'}V_0^2, \Delta_{y'}V_0^3) + \left( \frac{\partial P_0}{\partial x_1}, \frac{\partial P_1}{\partial y_2}, \frac{\partial P_1}{\partial y_3} \right) \\ & = (f^1, f^2 \cos \alpha + f^3 \sin \alpha, f^3 \cos \alpha - f^2 \sin \alpha) \text{ in } \Omega, \\ & \operatorname{div}_{y'}\mathbf{V}_0 = 0 \text{ in } \Omega, \\ & \mathbf{V}_0 = \mathbf{0} \text{ on } \Gamma = \langle 0, l \rangle \times \partial B. \end{aligned} \tag{4.14}$$

The system (4.14) can be solved by taking

$$\begin{aligned} V_0^1(x_1, y', t) &= \frac{1}{4\mu}(1 - |y'|^2) \left( f^1(x_1, t) - \frac{\partial P_0(x_1, t)}{\partial x_1} \right), \quad V_0^2 = V_0^3 = 0, \\ P_1(x_1, y', t) &= f^2(x_1, t)(e_\alpha(x_1) \cdot y') + f^3(x_1, t)(e_\alpha^\perp(x_1) \cdot y'), \end{aligned} \tag{4.15}$$

where  $e_\alpha(x_1)$  and  $e_\alpha^\perp(x_1)$  are given by (4.9).

To determine the zero-order pressure approximation, we collect the  $\epsilon^2$  terms in the divergence equation to obtain:

$$\frac{\partial V_0^1}{\partial x_1} + \operatorname{div}_{y'}\mathbf{V}_1 = 0 \quad \text{in } \Omega. \tag{4.16}$$

Integrating (4.16) over  $B$  and using the divergence theorem yields

$$\frac{\partial}{\partial x_1} \int_B V_0^1 = 0.$$

The boundary conditions give

$$\int_B V_0^1(0, y', t) = \int_B V_0^1(l, y', t) = F_0^*(t),$$

(justified in Section 4.2) implying

$$\int_B V_0^1 = F_0^*(t). \tag{4.17}$$

From (4.15) and (4.17) we now get

$$\frac{\pi}{8\mu} \left( f^1(x_1, t) - \frac{\partial P_0(x_1, t)}{\partial x_1} \right) = F_0^*(t),$$

to obtain

$$P_0(x_1, t) = -\frac{8\mu}{\pi} F_0^*(t)x_1 + \int_0^{x_1} f^1(\xi, t)d\xi + p_0(t), \quad (4.18)$$

where  $p_0(t)$  is an arbitrary function of time. It now follows from (4.15)<sub>1</sub> and (4.18) that

$$V_0^1(y', t) = \frac{2}{\pi}(1 - |y'|^2)F_0^*(t). \quad (4.19)$$

We now turn our attention to computing the microrotation zero-order approximation  $\mathbf{W}_0 = (W_0^1, W_0^2, W_0^3)$ . Plugging the expansions (4.13) into (4.12), we arrive at the following problem:

$$\begin{aligned} -\delta\Delta_{y'}\mathbf{W}_0 - \beta\nabla_{y'}(\operatorname{div}_{y'}\mathbf{W}_0) &= (g^1, g^2 \cos \alpha + g^3 \sin \alpha, g^3 \cos \alpha - g^2 \sin \alpha) \text{ in } \Omega, \\ \mathbf{W}_0 &= \mathbf{0} \text{ on } \Gamma, \end{aligned}$$

where we have introduced the gradient operator with respect to the cross-section variables

$$\nabla_{y'}W = \left( \frac{\partial W}{\partial y_2}, \frac{\partial W}{\partial y_3} \right),$$

for a scalar function  $W$ . This leads to

$$\begin{aligned} W_0^1(x_1, y', t) &= \frac{1}{4\delta}(1 - |y'|^2)g^1(x_1, t), \\ W_0^2(x_1, y', t) &= \frac{1}{2(2\delta + \beta)}(1 - |y'|^2)(g^2(x_1, t) \cos \alpha(x_1) + g^3(x_1, t) \sin \alpha(x_1)), \\ W_0^3(x_1, y', t) &= \frac{1}{2(2\delta + \beta)}(1 - |y'|^2)(g^3(x_1, t) \cos \alpha(x_1) - g^2(x_1, t) \sin \alpha(x_1)). \end{aligned} \quad (4.20)$$

As expected, the zero-order velocity and microrotation approximation given by (4.19) and (4.20) do not feel the effects of curvature, torsion, micropolarity or the time derivative so we need to compute the first and second-order correctors to capture those effects.

### First-order corrector

Again, substituting (4.13) into the equation (4.10) and collecting the terms of order  $\epsilon$ , we get the following equation for the first component of the velocity first-order corrector  $V_1^1$ :

$$\begin{aligned} -\mu \left( \Delta_{y'}V_1^1 + \kappa \cos \alpha \frac{\partial V_0^1}{\partial y_2} - \kappa \sin \alpha \frac{\partial V_0^1}{\partial y_3} + \kappa(e_\alpha \cdot y')\Delta_{y'}V_0^1 \right) \\ + \kappa(e_\alpha \cdot y') \frac{\partial P_0}{\partial x_1} + \frac{\partial P_1}{\partial x_1} = a \left( \frac{\partial W_0^3}{\partial y_2} - \frac{\partial W_0^2}{\partial y_3} \right) \text{ in } \Omega. \end{aligned} \quad (4.21)$$

Substituting the expressions for  $V_0^1, P_0, P_1, W_0^2$  and  $W_0^3$  derived in the previous section and given by (4.15), (4.18), (4.19) and (4.20) into (4.21), we obtain the following problem for  $V_1^1$ :

$$\begin{aligned} -\mu\Delta_{y'}V_1^1 &= y_2H^1(x_1, t) + y_3H^2(x_1, t) \text{ in } \Omega, \\ V_1^1 &= 0 \text{ on } \Gamma, \end{aligned} \quad (4.22)$$

where the functions  $H^1(x_1, t)$  and  $H^2(x_1, t)$  are provided in the Appendix (see (C.1)).

It can be easily shown that the solution of problem (4.22) is given by

$$V_1^1(x_1, y', t) = \frac{1}{8\mu}(1 - |y'|^2)(y_2H^1(x_1, t) + y_3H^2(x_1, t)). \quad (4.23)$$

In a similar manner, we obtain the equations for the two other velocity components  $\mathbf{V}_1^* = (V_1^2, V_1^3)$ :

$$\begin{aligned} -\mu(\Delta_{y'}V_1^2 - \kappa \cos \alpha \frac{\partial V_0^2}{\partial y_2} + \kappa \sin \alpha \frac{\partial V_0^2}{\partial y_3}, \Delta_{y'}V_1^3 + \kappa \sin \alpha \frac{\partial V_0^3}{\partial y_3} - \kappa \cos \alpha \frac{\partial V_0^3}{\partial y_2}) \\ + \left( \frac{\partial P_2}{\partial y_2}, \frac{\partial P_2}{\partial y_3} \right) = a \left( \frac{\partial W_0^1}{\partial y_3}, -\frac{\partial W_0^1}{\partial y_2} \right) \text{ in } \Omega, \\ \frac{\partial V_0^1}{\partial x_1} - \kappa V_0^2 + \frac{\partial V_1^2}{\partial y_2} + \frac{\partial V_1^3}{\partial y_3} = 0 \text{ in } \Omega, \quad \mathbf{V}_1^* = \mathbf{0} \text{ on } \Gamma. \end{aligned} \quad (4.24)$$

Applying the expressions for  $V_0^1, V_0^2, V_0^3$  and  $W_0^1$  given by (4.15), (4.19) and (4.20) into the equation (4.24), we arrive at:

$$\begin{aligned} -\mu\Delta_{y'}\mathbf{V}_1^* + \nabla_{y'}P_2 &= -\frac{a}{2\delta}g^1(x_1, t)(y_3, -y_2) \text{ in } \Omega, \\ \operatorname{div}_{y'}\mathbf{V}_1^* &= 0 \text{ in } \Omega, \quad \mathbf{V}_1^* = \mathbf{0} \text{ on } \Gamma. \end{aligned} \quad (4.25)$$

The solution of the problem (4.25) reads:

$$\begin{aligned} V_1^2(x_1, y', t) &= -\frac{a}{16\mu\delta}g^1(x_1, t)(1 - |y'|^2)y_3, \quad V_1^3(x_1, y', t) = \frac{a}{16\mu\delta}g^1(x_1, t)(1 - |y'|^2)y_2, \\ P_2(x_1, t) &= x_1p^1(t) + \frac{1}{2}x_1^2\left(\frac{p^2(t) - p^1(t)}{l}\right), \end{aligned} \quad (4.26)$$

where  $p^1(t)$  and  $p^2(t)$  will be determined in Section 4.3.2 from the compatibility conditions related to the second-order boundary layer correctors for the velocity and pressure.

We will now determine the expressions for the microrotation first-order corrector. Plugging (4.13) into the equation (4.12), and collecting the terms of order  $\epsilon$ , we obtain:

$$\begin{aligned} & -\delta\left(\Delta_{y'}W_1^1 + \kappa\cos\alpha\frac{\partial W_0^1}{\partial y_2} - \kappa\sin\alpha\frac{\partial W_0^1}{\partial y_3} + \kappa(e_\alpha \cdot y')\Delta_{y'}W_0^1\right) \\ & -\beta\left(\frac{\partial^2 W_0^2}{\partial x_1\partial y_2} + \frac{\partial^2 W_0^3}{\partial x_1\partial y_3}\right) = a\left(\frac{\partial V_0^3}{\partial y_2} - \frac{\partial V_0^2}{\partial y_3}\right). \end{aligned} \quad (4.27)$$

Employing the expressions for  $V_0^2, V_0^3, W_0^1, W_0^2$  and  $W_0^3$  given by (4.15) and (4.20) in the equation (4.27), we get the following problem for  $W_1^1$ :

$$\begin{aligned} -\delta\Delta_{y'}W_1^1 &= y_2H^3(x_1, t) + y_3H^4(x_1, t) \text{ in } \Omega, \\ W_1^1 &= 0 \text{ on } \Gamma, \end{aligned} \quad (4.28)$$

where  $H^3(x_1, t)$  and  $H^4(x_1, t)$  are given in the Appendix (see (C.2)).

It follows

$$W_1^1(x_1, y', t) = \frac{1}{8\mu}(1 - |y'|^2)(y_2H^3(x_1, t) + y_3H^4(x_1, t)). \quad (4.29)$$

Substituting the expansions (4.13) into the equation (4.12), we deduce the equations for  $(W_1^2, W_1^3)$ :

$$\begin{aligned} & -\delta\left(\Delta_{y'}W_1^2 - \kappa\cos\alpha\frac{\partial W_0^2}{\partial y_2} + \kappa\sin\alpha\frac{\partial W_0^2}{\partial y_3}\right) \\ & -\beta\left(\frac{\partial^2 W_0^1}{\partial x_1\partial y_2} - \kappa\cos\alpha\frac{\partial W_0^2}{\partial y_2} + \kappa\sin\alpha\frac{\partial W_0^3}{\partial y_2} + \frac{\partial^2 W_1^2}{\partial y_2^2} + \frac{\partial^2 W_1^3}{\partial y_2\partial y_3}\right) = a\frac{\partial V_0^1}{\partial y_3}, \\ & -\delta\left(\Delta_{y'}W_1^3 + \kappa\sin\alpha\frac{\partial W_0^3}{\partial y_3} - \kappa\cos\alpha\frac{\partial W_0^3}{\partial y_2}\right) \\ & -\beta\left(\frac{\partial^2 W_0^1}{\partial x_1\partial y_3} - \kappa\cos\alpha\frac{\partial W_0^2}{\partial y_3} + \kappa\sin\alpha\frac{\partial W_0^3}{\partial y_3} + \frac{\partial^2 W_1^3}{\partial y_3^2} + \frac{\partial^2 W_1^2}{\partial y_2\partial y_3}\right) = -a\frac{\partial V_0^1}{\partial y_2}. \end{aligned}$$

In view of the expressions for  $V_0^1, W_0^1, W_0^2$  and  $W_0^3$  given by (4.15), (4.19) and (4.20), we obtain the following problem for  $(W_1^2, W_1^3)$ :

$$\begin{aligned} -\delta\Delta_{y'}W_1^2 - \beta\left(\frac{\partial^2 W_1^2}{\partial y_2^2} + \frac{\partial^2 W_1^3}{\partial y_2\partial y_3}\right) &= y_2H^5(x_1, t) + y_6H^6(x_1, t) \text{ in } \Omega, \\ -\delta\Delta_{y'}W_1^3 - \beta\left(\frac{\partial^2 W_1^3}{\partial y_3^2} + \frac{\partial^2 W_1^2}{\partial y_2\partial y_3}\right) &= y_2H^7(x_1, t) + y_3H^8(x_1, t) \text{ in } \Omega, \\ W_1^2 = W_1^3 &= 0 \text{ on } \Gamma, \end{aligned} \quad (4.30)$$

where  $H^5(x_1, t), \dots, H^8(x_1, t)$  can be found in the Appendix (see (C.3)).

The solution of the problem (4.30) can be written as:

$$\begin{aligned} W_1^2(x_1, y', t) &= (1 - |y'|^2)(y_2 H^9(x_1, t) + y_3 H^{10}(x_1, t)), \\ W_1^3(x_1, y', t) &= (1 - |y'|^2)(y_2 H^{11}(x_1, t) + y_3 H^{12}(x_1, t)), \end{aligned} \quad (4.31)$$

where  $H^9(x_1, t), \dots, H^{12}(x_1, t)$  are given in the Appendix (see (C.4)).

Looking at the obtained expressions for the velocity and microrotation first-order correctors (see (4.23), (4.26), (4.29), (4.31) with (C.1)–(C.4)), we can clearly see the effects of the curvature, torsion and micropolarity, as in the steady case (see [28, Section 4.2]). In order to capture the effects of the time derivative as well, we need to continue the computation and construct the second-order correctors.

### Second-order corrector

Plugging the expansions (4.13) into the equation (4.10)–(4.11) and collecting the terms of order  $\epsilon^2$ , we get the equation for the first component of the velocity second-order corrector  $V_2^1$ :

$$\begin{aligned} \frac{\partial V_0^1}{\partial t} - \mu \left( \frac{\partial^2 V_0^1}{\partial x_1^2} + \Delta_{y'} V_2^1 + \kappa \cos \alpha \frac{\partial V_1^1}{\partial y_2} - \kappa \sin \alpha \frac{\partial V_1^1}{\partial y_3} - \kappa^2 V_0^1 + \kappa(e_\alpha \cdot y') \Delta_{y'} V_1^1 \right) \\ - \mu \left( \kappa(e_\alpha \cdot y') \left( -\kappa \cos \alpha \frac{\partial V_0^1}{\partial y_2} + \kappa \sin \alpha \frac{\partial V_0^1}{\partial y_3} \right) + \kappa^2 (e_\alpha \cdot y')^2 \Delta_{y'} V_0^1 \right) \\ + \kappa^2 (e_\alpha \cdot y')^2 \frac{\partial P_0}{\partial x_1} + \kappa(e_\alpha \cdot y') \frac{\partial P_1}{\partial x_1} + \frac{\partial P_2}{\partial x_1} = a \left( \frac{\partial W_1^3}{\partial y_2} - \frac{\partial W_1^2}{\partial y_3} \right). \end{aligned} \quad (4.32)$$

Inserting the expressions for  $V_0^1, V_1^1, P_0, P_1, P_2, W_1^2$  and  $W_1^3$  given by (4.15)–(4.18), (4.19), (4.23), (4.26) and (4.31) into (4.32) yields

$$\begin{aligned} \Delta_{y'} V_2^1 &= A^1 y_2^2 + A^2 y_2 y_3 + A^3 y_3^2 + A^4 \text{ in } \Omega, \\ V_2^1 &= 0 \text{ on } \Gamma, \end{aligned} \quad (4.33)$$

where the functions  $A^1(x_1, t), \dots, A^4(x_1, t)$  are provided in the Appendix (see (C.5)).

The solution of (4.33) is given in the form

$$V_2^1(x_1, y', t) = (|y'|^2 - 1) \left( B^1 y_2^2 + B^2 y_2 y_3 + B^3 y_3^2 + B^4 \right),$$

where

$$\begin{aligned} B^1(x_1, t) &= \frac{7A^1 - A^3}{96}, \quad B^2(x_1, t) = \frac{1}{12} A^2, \\ B^3(x_1, t) &= \frac{7A^3 - A^1}{96}, \quad B^4(x_1, t) = \frac{1}{4} A^4 + \frac{1}{32} (A^1 + A^3). \end{aligned}$$

It is important to notice that the effects of the time derivative appear in the second-order corrector as the derivative of the flux function  $F_0^*(t)$  (see (C.5)).

In a similar way, we now obtain the equations for the second and third component of the velocity second-order corrector  $\mathbf{V}_2^* = (V_2^2, V_2^3)$ :

$$\begin{aligned}
 & -\mu \left( \Delta_{y'} V_2^2 - \kappa \cos \alpha \frac{\partial V_1^2}{\partial y_2} + \kappa \sin \alpha \frac{\partial V_1^2}{\partial y_3} + \left( 2\kappa \frac{\partial V_0^1}{\partial x_1} + \kappa' V_0^1 \right) \cos \alpha + \kappa \tau V_0^1 \sin \alpha \right) + \frac{\partial P_3}{\partial y_2} \\
 & \quad = a \left( \frac{\partial W_1^1}{\partial y_3} + \kappa (e_\alpha \cdot y') \frac{\partial W_0^1}{\partial y_3} - \frac{\partial W_0^3}{\partial x_1} \right) \text{ in } \Omega, \\
 & -\mu \left( \Delta_{y'} V_2^3 + \kappa \sin \alpha \frac{\partial V_1^3}{\partial y_3} - \kappa \cos \alpha \frac{\partial V_1^3}{\partial y_2} + \kappa \tau V_0^1 \cos \alpha - \left( 2\kappa \frac{\partial V_0^1}{\partial x_1} + \kappa' V_0^1 \right) \sin \alpha \right) + \frac{\partial P_3}{\partial y_3} \\
 & \quad = a \left( \frac{\partial W_0^2}{\partial x_1} - \frac{\partial W_1^1}{\partial y_2} - \kappa (e_\alpha \cdot y') \frac{\partial W_0^1}{\partial y_2} \right) \text{ in } \Omega, \\
 & \frac{\partial V_2^2}{\partial y_2} + \frac{\partial V_2^3}{\partial y_3} = -\frac{\partial V_1^1}{\partial x_1} + \kappa (V_1^2 \cos \alpha - V_1^3 \sin \alpha) - (\kappa' (e_\alpha \cdot y') + \kappa \tau (e_\alpha^\perp \cdot y')) V_0^1 \neq 0 \text{ in } \Omega, \\
 & \quad V_2^2 = V_2^3 = 0 \text{ on } \Gamma. \tag{4.34}
 \end{aligned}$$

The system of equations (4.34) admits a unique solution since

$$\int_B \left( -\frac{\partial V_1^1}{\partial x_1} + \kappa (V_1^2 \cos \alpha - V_1^3 \sin \alpha) - (\kappa' (e_\alpha \cdot y') + \kappa \tau (e_\alpha^\perp \cdot y')) V_0^1 \right) dB = 0,$$

(see [14]). The explicit solution is constructed below.

Inserting the expressions for  $V_0^1, W_0^1, W_0^2, W_0^3, V_1^1 V_1^2, V_1^3, W_1^1$  given by (4.19), (4.20), (4.23), (4.26) and (4.29) into (4.34), we get:

$$\begin{aligned}
 & -\mu \Delta_{y'} V_2^2 + \frac{\partial P_3}{\partial y_2} = A^5 y_2^2 + A^6 y_2 y_3 + A^7 y_3^2 + A^8, \\
 & -\mu \Delta_{y'} V_2^3 + \frac{\partial P_3}{\partial y_3} = A^9 y_2^2 + A^{10} y_2 y_3 + A^{11} y_3^2 + A^{12}, \\
 & \frac{\partial V_2^2}{\partial y_2} + \frac{\partial V_2^3}{\partial y_3} = A^{13} y_2^3 + A^{14} y_3^3 + A^{13} y_2 y_3^2 + A^{14} y_2^2 y_3 - A^{13} y_2 - A^{14} y_3, \\
 & \quad V_2^2 = V_2^3 = 0 \text{ on } \Gamma, \tag{4.35}
 \end{aligned}$$

where  $A^5(x_1, t), \dots, A^{14}(x_1, t)$  are given in the Appendix (see (C.6)).

We seek the solution of (4.35) in the following form:

$$\begin{aligned}
 & V_2^2(x_1, y', t) = (1 - |y'|^2)(B^5 y_2^2 + B^6 y_2 y_3 + B^7 y_3^2 + B^8), \\
 & V_2^3(x_1, y', t) = (1 - |y'|^2)(B^9 y_2^2 + B^{10} y_2 y_3 + B^{11} y_3^2 + B^{12}), \\
 & P_3(x_1, y', t) = M^1 y_2^3 + M^2 y_3^3 + M^3 y_2 y_3^2 + M^4 y_2^2 y_3 + M^5 y_2 + M^6 y_3. \tag{4.36}
 \end{aligned}$$

Plugging (4.36) into the system (4.35), we obtain a system of equations relating  $B^5(x_1, t), \dots, B^{12}(x_1, t)$  and  $M^1(x_1, t), \dots, M^6(x_1, t)$  with  $A^5(x_1, t), \dots, A^{14}(x_1, t)$ . Solving this system, we deduce  $B^5(x_1, t), \dots, B^{12}(x_1, t)$  and  $M^1(x_1, t), \dots, M^6(x_1, t)$  (see (C.7)–(C.8) in the Appendix).

In this way, we have obtained the explicit expressions for the velocity second order corrector  $(V_2^2, V_2^3)$  and pressure third-order corrector  $P_3$  and we now compute the microrotation second-order corrector in the following.

Substituting (4.13) into (4.12) and collecting the  $\epsilon^2$  terms, we obtain the following problem for the first component of the microrotation second-order corrector  $W_2^1$ :

$$\begin{aligned}
 & \frac{\partial W_0^1}{\partial t} - \delta \left( \frac{\partial^2 W_0^1}{\partial x_1^2} + \Delta_{y'} W_2^1 + \kappa \cos \alpha \left( \frac{\partial W_1^1}{\partial y_2} - \frac{\partial W_0^2}{\partial x_1} \right) + \kappa \sin \alpha \left( \frac{\partial W_0^3}{\partial x_1} - \frac{\partial W_1^1}{\partial y_3} \right) \right) \\
 & \quad - \delta \frac{\partial}{\partial x_1} \left( W_0^2 \kappa \cos \alpha - W_0^3 \kappa \sin \alpha \right) + \delta \kappa^2 W_0^1 \\
 & \quad - \delta \kappa (e_\alpha \cdot y') \left( \Delta_{y'} W_1^1 - \kappa \cos \alpha \frac{\partial W_0^1}{\partial y_2} + \kappa \sin \alpha \frac{\partial W_0^1}{\partial y_3} \right) - \delta \kappa^2 (e_\alpha \cdot y')^2 \Delta_{y'} W_0^1 \\
 & \quad - \beta \left( \frac{\partial^2 W_0^1}{\partial x_1^2} - (\kappa \cos \alpha)' W_0^2 - \kappa \cos \alpha \frac{\partial W_0^2}{\partial x_1} + (\kappa \sin \alpha)' W_0^3 \right) \\
 & \quad - \beta \left( \kappa \sin \alpha \frac{\partial W_0^3}{\partial x_1} + \frac{\partial^2 W_1^2}{\partial x_1 \partial y_2} + \frac{\partial^2 W_1^3}{\partial x_1 \partial y_3} \right) \\
 & \quad - \beta \left( \kappa (e_\alpha \cdot y') \frac{\partial^2 W_0^2}{\partial x_1 \partial y_2} + \kappa (e_\alpha \cdot y') \frac{\partial W_0^3}{\partial x_1 \partial y_3} \right) + 2a W_0^1 = a \left( \frac{\partial V_1^3}{\partial y_2} - \frac{\partial V_1^2}{\partial y_3} \right) \text{ in } \Omega, \\
 & \quad W_2^1 = 0 \text{ on } \Gamma.
 \end{aligned} \tag{4.37}$$

Inserting the expressions for  $W_0^1, W_0^2, W_0^3, V_1^2, V_1^3, W_1^1, W_1^2, W_1^3$  given by (4.20), (4.26), (4.29) and (4.31) into (4.37) yields

$$\begin{aligned}
 \Delta_{y'} W_2^1 &= C^1 y_2^2 + C^2 y_2 y_3 + C^3 y_3^2 + C^4 \text{ in } \Omega, \\
 W_2^1 &= 0 \text{ on } \Gamma,
 \end{aligned} \tag{4.38}$$

where the functions  $C^1(x_1, t), \dots, C^4(x_1, t)$  are given in the Appendix (see (C.9)).

We find the solution of the problem (4.38) in the form

$$W_2^1(x_1, y', t) = (|y'|^2 - 1)(D^1 y_2^2 + D^2 y_2 y_3 + D^3 y_3^2 + D^4), \tag{4.39}$$

where

$$D^1 = \frac{7C^1 - C^3}{96}, \quad D^2 = \frac{1}{12} C^2, \quad D^3 = \frac{7C^3 - C^1}{96}, \quad D^4 = \frac{1}{4} C^4 + \frac{1}{32} (C^1 + C^3). \tag{4.40}$$



Plugging expansions (4.13) into equation (4.12) and collecting the  $\epsilon^2$  terms, we finally obtain the problem for the second and third component of the microrotation second-order corector  $(W_2^2, W_2^3)$  as:

$$\begin{aligned}
 & \frac{\partial W_0^2}{\partial t} - \delta \left( \frac{\partial^2 W_0^2}{\partial x_1^2} + \Delta_{y'} W_2^2 - \kappa \cos \alpha \frac{\partial W_1^2}{\partial y_2} + \kappa \sin \alpha \frac{\partial W_1^2}{\partial y_3} - 2\kappa^2 (e_\alpha \cdot y') \cos \alpha \frac{\partial W_0^2}{\partial y_2} \right) \\
 & - \delta \left( 2\kappa^2 (e_\alpha \cdot y') \sin \alpha \frac{\partial W_0^2}{\partial y_3} + \left( 2\kappa \frac{\partial W_0^1}{\partial x_1} + \kappa' W_0^1 - \kappa^2 W_0^2 \right) \cos \alpha + \kappa \tau W_0^1 \sin \alpha \right) \\
 & - \delta \left( \kappa^2 \cos \alpha (e_\alpha \cdot y') \frac{\partial W_0^2}{\partial y_2} - \kappa^2 \sin \alpha (e_\alpha \cdot y') \frac{\partial W_0^2}{\partial y_3} \right) - \beta \frac{\partial^2 W_1^1}{\partial x_1 \partial y_2} \\
 & - \beta \left( -\kappa \left( \frac{\partial W_1^2}{\partial y_2} \cos \alpha - \frac{\partial W_1^2}{\partial y_3} \sin \alpha \right) + (\kappa' W_0^1 + \kappa^2 \cos \alpha W_0^2 - \kappa^2 \sin \alpha W_0^3) \cos \alpha \right) \\
 & - 2\beta \kappa \left( \frac{\partial W_0^1}{\partial x_1} - \kappa (W_0^2 \cos \alpha - W_0^3 \sin \alpha) \right) \cos \alpha - \beta \left( \kappa \tau W_0^1 \sin \alpha + \kappa' (e_\alpha \cdot y') \frac{\partial W_0^1}{\partial y_2} \right) \\
 & - \beta \kappa \tau (e_\alpha^\perp \cdot y') \frac{\partial W_0^1}{\partial y_2} - \beta \kappa^2 (e_\alpha \cdot y') \left( \frac{\partial W_0^2}{\partial y_2} \cos \alpha - \frac{\partial W_0^3}{\partial y_3} \sin \alpha \right) - \beta \left( \frac{\partial^2 W_2^2}{\partial y_2^2} + \frac{\partial^2 W_2^3}{\partial y_2 \partial y_3} \right) \\
 & - 2\beta \kappa (e_\alpha \cdot y') \left( \frac{\partial^2 W_0^1}{\partial x_1 \partial y_2} - \kappa \left( \frac{\partial W_0^2}{\partial y_2} \cos \alpha - \frac{\partial W_0^3}{\partial y_2} \sin \alpha \right) \right) + 2a W_0^2 \\
 & = a \left( \frac{\partial V_1^1}{\partial y_3} + \kappa (e_\alpha \cdot y') \frac{\partial V_0^1}{\partial y_3} - \frac{\partial V_0^3}{\partial x_1} \right) \text{ in } \Omega, \\
 \\
 & \frac{\partial W_0^3}{\partial t} - \delta \left( \frac{\partial^2 W_0^3}{\partial x_1^2} + \Delta_{y'} W_2^3 + \kappa \sin \alpha \frac{\partial W_1^3}{\partial y_3} - \kappa \cos \alpha \frac{\partial W_1^3}{\partial y_2} + 2\kappa^2 (e_\alpha \cdot y') \sin \alpha \frac{\partial W_0^3}{\partial y_3} \right) \\
 & - \delta \left( -2\kappa^2 (e_\alpha \cdot y') \cos \alpha \frac{\partial W_0^3}{\partial y_2} + \kappa \tau W_0^1 \cos \alpha - \left( 2\kappa \frac{\partial W_0^1}{\partial x_1} + \kappa' W_0^1 - \kappa^2 W_0^2 \right) \sin \alpha \right) \\
 & - \delta \left( \kappa^2 \cos \alpha (e_\alpha \cdot y') \frac{\partial W_0^3}{\partial y_2} - \kappa^2 \sin \alpha (e_\alpha \cdot y') \frac{\partial W_0^3}{\partial y_3} \right) - \beta \frac{\partial^2 W_1^1}{\partial x_1 \partial y_3} \\
 & - \beta \left( -\kappa \left( \frac{\partial W_1^2}{\partial y_3} \cos \alpha - \frac{\partial W_1^3}{\partial y_3} \sin \alpha \right) + \kappa \tau W_0^1 \cos \alpha \right) \\
 & + \beta \left( \kappa' W_0^1 + \kappa^2 \cos \alpha W_0^2 - \kappa^2 \sin \alpha W_0^3 \right) \\
 & - 2\beta \kappa \left( \frac{\partial W_0^1}{\partial x_1} - \kappa (W_0^2 \cos \alpha - W_0^3 \sin \alpha) \right) \sin \alpha - \beta \left( \kappa' (e_\alpha \cdot y') \frac{\partial W_0^1}{\partial y_3} + \kappa \tau (e_\alpha^\perp \cdot y') \frac{\partial W_0^1}{\partial y_3} \right) \\
 & - \beta \kappa^2 (e_\alpha \cdot y') \left( \cos \alpha \frac{\partial W_0^2}{\partial y_3} - \sin \alpha \frac{\partial W_0^3}{\partial y_3} \right) - \beta \left( \frac{\partial^2 W_2^3}{\partial y_3^2} + \frac{\partial^2 W_2^2}{\partial y_2 \partial y_3} \right) \\
 & - 2\beta \kappa (e_\alpha \cdot y') \left( \frac{\partial^2 W_0^1}{\partial x_1 \partial y_3} - \kappa \left( \frac{\partial W_0^2}{\partial y_3} \cos \alpha - \frac{\partial W_0^3}{\partial y_3} \sin \alpha \right) \right) + 2a W_0^3 \\
 & = a \left( \frac{\partial V_0^2}{\partial x_1} - \frac{\partial V_1^1}{\partial y_2} - \kappa (e_\alpha \cdot y') \frac{\partial V_0^1}{\partial y_2} \right) \text{ in } \Omega, \\
 & W_2^2 = W_2^3 = 0 \text{ on } \Gamma. \tag{4.41}
 \end{aligned}$$

Plugging the expressions for  $V_0^1, V_0^2, V_0^3, V_1^1, W_0^1, W_0^2, W_0^3, W_1^1, W_1^2, W_1^3$  given by (4.15), (4.19), (4.20), (4.23), (4.29) and (4.31) into (4.41) yields:

$$\begin{aligned}
 -\delta\left(\frac{\partial^2 W_2^2}{\partial y_2^2} + \frac{\partial^2 W_2^2}{\partial y_3^2}\right) - \beta\left(\frac{\partial^2 W_2^2}{\partial y_2^2} + \frac{\partial^2 W_2^3}{\partial y_2 \partial y_3}\right) &= C^5 y_2^2 + C^6 y_2 y_3 + C^7 y_3^2 + C^8 \text{ in } \Omega, \\
 -\delta\left(\frac{\partial^2 W_2^3}{\partial y_2^2} + \frac{\partial^2 W_2^3}{\partial y_3^2}\right) - \beta\left(\frac{\partial^2 W_2^2}{\partial y_2 \partial y_3} + \frac{\partial^2 W_2^3}{\partial y_3^2}\right) &= C^9 y_2^2 + C^{10} y_2 y_3 + C^{11} y_3^2 + C^{12} \text{ in } \Omega, \\
 W_2^2 = W_2^3 &= 0 \text{ on } \Gamma.
 \end{aligned} \tag{4.42}$$

The functions  $C^5(x_1, t), \dots, C^{12}(x_1, t)$  are given in the Appendix (see (C.10)–(C.11)).

The solution of the problem (4.42) takes the following form

$$\begin{aligned}
 W_2^2(x_1, y', t) &= (|y'|^2 - 1)(D^5 y_2^2 + D^6 y_2 y_3 + D^7 y_3^2 + D^8), \\
 W_2^3(x_1, y', t) &= (|y'|^2 - 1)(D^9 y_2^2 + D^{10} y_2 y_3 + D^{11} y_3^2 + D^{12}),
 \end{aligned} \tag{4.43}$$

where  $D^5(x_1, t), \dots, D^{12}(x_1, t)$  can be found in the Appendix (see (C.12)).

To conclude this subsection, we notice that the expressions for  $(W_2^1, W_2^2, W_2^3)$  given by (4.39)–(4.40) and (4.43) contain the effects of the time derivative of the external force function  $\mathbf{g}$ .

### 4.3.2 Boundary Layer

The regular part of our expansion

$$\begin{aligned}
 \mathbf{U}_{\epsilon, [2]}^{reg}(x, t) &= \epsilon^2 \mathbf{V}_0\left(\frac{x'}{\epsilon}, t\right) + \epsilon^3 \mathbf{V}_1\left(x_1, \frac{x'}{\epsilon}, t\right) + \epsilon^4 \mathbf{V}_2\left(x_1, \frac{x'}{\epsilon}, t\right), \\
 \mathbf{V}_j &= V_j^1 \mathbf{a}^1 + V_j^2 \mathbf{a}^2 + V_j^3 \mathbf{a}^3, \quad j = 0, 1, 2, \\
 \mathbf{W}_{\epsilon, [2]}^{reg}(x, t) &= \epsilon^2 \mathbf{W}_0\left(x_1, \frac{x'}{\epsilon}, t\right) + \epsilon^3 \mathbf{W}_1\left(x_1, \frac{x'}{\epsilon}, t\right) + \epsilon^4 \mathbf{W}_2\left(x_1, \frac{x'}{\epsilon}, t\right), \\
 \mathbf{W}_j &= W_j^1 \mathbf{a}^1 + W_j^2 \mathbf{a}^2 + W_j^3 \mathbf{a}^3, \quad j = 0, 1, 2, \\
 P_{\epsilon, [3]}^{reg}(x, t) &= P_0(x_1, t) + \epsilon P_1\left(x_1, \frac{x'}{\epsilon}, t\right) + \epsilon^2 P_2\left(x_1, \frac{x'}{\epsilon}, t\right) + \epsilon^3 P_3\left(x_1, \frac{x'}{\epsilon}, t\right),
 \end{aligned} \tag{4.44}$$

has been computed to satisfy the governing equations and the lateral boundary conditions, while the boundary conditions at the ends of the pipe have been neglected in the process.

To fix that, we introduce the boundary layer correctors at  $x_1 = 0$ :

$$\begin{aligned}
 \mathbf{U}_{\epsilon,[2]}^{bl,0}(x,t) &= \epsilon^2 \mathbf{V}_0\left(\frac{x_1}{\epsilon}, \frac{x'}{\epsilon}, t\right) + \epsilon^3 \mathbf{V}_1\left(\frac{x_1}{\epsilon}, \frac{x'}{\epsilon}, t\right) + \epsilon^4 \mathbf{V}_2\left(\frac{x_1}{\epsilon}, \frac{x'}{\epsilon}, t\right), \\
 \mathbf{V}_j &= \mathcal{V}_j^1 \mathbf{a}^1 + \mathcal{V}_j^2 \mathbf{a}^2 + \mathcal{V}_j^3 \mathbf{a}^3, \quad j = 0, 1, 2, \\
 \mathbf{W}_{\epsilon,[2]}^{bl,0}(x,t) &= \epsilon^2 \mathbf{W}_0\left(\frac{x_1}{\epsilon}, \frac{x'}{\epsilon}, t\right) + \epsilon^3 \mathbf{W}_1\left(\frac{x_1}{\epsilon}, \frac{x'}{\epsilon}, t\right) + \epsilon^4 \mathbf{W}_2\left(\frac{x_1}{\epsilon}, \frac{x'}{\epsilon}, t\right), \\
 \mathbf{W}_j &= \mathcal{W}_j^1 \mathbf{a}^1 + \mathcal{W}_j^2 \mathbf{a}^2 + \mathcal{W}_j^3 \mathbf{a}^3, \quad j = 0, 1, 2, \\
 P_{\epsilon,[2]}^{bl,0}(x,t) &= \epsilon \mathcal{P}_0\left(\frac{x_1}{\epsilon}, \frac{x'}{\epsilon}, t\right) + \epsilon^2 \mathcal{P}_1\left(\frac{x_1}{\epsilon}, \frac{x'}{\epsilon}, t\right) + \epsilon^3 \mathcal{P}_2\left(\frac{x_1}{\epsilon}, \frac{x'}{\epsilon}, t\right),
 \end{aligned} \tag{4.45}$$

and the boundary layer correctors on the opposite side  $x_1 = l$ :

$$\begin{aligned}
 \mathbf{U}_{\epsilon,[2]}^{bl,l}(x,t) &= \epsilon^2 \mathbf{Y}_0\left(\frac{x_1-l}{\epsilon}, \frac{x'}{\epsilon}, t\right) + \epsilon^3 \mathbf{Y}_1\left(\frac{x_1-l}{\epsilon}, \frac{x'}{\epsilon}, t\right) + \epsilon^4 \mathbf{Y}_2\left(\frac{x_1-l}{\epsilon}, \frac{x'}{\epsilon}, t\right), \\
 \mathbf{Y}_j &= \mathcal{Y}_j^1 \mathbf{a}^1 + \mathcal{Y}_j^2 \mathbf{a}^2 + \mathcal{Y}_j^3 \mathbf{a}^3, \quad j = 0, 1, 2, \\
 \mathbf{W}_{\epsilon,[2]}^{bl,l}(x,t) &= \epsilon^2 \mathbf{Z}_0\left(\frac{x_1-l}{\epsilon}, \frac{x'}{\epsilon}, t\right) + \epsilon^3 \mathbf{Z}_1\left(\frac{x_1-l}{\epsilon}, \frac{x'}{\epsilon}, t\right) + \epsilon^4 \mathbf{Z}_2\left(\frac{x_1-l}{\epsilon}, \frac{x'}{\epsilon}, t\right), \\
 \mathbf{Z}_j &= \mathcal{Z}_j^1 \mathbf{a}^1 + \mathcal{Z}_j^2 \mathbf{a}^2 + \mathcal{Z}_j^3 \mathbf{a}^3, \quad j = 0, 1, 2, \\
 P_{\epsilon,[2]}^{bl,l}(x,t) &= \epsilon \mathcal{Q}_0\left(\frac{x_1-l}{\epsilon}, \frac{x'}{\epsilon}, t\right) + \epsilon^2 \mathcal{Q}_1\left(\frac{x_1-l}{\epsilon}, \frac{x'}{\epsilon}, t\right) + \epsilon^3 \mathcal{Q}_2\left(\frac{x_1-l}{\epsilon}, \frac{x'}{\epsilon}, t\right).
 \end{aligned} \tag{4.46}$$

The boundary layer correctors at  $x_1 = 0$  given by (4.45) are defined on the semi-infinite cylinder  $\mathcal{G}_0 = \langle 0, \infty \rangle \times B$ , whereas the boundary layer correctors at  $x_1 = l$  given by (4.46) are defined on  $\mathcal{G}_l = \langle -\infty, 0 \rangle \times B$ .

It should be emphasized that, due to (4.7), the homogeneous initial conditions (4.2)<sub>3</sub> are automatically satisfied and for this reason the boundary layer in time does not appear.

## Boundary Layer for Velocity and Pressure

### *Zero-order Approximation*

Substituting the boundary layer correctors (4.45) into the equations (4.10)–(4.11) and collecting the  $\epsilon^0$  terms, we obtain the problem for the velocity and pressure zero-order boundary layer approximation at  $x_1 = 0$ :

$$\begin{aligned}
 -\mu \Delta \mathbf{V}_0 + \nabla \mathcal{P}_0 &= \mathbf{0} \quad \text{in } \mathcal{G}_0, \\
 \operatorname{div} \mathbf{V}_0 &= 0 \quad \text{in } \mathcal{G}_0, \quad \mathbf{V}_0 = \mathbf{0} \quad \text{on } \omega = \langle 0, \infty \rangle \times \partial B, \\
 (\mathcal{V}_0^1(0, \cdot, t), \mathcal{V}_0^2(0, \cdot, t), \mathcal{V}_0^3(0, \cdot, t)) &= (h_0^t - V_0^1(0, \cdot, t), h_0^n \cos \alpha(0) + h_0^b \sin \alpha(0), \\
 &\quad h_0^b \cos \alpha(0) - h_0^n \sin \alpha(0)).
 \end{aligned} \tag{4.47}$$

System (4.47) admits a unique (up to an additive constant in the pressure) solution  $\mathbf{v}_0(\cdot, t) \in W^{1,2}(\mathcal{G}_0)^3$ ,  $\mathcal{P}_0(\cdot, t) \in L^2_{loc}(\mathcal{G}_0)$  since the necessary compatibility conditions holds

$$\int_B \left( h_0^t - V_0^1(0, \cdot, t) \right) = F_0^*(t) - F_0^*(t) = 0.$$

It is also well known that these functions in some sense exponentially decay as  $y_1 \rightarrow \infty$  (see e.g. [14]).

The problem for the velocity and pressure zero-order boundary layer approximations at  $x_1 = l$  given by (4.46) is analogous as for  $(\mathbf{v}_0, \mathcal{P}_0)$  :

$$\begin{aligned} -\mu \Delta \mathbf{y}_0 + \nabla \mathcal{Q}_0 &= \mathbf{0} \quad \text{in } \mathcal{G}_l, \\ \operatorname{div} \mathbf{y}_0 &= 0 \quad \text{in } \mathcal{G}_l, \quad \mathbf{y}_0 = \mathbf{0} \quad \text{on } \sigma = \langle -\infty, 0 \rangle \times \partial B, \\ (\mathcal{Y}_0^1(0, \cdot, t), \mathcal{Y}_0^2(0, \cdot, t), \mathcal{Y}_0^3(0, \cdot, t)) &= (h_l^t - V_0^1(l, \cdot, t), h_l^n \cos \alpha(l) + h_l^b \sin \alpha(l), \\ &\quad h_l^b \cos \alpha(l) - h_l^n \sin \alpha(l)). \end{aligned} \tag{4.48}$$

The well-posedness and the exponential decay of the solution  $(\mathbf{y}_0, \mathcal{Q}_0)$  follow analogously as for  $(\mathbf{v}_0, \mathcal{P}_0)$ .

*First-order corrector*

The first-order boundary layer correctors at  $x_1 = 0$  for the velocity and pressure  $(\mathbf{v}_1, \mathcal{P}_1)$  are given as the solution of the following problem:

$$\begin{aligned} -\mu \Delta \mathbf{v}_1 + \nabla \mathcal{P}_1 &= \Xi(0, t, \mathbf{v}_0, \mathbf{w}_0, \mathcal{P}_0) \quad \text{in } \mathcal{G}_0, \\ \operatorname{div} \mathbf{v}_1 &= \kappa(0) \cos \alpha(0) \mathcal{V}_0^2 - \kappa(0) \sin \alpha(0) \mathcal{V}_0^3 \\ &\quad - \left( 2\kappa(0) \cos \alpha(0) y_2 \frac{\partial \mathcal{V}_0^1}{\partial y_1} - 2\kappa(0) \sin \alpha(0) y_3 \frac{\partial \mathcal{V}_0^1}{\partial y_1} \right), \\ \mathbf{v}_1 &= \mathbf{0} \quad \text{on } \omega = \langle 0, \infty \rangle \times \partial B, \\ (\mathcal{V}_1^1(0, \cdot, t), \mathcal{V}_1^2(0, \cdot, t), \mathcal{V}_1^3(0, \cdot, t)) &= -(V_1^1(0, \cdot, t), V_1^2(0, \cdot, t), V_1^3(0, \cdot, t)) \\ &\quad - (\kappa(0)(e_\alpha(0) \cdot y') V_0^1(0, \cdot, t), 0, 0) - (\kappa(0)(e_\alpha(0) \cdot y') \mathcal{V}_0^1(0, \cdot, t), 0, 0), \end{aligned} \tag{4.49}$$

where  $\Xi(x_1, t, \mathbf{J}, \mathbf{K}, j)$  is an exponentially decreasing function provided in the Appendix (see (C.13)).

To ensure the well-posedness of the problem (4.49), we need to verify the compatibility condition

$$\int_{\mathcal{G}_0} \operatorname{div} \mathbf{v}_1 = - \int_B \mathcal{V}_1^1(0, \cdot, t). \tag{4.50}$$

Since

$$\operatorname{div}(y_2 \mathbf{v}_0) = \mathcal{V}_0^2, \quad \operatorname{div}(y_3 \mathbf{v}_0) = \mathcal{V}_0^3,$$

we obtain

$$\begin{aligned}\int_{\mathcal{G}_0} \mathcal{V}_0^2 &= - \int_B y_2 \mathcal{V}_0^1(0, \cdot, t) = \int_B y_2 (V_0^1 - h_0^t) = - \int_B y_2 h_0^t, \\ \int_{\mathcal{G}_0} \mathcal{V}_0^3 &= - \int_B y_3 \mathcal{V}_0^1(0, \cdot, t) = \int_B y_3 (V_0^1 - h_0^t) = - \int_B y_3 h_0^t,\end{aligned}$$

yielding

$$\begin{aligned}\int_{\mathcal{G}_0} \operatorname{div} \mathbf{v}_1 &= \kappa(0) \cos \alpha(0) \int_{\mathcal{G}_0} \mathcal{V}_0^2 - \kappa(0) \sin \alpha(0) \int_{\mathcal{G}_0} \mathcal{V}_0^3 \\ &\quad - 2\kappa(0) \cos \alpha(0) \int_{\mathcal{G}_0} y_2 \frac{\partial \mathcal{V}_0^1}{\partial y_1} + 2\kappa(0) \sin \alpha(0) \int_{\mathcal{G}_0} y_3 \frac{\partial \mathcal{V}_0^1}{\partial y_1} \\ &= -\kappa(0) \cos \alpha(0) \int_B y_2 h_0^t + \kappa(0) \sin \alpha(0) \int_B y_3 h_0^t \\ &\quad - 2\kappa(0) \cos \alpha(0) \int_{\mathcal{G}_0} y_2 \frac{\partial \mathcal{V}_0^1}{\partial y_1} + 2\kappa(0) \sin \alpha(0) \int_{\mathcal{G}_0} y_3 \frac{\partial \mathcal{V}_0^1}{\partial y_1}.\end{aligned}$$

On the other hand, we have

$$\begin{aligned}\int_B \mathcal{V}_1^1(0, \cdot, t) &= - \int_B V_1^1(0, \cdot, t) - \kappa(0) \cos \alpha(0) \int_B y_2 V_0^1(0, \cdot, t) \\ &\quad + \kappa(0) \sin \alpha(0) \int_B y_3 V_0^1(0, \cdot, t) - \kappa(0) \cos \alpha(0) \int_B y_2 (h_0^t - V_0^1(0, \cdot, t)) \\ &\quad + \kappa(0) \sin \alpha(0) \int_B y_3 (h_0^t - V_0^1(0, \cdot, t)) \\ &= -\kappa(0) \cos \alpha(0) \int_B y_2 h_0^t + \kappa(0) \sin \alpha(0) \int_B y_3 h_0^t,\end{aligned}$$

and, in order to satisfy the compatibility condition (4.50), we need to verify the following identity:

$$\begin{aligned}- 2\kappa(0) \cos \alpha(0) \int_{\mathcal{G}_0} y_2 \frac{\partial \mathcal{V}_0^1}{\partial y_1} + 2\kappa(0) \sin \alpha(0) \int_{\mathcal{G}_0} y_3 \frac{\partial \mathcal{V}_0^1}{\partial y_1} \\ = 2\kappa(0) \cos \alpha(0) \int_B y_2 h_0^t - 2\kappa(0) \sin \alpha(0) \int_B y_3 h_0^t.\end{aligned}\tag{4.51}$$

Using the fact that  $\mathcal{V}_0^1$  exponentially decays as  $y_1 \rightarrow \infty$ , we have:

$$\begin{aligned}\int_{\mathcal{G}_0} y_2 \frac{\partial \mathcal{V}_0^1}{\partial y_1} &= \int_B y_2 \lim_{a \rightarrow \infty} \int_0^a \frac{\partial \mathcal{V}_0^1}{\partial y_1} = \int_B y_2 \lim_{a \rightarrow \infty} (\mathcal{V}_0^1(a, \cdot, t) - \mathcal{V}_0^1(0, \cdot, t)) \\ &= - \int_B y_2 (h_0^t - V_0^1(0, \cdot, t)) = - \int_B y_2 h_0^t,\end{aligned}$$

and

$$\int_{\mathcal{G}_0} y_3 \frac{\partial \mathcal{V}_0^1}{\partial y_1} = - \int_B y_3 h_0^t,$$

thus verifying the compatibility condition (4.51). Consequently, the well-posedness of the problem (4.49) is established. Notice that  $(\mathbf{v}_1, \mathcal{P}_1)$  exponentially decay as  $y_1 \rightarrow \infty$  since

$\Xi$  is an exponentially decreasing function in  $y_1$  (see [14]).

The existence of the exponentially decaying unique solution corresponding to the problem on the opposite side  $x_1 = l$  for the first-order boundary layer correctors  $(\mathbf{V}_1, \mathcal{Q}_1)$  follows in a similar manner.

### Second-order corrector

The second-order boundary layer correctors at  $x_1 = 0$  for the velocity and pressure  $(\mathbf{V}_2, \mathcal{P}_2)$  are given by:

$$\begin{aligned}
 & -\mu\Delta\mathbf{V}_2 + \nabla\mathcal{P}_2 = \Pi(0, t, \mathbf{V}_0, \mathbf{V}_1, \mathbf{W}_0, \mathbf{W}_1, \mathcal{P}_0, \mathcal{P}_1) \text{ in } \mathcal{G}_0, \\
 \operatorname{div}\mathbf{V}_2 &= \kappa(0)\cos\alpha(0)\mathcal{V}_1^2 - \kappa(0)\sin\alpha(0)\mathcal{V}_1^3 - (\kappa'(0)(e_\alpha(0) \cdot y') + \kappa(0)\tau(0)(e_\alpha^\perp(0) \cdot y'))\mathcal{V}_0^1 \\
 & - \kappa^2(0)(e_\alpha(0) \cdot y')\cos\alpha(0)\mathcal{V}_0^2 + \kappa^2(0)(e_\alpha(0) \cdot y')\sin\alpha(0)\mathcal{V}_0^3 \\
 & + 2\kappa(0)(e_\alpha(0) \cdot y')(\kappa(0)\cos\alpha(0)\mathcal{V}_0^2 - \kappa(0)\sin\alpha(0)\mathcal{V}_0^3) \\
 & - 2\kappa(0)(e_\alpha(0) \cdot y')\frac{\partial\mathcal{V}_1^1}{\partial y_1} - 3\kappa^2(0)(e_\alpha(0) \cdot y')^2\frac{\partial\mathcal{V}_0^1}{\partial y_1} \text{ in } \mathcal{G}_0, \\
 \mathbf{V}_2 &= \mathbf{0} \text{ in } \omega = \langle 0, \infty \rangle \times \partial B, \\
 (\mathcal{V}_2^1(0, \cdot, t), \mathcal{V}_2^2(0, \cdot, t), \mathcal{V}_2^3(0, \cdot, t)) &= -(V_2^1(0, \cdot, t), V_2^2(0, \cdot, t), V_2^3(0, \cdot, t)) \\
 & - (\kappa(0)(e_\alpha(0) \cdot y')V_1^1(0, \cdot, t), 0, 0) - (\kappa^2(0)(e_\alpha(0) \cdot y')^2V_0^1(0, \cdot, t), 0, 0) \\
 & - (\kappa(0)(e_\alpha(0) \cdot y')\mathcal{V}_1^1(0, \cdot, t), 0, 0) - (\kappa^2(0)(e_\alpha(0) \cdot y')^2\mathcal{V}_0^1(0, \cdot, t), 0, 0),
 \end{aligned} \tag{4.52}$$

where  $\Pi(x_1, t, \mathbf{J}_0, \mathbf{J}_1, \mathbf{K}_0, \mathbf{K}_1, j_0, j_1)$  is an exponentially decreasing function given in the Appendix (see (C.14)).

To ensure the well-posedness of (4.52), we check the compatibility condition

$$\int_{\mathcal{G}_0} \operatorname{div}\mathbf{V}_2 = - \int_B \mathcal{V}_2^1(0, \cdot, t). \tag{4.53}$$

Using the relations

$$\begin{aligned}
 \mathcal{V}_1^2 &= \operatorname{div}(y_2\mathbf{V}_1) - \kappa(0)\cos\alpha(0)y_2\mathcal{V}_0^2 + \kappa(0)\sin\alpha(0)y_2\mathcal{V}_0^3 \\
 & + \left( 2\kappa(0)\cos\alpha(0)y_2^2\frac{\partial\mathcal{V}_0^1}{\partial y_1} - 2\kappa(0)\sin\alpha(0)y_2y_3\frac{\partial\mathcal{V}_0^1}{\partial y_1} \right), \\
 \mathcal{V}_1^3 &= \operatorname{div}(y_3\mathbf{V}_1) - \kappa(0)\cos\alpha(0)y_3\mathcal{V}_0^2 + \kappa(0)\sin\alpha(0)y_3\mathcal{V}_0^3 \\
 & + \left( 2\kappa(0)\cos\alpha(0)y_2y_3\frac{\partial\mathcal{V}_0^1}{\partial y_1} - 2\kappa(0)\sin\alpha(0)y_3^2\frac{\partial\mathcal{V}_0^1}{\partial y_1} \right),
 \end{aligned}$$

and integrating (4.52)<sub>2</sub> over  $\mathcal{G}_0$ , the first two terms can be written as:

$$\kappa(0)\cos\alpha(0)\int_{\mathcal{G}_0}\mathcal{V}_1^2 - \kappa(0)\sin\alpha(0)\int_{\mathcal{G}_0}\mathcal{V}_1^3$$

$$\begin{aligned}
 &= - \int_B \left( \kappa(0) \cos \alpha(0) y_2 - \kappa(0) \sin \alpha(0) y_3 \right) \mathcal{V}_1^1(0, \cdot, t) \\
 &+ 2\kappa^2(0) \cos^2 \alpha(0) \int_{\mathcal{G}_0} y_2^2 \frac{\partial \mathcal{V}_0^1}{\partial y_1} - 4\kappa(0) \sin \alpha \cos \alpha(0) \int_{\mathcal{G}_0} y_2 y_3 \frac{\partial \mathcal{V}_0^1}{\partial y_1} + 2\kappa^2(0) \sin^2(0) y_3^2 \frac{\partial \mathcal{V}_0^1}{\partial y_1} \\
 &= \int_B \left( \kappa(0) \cos \alpha(0) y_2 - \kappa(0) \sin \alpha(0) y_3 \right) \left( V_1^1(0, \cdot, t) + \kappa(0) (e_\alpha(0) \cdot y') h_0^t \right) \\
 &+ \int_B \left( 2\kappa^2(0) \cos^2 \alpha(0) y_2^2 - 4\kappa(0) \sin \alpha(0) \cos \alpha(0) y_2 y_3 \right) \left( V_0^1(0, \cdot, t) - h_0^t \right) \\
 &\quad + \int_B 2\kappa^2(0) \sin^2(0) y_3^2 \left( V_0^1(0, \cdot, t) - h_0^t \right),
 \end{aligned}$$

while other terms in the divergence equation can be written in the following way:

$$\begin{aligned}
 &- \int_{\mathcal{G}_0} \left( \left( \kappa'(0) \cos \alpha(0) + \kappa(0) \tau(0) \sin \alpha(0) \right) y_2 \right) \mathcal{V}_0^1 \\
 &- \int_{\mathcal{G}_0} \left( \left( -\kappa'(0) \sin \alpha(0) + \kappa(0) \tau(0) \cos \alpha(0) \right) y_3 \right) \mathcal{V}_0^1 \\
 &= - \int_B \left( \left( \kappa'(0) \cos \alpha(0) + \kappa(0) \tau(0) \sin \alpha(0) \right) y_2 \int_0^\infty \mathcal{V}_0^1 \right) \\
 &- \int_B \left( \left( -\kappa'(0) \sin \alpha(0) + \kappa(0) \tau(0) \cos \alpha(0) \right) y_3 \int_0^\infty \mathcal{V}_0^1 \right), \\
 &\int_{\mathcal{G}_0} \left( \kappa^2(0) \cos^2 \alpha(0) y_2 \mathcal{V}_0^2 - \kappa^2(0) \sin \alpha \cos \alpha(0) (y_3 \mathcal{V}_0^2 + y_2 \mathcal{V}_0^3) + \kappa^2(0) \sin^2 \alpha(0) y_3 \mathcal{V}_0^3 \right) \\
 &= \int_B \left( \frac{\kappa^2(0) \cos^2 \alpha(0)}{2} y_2^2 - \kappa^2(0) \sin \alpha(0) \cos \alpha(0) y_2 y_3 \right) \left( V_0^1(0, \cdot, t) - h_0^t \right) \\
 &= \int_B \frac{\kappa^2(0) \sin^2 \alpha(0)}{2} y_3^2 \left( V_0^1(0, \cdot, t) - h_0^t \right).
 \end{aligned}$$

Using the fact that  $\mathcal{V}_0^1, \mathcal{V}_1^1$  exponentially decay to zero as  $y_1 \rightarrow \infty$ , we get:

$$\begin{aligned}
 &- \int_{\mathcal{G}_0} 2\kappa(0) \left( \cos \alpha(0) y_2 - \sin \alpha(0) y_3 \right) \frac{\partial \mathcal{V}_1^1}{\partial y_1} \\
 &- \int_{\mathcal{G}_0} 3\kappa^2(0) \left( \cos^2 \alpha(0) y_2^2 - 2 \sin \alpha(0) \cos \alpha(0) y_2 y_3 + \sin^2(0) y_3^2 \right) \frac{\partial \mathcal{V}_0^1}{\partial y_1} \\
 &= \int_B \left( -2\kappa(0) \cos \alpha(0) y_2 + 2\kappa(0) \sin \alpha(0) y_3 \right) \left( V_1^1(0, \cdot, t) + \kappa(0) (e_\alpha(0) \cdot y') h_0^t \right) \\
 &+ \int_B \left( -3\kappa^2(0) \cos^2 \alpha(0) y_2^2 + 6\kappa^2 \sin \alpha(0) \cos \alpha(0) y_2 y_3 \right) \left( V_0^1(0, \cdot, t) - h_0^t \right) \\
 &\quad - \int_B 3\kappa^2(0) \sin^2(0) y_3^2 \left( V_0^1(0, \cdot, t) - h_0^t \right).
 \end{aligned}$$

On the other hand, we have

$$\begin{aligned}
 &- \int_B \mathcal{V}_2^1(0, \cdot, t) = \int_B V_2^1(0, \cdot, t) \\
 &= \int_B (|y'|^2 - 1) \left( B^1(0, t) y_2^2 + B^2(0, t) y_2 y_3 + B^3(0, t) y_3^2 + \tilde{B}^4(0, t) + \frac{1}{4\mu} p^1(t) \right).
 \end{aligned}$$

To ensure that the compatibility condition (4.53), we choose

$$p^1(t) = \frac{8\mu}{\pi} \left( - \int_{\mathcal{G}_0} \operatorname{div} \mathbf{V}_2 + \int_B (|y'|^2 - 1) \left( B^1(0, t) y_2^2 + B^2(0, t) y_2 y_3 + B^3(0, t) y_3^2 + \tilde{B}^4(0, t) \right) \right),$$

$$\text{where } \tilde{B}^4(x_1, t) = \frac{1}{4} \left( \frac{2}{\mu\pi} \frac{d}{dt} F_0^* - \frac{\kappa \cos \alpha}{8\mu} H^1 + \frac{\kappa \sin \alpha}{8\mu} H^2 + \frac{2\kappa^2}{\pi} F_0^* - \frac{a}{\mu} (H^{11} - H^{10}) \right) + \frac{1}{32} (A^1 + A^3).$$

The existence of the exponentially decaying unique solution corresponding to the problem on the opposite side for the second-order boundary layer correctors  $(\mathbf{V}_2, \mathcal{Q}_2)$  follows analogously, choosing the corresponding  $p^2(t)$  such that the compatibility condition holds.

**Remark 4.1** (Simplified model). *Let us consider a simplified model by assuming the following:  $\kappa, \alpha$  are constants,  $\mathbf{f}, \mathbf{g}$  vanish in the neighborhood of  $x_1 = 0$  and  $x_1 = l$ ,  $\int_0^l \mathbf{g} = 0$  and there hold the following relations:*

$$\int_B y_2^2 h_0^t = \int_B y_2^2 h_l^t, \quad \int_B y_2 y_3 h_0^t = \int_B y_2 y_3 h_l^t, \quad \int_B y_3^2 h_0^t = \int_B y_3^2 h_l^t.$$

We also take  $P_2(x_1, t) = x_1 p^{\text{bl}}(t) + p^{\text{div}}(x_1, t)$ , where  $p^{\text{bl}}(t)$  will be obtained from the compatibility conditions for the second-order boundary layer correctors and  $p^{\text{div}}$  will be chosen such that the  $\epsilon^4$  term in the divergence equation vanishes, thus improving our final estimate (see Section 4.3.3 and Section 4.4).

The following compatibility conditions needs to be fulfilled:

$$\begin{aligned} \int_{\mathcal{G}_0} \operatorname{div} \mathbf{V}_2 &= - \int_B \mathcal{V}_2^1(0, \cdot, t), \\ \int_{\mathcal{G}_l} \operatorname{div} \mathbf{V}_2 &= \int_B \mathcal{V}_2^1(0, \cdot, t). \end{aligned} \tag{4.54}$$

One can easily verify that the equations (4.54)<sub>1</sub> and (4.54)<sub>2</sub> are equivalent due to the assumptions of the simplified model, so choosing

$$p^{\text{bl}}(t) = \frac{8\mu}{\pi} \left( - \int_{\mathcal{G}_0} \operatorname{div} \mathbf{V}_2 + \int_B (|y'|^2 - 1) \left( B^1(0, t) y_2^2 + B^2(0, t) y_2 y_3 + B^3(0, t) y_3^2 + \tilde{B}^4(0, t) \right) \right),$$

where  $\tilde{B}^4(x_1, t) = \frac{1}{4} \left( \frac{2}{\mu\pi} \frac{d}{dt} F_0^* - \frac{\kappa \cos \alpha}{8\mu} H^1 + \frac{\kappa \sin \alpha}{8\mu} H^2 + \frac{2\kappa^2}{\pi} F_0^* - \frac{a}{\mu} (H^{11} - H^{10}) \right) + \frac{1}{32} (A^1 + A^3)$ , both the compatibility conditions (4.54) are satisfied.

We will address these considerations in Section 4.3.3 as they are essential in order to improve the divergence estimate.

## Boundary Layer for Microrotation

As for the velocity and pressure, we need to correct the microrotation approximation to satisfy the conditions on the ends of the pipe  $\Sigma_\epsilon^i$ ,  $i = 0, l$ .



Plugging the boundary layer correctors given by (4.45) into the angular momentum equation (4.12) and collecting the  $\epsilon^0$  terms, we obtain the problem for the microrotation zero-order boundary layer approximation at  $x_1 = 0$ :

$$\begin{aligned} -\delta\Delta\mathbf{W}_0 - \beta\nabla\operatorname{div}\mathbf{W}_0 &= \mathbf{0} \text{ in } \mathcal{G}_0, \\ \mathbf{W}_0 &= \mathbf{0} \text{ on } \omega = \langle 0, \infty \rangle \times \partial B, \\ (\mathcal{W}_0^1(0, \cdot, t), \mathcal{W}_0^2(0, \cdot, t), \mathcal{W}_0^3(0, \cdot, t)) &= -(W_0^1(0, \cdot, t), W_0^2(0, \cdot, t), W_0^3(0, \cdot, t)). \end{aligned}$$

The existence of a unique solution  $\mathbf{W}_0(\cdot, t) \in W^{1,2}(\mathcal{G}_0)$  exponentially decaying to zero as  $y_1 \rightarrow \infty$  can be easily proven (see [14]).

The first-order boundary layer microrotation corrector  $\mathbf{W}_1$  is the solution of the following system:

$$\begin{aligned} -\delta\Delta\mathbf{W}_1 - \beta\nabla\operatorname{div}\mathbf{W}_1 &= \Theta(0, t, \mathbf{v}_0, \mathbf{W}_0) \text{ in } \mathcal{G}_0, \\ \mathbf{W}_1 &= \mathbf{0} \text{ on } \omega = \langle 0, \infty \rangle \times \partial B, \\ (\mathcal{W}_1^1(0, \cdot, t), \mathcal{W}_1^2(0, \cdot, t), \mathcal{W}_1^3(0, \cdot, t)) &= -(W_1^1(0, \cdot, t), W_1^2(0, \cdot, t), W_1^3(0, \cdot, t)) \\ &\quad - (\kappa(0)(e_\alpha(0) \cdot y')W_0^1(0, \cdot, t), 0, 0) - (\kappa(0)(e_\alpha(0) \cdot y')W_0^1(0, \cdot, t), 0, 0), \end{aligned} \tag{4.55}$$

where  $\Theta(x_1, t, \mathbf{J}, \mathbf{K})$  is an exponentially decreasing function given in the Appendix (see (C.15)). The existence of the unique exponentially decreasing solution  $\mathbf{W}_1(\cdot, t) \in W^{1,2}(\mathcal{G}_0)$  is established in the same manner as for  $\mathbf{W}_0$ .

Finally, the system for the second-order boundary layer microrotation corrector  $\mathbf{W}_2$  is given by:

$$\begin{aligned} -\delta\Delta\mathbf{W}_2 - \beta\nabla\operatorname{div}\mathbf{W}_2 &= \Lambda(0, t, \mathbf{v}_0, \mathbf{v}_1, \mathbf{W}_0, \mathbf{W}_1) \text{ in } \mathcal{G}_0, \\ \mathbf{W}_2 &= \mathbf{0} \text{ on } \omega = \langle 0, \infty \rangle \times \partial B, \\ (\mathcal{W}_2^1(0, \cdot, t), \mathcal{W}_2^2(0, \cdot, t), \mathcal{W}_2^3(0, \cdot, t)) &= -(W_2^1(0, \cdot, t), W_2^2(0, \cdot, t), W_2^3(0, \cdot, t)) \\ &\quad - (\kappa(0)(e_\alpha(0) \cdot y')W_1^1(0, \cdot, t), 0, 0) - (\kappa^2(0)(e_\alpha(0) \cdot y')^2W_0^1(0, \cdot, t), 0, 0) \\ &\quad - (\kappa(0)(e_\alpha(0) \cdot y')W_1^1(0, \cdot, t), 0, 0) - (\kappa^2(0)(e_\alpha(0) \cdot y')^2W_0^1(0, \cdot, t), 0, 0), \end{aligned} \tag{4.56}$$

where  $\Theta(x_1, t, \mathbf{J}_0, \mathbf{J}_1, \mathbf{K}_0, \mathbf{K}_1)$  is an exponentially decreasing function given in the Appendix (see (C.16)). The existence of a unique exponentially decreasing solution  $\mathbf{W}_2(\cdot, t) \in W^{1,2}(\mathcal{G}_0)$  is established as for  $\mathbf{W}_0$  and  $\mathbf{W}_1$ .

The construction of the boundary layer correctors  $\mathbf{Z}_j$ ,  $j = 0, 1, 2$  on the opposite side  $x_1 = l$  can be done in the same way and the exponential decay easily follows.

### 4.3.3 Divergence Correction

Collecting the regular part of the approximation given by (4.44) and the boundary layer correctors at  $x_1 = 0$  and  $x_1 = l$  given by (4.45)–(4.46), we define our approximation as:

$$\begin{aligned}
\mathbf{U}_{\epsilon,[2]}(x, t) &= \mathbf{U}_{\epsilon,[2]}^{reg}(x, t) + \mathbf{U}_{\epsilon,[2]}^{bl,0}(x, t) + \mathbf{U}_{\epsilon,[2]}^{bl,l}(x, t) \\
&= \epsilon^2 \left( \mathbf{V}_0 \left( \frac{x'}{\epsilon}, t \right) + \mathbf{V}_0 \left( \frac{x_1}{\epsilon}, \frac{x'}{\epsilon}, t \right) + \mathbf{V}_0 \left( \frac{x_1 - l}{\epsilon}, \frac{x'}{\epsilon}, t \right) \right) \\
&\quad + \epsilon^3 \left( \mathbf{V}_1 \left( x_1, \frac{x'}{\epsilon}, t \right) + \mathbf{V}_1 \left( \frac{x_1}{\epsilon}, \frac{x'}{\epsilon}, t \right) + \mathbf{V}_1 \left( \frac{x_1 - l}{\epsilon}, \frac{x'}{\epsilon}, t \right) \right) \\
&\quad + \epsilon^4 \left( \mathbf{V}_2 \left( x_1, \frac{x'}{\epsilon}, t \right) + \mathbf{V}_2 \left( \frac{x_1}{\epsilon}, \frac{x'}{\epsilon}, t \right) + \mathbf{V}_2 \left( \frac{x_1 - l}{\epsilon}, \frac{x'}{\epsilon}, t \right) \right),
\end{aligned} \tag{4.57}$$

$$\begin{aligned}
\mathbf{W}_{\epsilon,[2]}(x, t) &= \mathbf{W}_{\epsilon,[2]}^{reg}(x, t) + \mathbf{W}_{\epsilon,[2]}^{bl,0}(x, t) + \mathbf{W}_{\epsilon,[2]}^{bl,l}(x, t) \\
&= \epsilon^2 \left( \mathbf{W}_0 \left( x_1, \frac{x'}{\epsilon}, t \right) + \mathbf{W}_0 \left( \frac{x_1}{\epsilon}, \frac{x'}{\epsilon}, t \right) + \mathbf{W}_0 \left( \frac{x_1 - l}{\epsilon}, \frac{x'}{\epsilon}, t \right) \right) \\
&\quad + \epsilon^3 \left( \mathbf{W}_1 \left( x_1, \frac{x'}{\epsilon}, t \right) + \mathbf{W}_1 \left( \frac{x_1}{\epsilon}, \frac{x'}{\epsilon}, t \right) + \mathbf{W}_1 \left( \frac{x_1 - l}{\epsilon}, \frac{x'}{\epsilon}, t \right) \right) \\
&\quad + \epsilon^4 \left( \mathbf{W}_2 \left( x_1, \frac{x'}{\epsilon}, t \right) + \mathbf{W}_2 \left( \frac{x_1}{\epsilon}, \frac{x'}{\epsilon}, t \right) + \mathbf{W}_2 \left( \frac{x_1 - l}{\epsilon}, \frac{x'}{\epsilon}, t \right) \right),
\end{aligned} \tag{4.58}$$

$$\begin{aligned}
P_{\epsilon,[2]}(x, t) &= P_{\epsilon,[3]}^{reg}(x, t) + P_{\epsilon,[2]}^{bl,0}(x, t) + P_{\epsilon,[2]}^{bl,l}(x, t) \\
&= P_0(x_1, t) + \epsilon \left( P_1 \left( x_1, \frac{x'}{\epsilon}, t \right) + \mathcal{P}_0 \left( \frac{x_1}{\epsilon}, \frac{x'}{\epsilon}, t \right) + \mathcal{Q}_0 \left( \frac{x_1 - l}{\epsilon}, \frac{x'}{\epsilon}, t \right) \right) \\
&\quad + \epsilon^2 \left( P_2 \left( x_1, \frac{x'}{\epsilon}, t \right) + \mathcal{P}_1 \left( \frac{x_1}{\epsilon}, \frac{x'}{\epsilon}, t \right) + \mathcal{Q}_1 \left( \frac{x_1 - l}{\epsilon}, \frac{x'}{\epsilon}, t \right) \right) \\
&\quad + \epsilon^3 \left( P_3 \left( x_1, \frac{x'}{\epsilon}, t \right) + \mathcal{P}_2 \left( \frac{x_1}{\epsilon}, \frac{x'}{\epsilon}, t \right) + \mathcal{Q}_2 \left( \frac{x_1 - l}{\epsilon}, \frac{x'}{\epsilon}, t \right) \right),
\end{aligned} \tag{4.59}$$

$$\mathbf{u}_{\epsilon,[2]}(\tilde{x}, t) = \mathbf{U}_{\epsilon,[2]}(x, t), \quad \mathbf{w}_{\epsilon,[2]}(\tilde{x}, t) = \mathbf{W}_{\epsilon,[2]}(x, t), \quad p_{\epsilon,[2]}(\tilde{x}, t) = P_{\epsilon,[2]}(x, t), \quad \tilde{x} = \Phi_\epsilon^\alpha(x), \tag{4.60}$$

where, for  $j = 0, 1, 2$ :

$$\begin{aligned}
\mathbf{V}_j &= V_j^1 \mathbf{a}^1 + V_j^2 \mathbf{a}^2 + V_j^3 \mathbf{a}^3, \quad \mathbf{V}_j = \mathcal{V}_j^1 \mathbf{a}^1 + \mathcal{V}_j^2 \mathbf{a}^2 + \mathcal{V}_j^3 \mathbf{a}^3, \\
\mathbf{Y}_j &= \mathcal{Y}_j^1 \mathbf{a}^1 + \mathcal{Y}_j^2 \mathbf{a}^2 + \mathcal{Y}_j^3 \mathbf{a}^3, \\
\mathbf{W}_j &= W_j^1 \mathbf{a}^1 + W_j^2 \mathbf{a}^2 + W_j^3 \mathbf{a}^3, \quad \mathbf{W}_j = \mathcal{W}_j^1 \mathbf{a}^1 + \mathcal{W}_j^2 \mathbf{a}^2 + \mathcal{W}_j^3 \mathbf{a}^3, \\
\mathbf{Z}_j &= \mathcal{Z}_j^1 \mathbf{a}^1 + \mathcal{Z}_j^2 \mathbf{a}^2 + \mathcal{Z}_j^3 \mathbf{a}^3.
\end{aligned} \tag{4.61}$$

It is well-known that the incompressibility equation needs one more corrector than the momentum and angular momentum equation (see e.g. [24]). Therefore, we need to correct

the residual in the divergence equation. Plugging the expansion (4.57) into the divergence equation (4.11), we obtain:

$$\begin{aligned}
 \operatorname{div} \mathbf{U}_{\epsilon,[2]} = & \epsilon \left( \frac{\partial V_0^2}{\partial y_2} + \frac{\partial V_0^3}{\partial y_3} \right) + \epsilon \left( \frac{\partial \mathcal{V}_0^1}{\partial y_1} + \frac{\partial \mathcal{V}_0^2}{\partial y_2} + \frac{\partial \mathcal{V}_0^3}{\partial y_3} \right) \\
 & + \epsilon \left( \frac{\partial \mathcal{Y}_0^1}{\partial y_1} + \frac{\partial \mathcal{Y}_0^2}{\partial y_2} + \frac{\partial \mathcal{Y}_0^3}{\partial y_3} \right) + \epsilon^2 \left( \frac{\partial V_0^1}{\partial x_1} + \frac{\partial V_1^2}{\partial y_2} + \frac{\partial V_1^3}{\partial y_3} \right) \\
 & + \epsilon^2 \left( \frac{\partial \mathcal{V}_1^1}{\partial y_1} + \frac{\partial \mathcal{V}_1^2}{\partial y_2} + \frac{\partial \mathcal{V}_1^3}{\partial y_3} - \kappa (\mathcal{V}_0^2 \cos \alpha - \mathcal{V}_0^3 \sin \alpha) \right) \\
 & + \epsilon^2 \left( 2\kappa \left( y_2 \cos \alpha \frac{\partial \mathcal{V}_0^1}{\partial y_1} - y_3 \sin \alpha \frac{\partial \mathcal{V}_0^1}{\partial y_1} \right) \right) \\
 & + \epsilon^2 \left( \frac{\partial \mathcal{Y}_1^1}{\partial y_1} + \frac{\partial \mathcal{Y}_1^2}{\partial y_2} + \frac{\partial \mathcal{Y}_1^3}{\partial y_3} - \kappa (\mathcal{Y}_0^2 \cos \alpha - \mathcal{Y}_0^3 \sin \alpha) \right) \\
 & + \epsilon^2 \left( 2\kappa \left( y_2 \cos \alpha \frac{\partial \mathcal{Y}_0^1}{\partial y_1} - y_3 \sin \alpha \frac{\partial \mathcal{Y}_0^1}{\partial y_1} \right) \right) \\
 & + \epsilon^3 \left( \frac{\partial V_1^1}{\partial x_1} - \kappa (V_1^2 \cos \alpha - V_1^3 \sin \alpha) + (\kappa' (e_\alpha \cdot y') + \kappa \tau (e_\alpha^\perp \cdot y')) V_0^1 \right) \\
 & + \epsilon^3 \left( \frac{\partial V_2^2}{\partial y_2} + \frac{\partial V_2^3}{\partial y_3} + \frac{\partial \mathcal{V}_2^1}{\partial y_1} + \frac{\partial \mathcal{V}_2^2}{\partial y_2} + \frac{\partial \mathcal{V}_2^3}{\partial y_3} \right) \\
 & + \epsilon^3 \left( -\kappa (\mathcal{V}_1^2 \cos \alpha - \mathcal{V}_1^3 \sin \alpha) + (\kappa' (e_\alpha \cdot y') + \kappa \tau (e_\alpha^\perp \cdot y')) \mathcal{V}_0^1 \right. \\
 & \quad \left. + \kappa^2 (e_\alpha \cdot y') \cos \alpha \mathcal{V}_0^2 - \kappa^2 (e_\alpha \cdot y') \sin \alpha \mathcal{V}_0^3 \right. \\
 & \quad \left. + 2\kappa (e_\alpha \cdot y') \left( \frac{\partial \mathcal{V}_1^1}{\partial y_1} - \kappa (\mathcal{V}_0^2 \cos \alpha - \mathcal{V}_0^3 \sin \alpha) \right) + 3\kappa^2 (e_\alpha \cdot y')^2 \frac{\partial \mathcal{V}_0^1}{\partial y_1} \right) \\
 & + \epsilon^3 \left( \frac{\partial \mathcal{Y}_2^1}{\partial y_1} + \frac{\partial \mathcal{Y}_2^2}{\partial y_2} + \frac{\partial \mathcal{Y}_2^3}{\partial y_3} - \kappa (\mathcal{Y}_1^2 \cos \alpha - \mathcal{Y}_1^3 \sin \alpha) \right. \\
 & \quad \left. + (\kappa' (e_\alpha \cdot y') + \kappa \tau (e_\alpha^\perp \cdot y')) \mathcal{Y}_0^1 + \kappa^2 (e_\alpha \cdot y') \cos \alpha \mathcal{Y}_0^2 - \kappa^2 (e_\alpha \cdot y') \sin \alpha \mathcal{Y}_0^3 \right. \\
 & \quad \left. + 2\kappa (e_\alpha \cdot y') \left( \frac{\partial \mathcal{Y}_1^1}{\partial y_1} - \kappa (\mathcal{Y}_0^2 \cos \alpha - \mathcal{Y}_0^3 \sin \alpha) \right) + 3\kappa^2 (e_\alpha \cdot y')^2 \frac{\partial \mathcal{Y}_0^1}{\partial y_1} \right) \\
 & + \epsilon^4 \left( \frac{\partial V_2^1}{\partial x_1} - \kappa (V_2^2 \cos \alpha - V_2^3 \sin \alpha) + (\kappa' (e_\alpha \cdot y') + \kappa \tau (e_\alpha^\perp \cdot y')) V_1^1 \right. \\
 & \quad \left. + \kappa (e_\alpha \cdot y') (\kappa' (e_\alpha \cdot y') + \kappa \tau (e_\alpha^\perp \cdot y')) V_0^1 + \kappa^2 (e_\alpha \cdot y') (\cos \alpha V_1^2 - \sin \alpha V_1^3) \right. \\
 & \quad \left. + 2\kappa (e_\alpha \cdot y') \left( \frac{\partial V_1^1}{\partial x_1} - \kappa (V_1^2 \cos \alpha - V_1^3 \sin \alpha) \right) \right. \\
 & \quad \left. + 2\kappa (e_\alpha \cdot y') (\kappa' (e_\alpha \cdot y') + \kappa \tau (e_\alpha^\perp \cdot y')) V_0^1 \right) \\
 & + \epsilon^4 \left( -\kappa (\mathcal{V}_2^2 \cos \alpha - \mathcal{V}_2^3 \sin \alpha) + (\kappa' (e_\alpha \cdot y') + \kappa \tau (e_\alpha^\perp \cdot y')) \mathcal{V}_1^1 \right. \\
 & \quad \left. + \kappa^2 (e_\alpha \cdot y') \cos \alpha \mathcal{V}_1^2 + \kappa (e_\alpha \cdot y') (\kappa (e_\alpha \cdot y') + \kappa \tau (e_\alpha^\perp \cdot y')) \mathcal{V}_0^1 \right. \\
 & \quad \left. - \kappa^2 (e_\alpha \cdot y') \sin \alpha \mathcal{V}_1^3 + 2\kappa (e_\alpha \cdot y') \left( \frac{\partial \mathcal{V}_2^1}{\partial y_1} - \kappa (\mathcal{V}_1^2 \cos \alpha - \mathcal{V}_1^3 \sin \alpha) \right) \right. \\
 & \quad \left. + 2\kappa (e_\alpha \cdot y') (\kappa' (e_\alpha \cdot y') + \kappa \tau (e_\alpha^\perp \cdot y')) \mathcal{V}_0^1 \right)
 \end{aligned}$$

$$\begin{aligned}
& + 2\kappa(e_\alpha \cdot y') \left( \kappa^2(e_\alpha \cdot y') \cos \alpha \mathcal{V}_0^2 - \kappa^2(e_\alpha \cdot y') \sin \alpha \mathcal{V}_0^3 \right) \\
& + 3\kappa^2(e_\alpha \cdot y')^2 \left( \frac{\partial \mathcal{V}_1^1}{\partial y_1} - \kappa(\mathcal{V}_0^2 \cos \alpha - \mathcal{V}_0^3 \sin \alpha) \right) + 4\kappa^3(e_\alpha \cdot y')^3 \frac{\partial \mathcal{V}_0^1}{\partial y_1} \\
& + \epsilon^4 \left( -\kappa(\mathcal{V}_2^2 \cos \alpha - \mathcal{V}_2^3 \sin \alpha) + (\kappa'(e_\alpha \cdot y') + \kappa\tau(e_\alpha^\perp \cdot y')) \mathcal{Y}_1^1 \right. \\
& \quad + \kappa(e_\alpha \cdot y') (\kappa(e_\alpha \cdot y') + \kappa\tau(e_\alpha^\perp \cdot y')) \mathcal{Y}_0^1 + \kappa^2(e_\alpha \cdot y') \cos \alpha \mathcal{Y}_1^2 \\
& \quad - \kappa^2(e_\alpha \cdot y') \sin \alpha \mathcal{Y}_1^3 + 2\kappa(e_\alpha \cdot y') \left( \frac{\partial \mathcal{Y}_2^1}{\partial y_1} - \kappa(\mathcal{Y}_1^2 \cos \alpha - \mathcal{Y}_1^3 \sin \alpha) \right) \\
& \quad + 2\kappa(e_\alpha \cdot y') \left( (\kappa'(e_\alpha \cdot y') + \kappa\tau(e_\alpha^\perp \cdot y')) \mathcal{Y}_0^1 + \kappa^2(e_\alpha \cdot y') \cos \alpha \mathcal{Y}_0^2 \right) \\
& \quad \left. - 2\kappa^3(e_\alpha \cdot y')^2 \sin \alpha \mathcal{Y}_0^3 + 3\kappa^2(e_\alpha \cdot y')^2 \left( \frac{\partial \mathcal{Y}_1^1}{\partial y_1} - \kappa(\mathcal{Y}_0^2 \cos \alpha - \mathcal{Y}_0^3 \sin \alpha) \right) \right. \\
& \quad \left. + 4\kappa^3(e_\alpha \cdot y')^3 \frac{\partial \mathcal{Y}_0^1}{\partial y_1} \right) \\
& + \mathcal{O}(\epsilon^5). \tag{4.62}
\end{aligned}$$

Taking into account (4.14)<sub>2</sub>, (4.25)<sub>2</sub>, (4.34)<sub>3</sub>, (4.47)<sub>2</sub>, (4.48)<sub>2</sub>, (4.49)<sub>2</sub>, (4.52)<sub>2</sub>, we get from (4.62) the following equation:

$$\begin{aligned}
\operatorname{div} \mathbf{U}_{\epsilon, [2]} & = \epsilon^2 \left( \kappa(0)(\mathcal{V}_0^2 \cos \alpha(0) - \mathcal{V}_0^3 \sin \alpha(0)) - \kappa(x_1)(\mathcal{V}_0^2 \cos \alpha(x_1) - \mathcal{V}_0^3 \sin \alpha(x_1)) \right) \\
& + \epsilon^2 \left( -2\kappa(0) \left( y_2 \cos \alpha(0) - y_3 \sin \alpha(0) \right) \frac{\partial \mathcal{V}_0^1}{\partial y_1} \right) \\
& + \epsilon^2 \left( 2\kappa(x_1) \left( y_2 \cos \alpha(x_1) - y_3 \sin \alpha(x_1) \right) \frac{\partial \mathcal{V}_0^1}{\partial y_1} \right) \\
& + \epsilon^2 \left( \kappa(l)(\mathcal{V}_0^2 \cos \alpha(l) - \mathcal{V}_0^3 \sin \alpha(l)) - \kappa(x_1)(\mathcal{V}_0^2 \cos \alpha(x_1) - \mathcal{V}_0^3 \sin \alpha(x_1)) \right) \\
& + \epsilon^2 \left( -2\kappa(l) \left( y_2 \cos \alpha(l) - y_3 \sin \alpha(l) \right) \frac{\partial \mathcal{V}_0^1}{\partial y_1} \right) \\
& + \epsilon^2 \left( 2\kappa(x_1) \left( y_2 \cos \alpha(x_1) - y_3 \sin \alpha(x_1) \right) \frac{\partial \mathcal{V}_0^1}{\partial y_1} \right) \\
& + \epsilon^3 \left( \kappa(0)(\mathcal{V}_1^2 \cos \alpha(0) - \mathcal{V}_1^3 \sin \alpha(0)) - \kappa(x_1)(\mathcal{V}_1^2 \cos \alpha(x_1) - \mathcal{V}_1^3 \sin \alpha(x_1)) \right) \\
& + \epsilon^3 \left( (-\kappa'(0)(y_2 \cos \alpha(0) - y_3 \sin \alpha(0)) - \kappa(0)\tau(0)(\sin \alpha(0)y_2 + \cos \alpha(0)y_3)) \mathcal{V}_0^1 \right) \\
& + \epsilon^3 \left( \kappa'(x_1)(y_2 \cos \alpha(x_1) - y_3 \sin \alpha(x_1)) \mathcal{V}_0^1 \right) \\
& + \epsilon^3 \left( \kappa(x_1)\tau(x_1)(\sin \alpha(x_1)y_2 + \cos \alpha(x_1)y_3) \mathcal{V}_0^1 \right) \\
& + \epsilon^3 \left( -\kappa^2(0)(y_2 \cos \alpha(0) - y_3 \sin \alpha(0))(\cos \alpha(0)\mathcal{V}_0^2 - \sin \alpha(0)\mathcal{V}_0^3) \right) \\
& + \epsilon^3 \left( \kappa^2(x_1)(y_2 \cos \alpha(x_1) - y_3 \sin \alpha(x_1)) \cos \alpha(x_1)\mathcal{V}_0^2 \right) \\
& + \epsilon^3 \left( -\kappa^2(x_1)(y_2 \cos \alpha(x_1) - y_3 \sin \alpha(x_1)) \sin \alpha(x_1)\mathcal{V}_0^3 \right)
\end{aligned}$$

$$\begin{aligned}
 & + \epsilon^3 \left( -2\kappa(0) \left( y_2 \cos \alpha(0) - y_3 \sin \alpha(0) \right) \frac{\partial \mathcal{V}_1^1}{\partial y_1} \right) \\
 & + \epsilon^3 \left( 2\kappa(x_1) \left( y_2 \cos \alpha(x_1) - y_3 \sin \alpha(x_1) \right) \frac{\partial \mathcal{V}_1^1}{\partial y_1} \right) \\
 & + \epsilon^3 \left( -3\kappa^2(0) (\cos \alpha(0) - \sin \alpha(0))^2 \frac{\partial \mathcal{V}_0^1}{\partial y_1} + 3\kappa^2(x_1) (\cos \alpha(x_1) - \sin \alpha(x_1))^2 \frac{\partial \mathcal{V}_0^1}{\partial y_1} \right) \\
 & + \epsilon^4 \left( \frac{\partial V_2^1}{\partial x_1} - \kappa(V_2^2 \cos \alpha - V_2^3 \sin \alpha) + (\kappa'(e_\alpha \cdot y') + \kappa\tau(e_\alpha^\perp \cdot y')) V_1^1 \right. \\
 & \quad + \kappa(e_\alpha \cdot y') (\kappa'(e_\alpha \cdot y') + \kappa\tau(e_\alpha^\perp \cdot y')) V_0^1 + \kappa^2(e_\alpha \cdot y') (\cos \alpha V_1^2 - \sin \alpha V_1^3) \\
 & \quad + 2\kappa(e_\alpha \cdot y') \left( \frac{\partial V_1^1}{\partial x_1} - \kappa(V_1^2 \cos \alpha - V_1^3 \sin \alpha) \right) \\
 & \quad \left. + 2\kappa(e_\alpha \cdot y') \left( (\kappa'(e_\alpha \cdot y') + \kappa\tau(e_\alpha^\perp \cdot y')) V_0^1 \right) \right) \\
 & + \pi_{\epsilon, res}, \tag{4.63}
 \end{aligned}$$

where  $\|\pi_{\epsilon, res}\|_{L^2(0, T; L^2(\Omega_\epsilon^2))} = \mathcal{O}(\epsilon^{11/2})$ . We write the above equation as

$$\pi_\epsilon = \pi_{\epsilon, 1} + \pi_{\epsilon, 2} + \pi_{\epsilon, 3} + \pi_{\epsilon, res}, \tag{4.64}$$

where  $\pi_{\epsilon, 1}$  is  $\epsilon^2$  term (first six lines),  $\pi_{\epsilon, 2}$  the  $\epsilon^3$  term (seventh to sixteenth line) and  $\pi_{\epsilon, 3}$  the  $\epsilon^4$  term (last four lines) in equation (4.63).

We now obtain for  $\pi_{\epsilon, 1}$ :

$$\begin{aligned}
 \pi_{\epsilon, 1} & = \epsilon^2 \left( \kappa(0) (\cos \alpha(0) - \cos \alpha(x_1)) + (\kappa(0) - \kappa(x_1)) \cos \alpha(x_1) \right) \mathcal{Y}_0^2 \\
 & - \epsilon^2 \left( \kappa(0) (\sin \alpha(0) - \sin \alpha(x_1)) + (\kappa(0) - \kappa(x_1)) \sin \alpha(x_1) \right) \mathcal{Y}_0^3 \\
 & - \epsilon^2 \left( 2\kappa(0) (\cos \alpha(0) - \cos \alpha(x_1)) + (2\kappa(0) - 2\kappa(x_1)) \cos \alpha(x_1) \right) y_2 \frac{\partial \mathcal{Y}_0^1}{\partial y_1} \\
 & + \epsilon^2 \left( 2\kappa(0) (\sin \alpha(0) - \sin \alpha(x_1)) + 2(\kappa(0) - \kappa(x_1)) \sin \alpha(x_1) \right) y_3 \frac{\partial \mathcal{Y}_0^1}{\partial y_1} \\
 & + \epsilon^2 \left( \kappa(l) (\cos \alpha(l) - \cos \alpha(x_1)) + (\kappa(l) - \kappa(x_1)) \cos \alpha(x_1) \right) \mathcal{Y}_0^2 \\
 & - \epsilon^2 \left( \kappa(l) (\sin \alpha(l) - \sin \alpha(x_1)) + (\kappa(l) - \kappa(x_1)) \sin \alpha(x_1) \right) \mathcal{Y}_0^3 \\
 & - \epsilon^2 \left( 2\kappa(l) (\cos \alpha(l) - \cos \alpha(x_1)) + (2\kappa(l) - 2\kappa(x_1)) \cos \alpha(x_1) \right) y_2 \frac{\partial \mathcal{Y}_0^1}{\partial y_1} \\
 & + \epsilon^2 \left( 2\kappa(l) (\sin \alpha(l) - \sin \alpha(x_1)) + 2(\kappa(l) - \kappa(x_1)) \sin \alpha(x_1) \right) y_3 \frac{\partial \mathcal{Y}_0^1}{\partial y_1}.
 \end{aligned}$$

Using a simple change of variables and the fact that  $\mathcal{Y}_0$  is concentrated near  $y_1 = 0$  and  $\mathcal{Y}_0$  near  $x_1 = l$ , we deduce the estimate

$$\|\pi_{\epsilon, 1}\|_{L^2(0, T; L^2(\Omega_\epsilon^2))} = \mathcal{O}(\epsilon^{9/2}), \tag{4.65}$$

and it easily follows from (4.63)–(4.64) that  $\|\pi_\epsilon\|_{L^2(0,T;L^2(\Omega_\epsilon^c))} = \mathcal{O}(\epsilon^{9/2})$ . It is important to observe that, since  $\pi_{\epsilon,i}$ ,  $i = 1, 2, 3$  do not vanish when integrated over the cross-section  $B$ , we cannot define the divergence corrector in the general case. For that reason, we look at the simplified model (see Remark 4.1) and complete the construction of the divergence correction in the following.

If we assume that  $\kappa$  and  $\alpha$  are constants, it easily follows from (4.63) that  $\pi_{\epsilon,1}$ ,  $\pi_{\epsilon,2} = 0$  so we have

$$\pi_\epsilon = \pi_{\epsilon,3} + \pi_{\epsilon,res}. \quad (4.66)$$

As in the general case,  $\int_B \pi_{\epsilon,3} \neq 0$ , so we obtain  $\|\pi_\epsilon\|_{L^2(0,T;L^2(\Omega_\epsilon^c))} = \mathcal{O}(\epsilon^5)$ .

If we additionally assume that  $\mathbf{f}, \mathbf{g}$  vanish in the neighborhood of  $x_1 = 0$  and  $x_1 = l$  and  $\int_0^l \mathbf{g} = 0$ , the following relations hold

$$\int_B y_2^2 h_0^t = \int_B y_2^2 h_l^t, \quad \int_B y_2 y_3 h_0^t = \int_B y_2 y_3 h_l^t, \quad \int_B y_3^2 h_0^t = \int_B y_3^2 h_l^t, \quad (4.67)$$

and taking  $P_2(x_1, t) = x_1 p^{bl}(t) + p^{div}(x_1, t)$ , we can choose  $p^{div}$  such that the  $\int_B \pi_{\epsilon,3} = 0$  (note that we have obtained  $p^{bl}$  from the compatibility conditions for the second-order velocity and pressure boundary layer correctors).

The  $\epsilon^4$  divergence term that needs to be corrected reads:

$$\begin{aligned} \pi_{\epsilon,3} &= \frac{\partial V_2^1}{\partial x_1} - \kappa(V_2^2 \cos \alpha - V_2^3 \sin \alpha) + \kappa^2(e_\alpha \cdot y')( \cos \alpha V_1^2 - \sin \alpha V_1^3) \\ &+ 2\kappa(e_\alpha \cdot y') \left( \frac{\partial V_1^1}{\partial x_1} - \kappa(V_1^2 \cos \alpha - V_1^3 \sin \alpha) \right), \end{aligned} \quad (4.68)$$

while

$$\begin{aligned} p^{div}(x_1, t) &= -\frac{\mu}{\int_B dB} \int_0^{x_1} \left( \int_0^\zeta \int_B (|y'|^2 - 1) \left( \frac{\partial B^1}{\partial x_1} y_2^2 + \frac{\partial B^2}{\partial x_1} y_2 y_3 + \frac{\partial B^3}{\partial x_1} y_3^2 \right) d\xi \right) d\zeta \\ &- \frac{\mu}{\int_B dB} \int_0^{x_1} \left( \int_0^\zeta \int_B (|y'|^2 - 1) \left( \frac{1}{4} \frac{\partial \tilde{A}_4}{\partial x_1} + \frac{1}{32} \left( \frac{\partial A^1}{\partial x_1} + \frac{\partial A^3}{\partial x_1} \right) \right) d\xi \right) d\zeta \\ &+ \frac{\mu}{\int_B} \int_0^{x_1} \left( \int_0^\zeta \kappa \left( \cos \alpha \int_B V_2^2 - \sin \alpha \int_B V_2^3 \right) d\xi \right) d\zeta \\ &- \frac{\mu}{\int_B} \int_0^{x_1} \left( \int_0^\zeta \int_B \kappa^2(e_\alpha \cdot y')( \cos \alpha V_1^2 - \sin \alpha V_1^3) d\xi \right) d\zeta \\ &- \frac{\mu}{\int_B} \int_0^{x_1} \left( \int_0^\zeta \int_B 2\kappa(e_\alpha \cdot y') \left( \frac{1}{8\mu} (1 - |y'|^2) (y_2 \frac{\partial H^1}{\partial x_1} + y_3 \frac{\partial H^2}{\partial x_1}) \right) d\xi \right) d\zeta \\ &- \frac{\mu}{\int_B} \int_0^{x_1} \left( \int_0^\zeta \int_B 2\kappa(e_\alpha \cdot y') \left( -\kappa(V_1^2 \cos \alpha - V_1^3 \sin \alpha) \right) d\xi \right) d\zeta, \end{aligned} \quad (4.69)$$

with  $A_4 = \frac{2}{\mu\pi} \frac{d}{dt} F_0^* - \frac{\kappa \cos \alpha}{8\mu} H^1 + \frac{\kappa \sin \alpha}{8\mu} H^2 - \frac{a}{\mu} (H^{11} - H^{10})$ . Observe that  $\frac{\partial p^{div}(x_1, t)}{\partial x_1}$  vanishes at  $x_1 = 0$  and  $x_1 = l$  due to our assumptions, and does not appear in the compatibility conditions for the velocity and pressure second-order boundary layer correctors at  $x_1 = 0$  and  $x_1 = l$ .

Finally, we can now define our divergence corrector as

$$\Psi_\epsilon(x, t) = \epsilon^5 \sum_{i=2}^3 \Psi^i \left( x_1, \frac{x'}{\epsilon} \right) \mathbf{a}^i, \quad (4.70)$$

where  $\Psi_\epsilon$  is the solution of the problem

$$\begin{aligned} \operatorname{div}_{y'} \Psi_\epsilon &= \pi_{\epsilon,3}, \\ \Psi_\epsilon &= \mathbf{0} \text{ on } \langle 0, l \rangle \times \partial B. \end{aligned} \quad (4.71)$$

In this case, we define  $\tilde{\mathbf{u}}_{\epsilon,[2]}(\tilde{x}, t) = \tilde{\mathbf{U}}_{\epsilon,[2]}(x, t)$ ,  $\tilde{x} = \Phi_\epsilon^\alpha(x)$ , where  $\tilde{\mathbf{U}}_{\epsilon,[2]} = \mathbf{U}_{\epsilon,[2]} - \Psi_\epsilon$ .

In this way, the divergence estimate is improved, namely:

$$\operatorname{div} \tilde{\mathbf{u}}_{\epsilon,[2]} = \tilde{\pi}_\epsilon, \quad \|\tilde{\pi}_\epsilon\|_{L^2(0,T;L^2(\Omega_\epsilon^\alpha))} = \mathcal{O}(\epsilon^{11/2}). \quad (4.72)$$

## 4.4 Rigorous Justification of the Model

### 4.4.1 Apriori Estimates

To derive the apriori estimates, we first provide two technical results, namely the Poincaré's inequality and the estimates for the divergence equation.

The following result is a direct consequence of [24, Lemma 7].

**Lemma 4.2** (Poincaré's inequality).

Let  $T \in \langle 0, \infty \rangle$  and  $t \in [0, T]$ . There then exists a constant  $C > 0$ , independent of  $\epsilon$ , such that

$$\|\varphi_\epsilon(\cdot, t)\|_{L^2(\Omega_\epsilon^\alpha)^3} \leq C\epsilon \|\nabla \varphi_\epsilon(\cdot, t)\|_{L^2(\Omega_\epsilon^\alpha)^3}, \quad (4.73)$$

for any  $\varphi_\epsilon(\cdot, t) \in W^{1,2}(\Omega_\epsilon^\alpha)^3$  such that  $\varphi_\epsilon = \mathbf{0}$  on  $\Gamma_\epsilon^\alpha$ .

We will also need to consider the following result on the divergence equation, which can be straightforwardly deduced from [24, Lemma 9].

**Lemma 4.3** (Divergence equation).

Let  $T \in \langle 0, \infty \rangle$  and  $t \in [0, T]$ . Furthermore, let  $\frac{\partial^j K}{\partial t^j} \in L^2(0, T; L^2(\Omega_\epsilon^\alpha))$ ,  $\frac{\partial^j \mathbf{g}_0}{\partial t^j} \in L^2(0, T; H^{1/2}(\Sigma_\epsilon^0)^3)$ ,  $\frac{\partial^j \mathbf{g}_l}{\partial t^j} \in L^2(0, T; H^{1/2}(\Sigma_\epsilon^l)^3)$  for  $j = 0, 1, 2$ . There then exists  $\varphi_\epsilon \in$

$L^2(0, T; W^{1,2}(\Omega_\epsilon^\alpha)^3)$  such that  $\frac{\partial^j \varphi_\epsilon}{\partial t^j} \in L^2(0, T; W^{1,2}(\Omega_\epsilon^\alpha)^3)$ ,  $j = 1, 2$  satisfying

$$\begin{aligned} \operatorname{div} \varphi_\epsilon &= K \text{ in } \Omega_\epsilon^\alpha, \\ \varphi_\epsilon &= \mathbf{0} \text{ on } \Gamma_\epsilon^\alpha, \\ \varphi &= \mathbf{g}_0 \text{ on } \Sigma_\epsilon^0, \quad \varphi = \mathbf{g}_l \text{ on } \Sigma_\epsilon^l, \end{aligned}$$

where

$$\int_{\Omega_\epsilon^\alpha} K = - \int_{\Sigma_\epsilon^0} \mathbf{g}_0 \cdot \mathbf{t}(0) + \int_{\Sigma_\epsilon^l} \mathbf{g}_l \cdot \mathbf{t}(l).$$

Moreover, if

$$\mathbf{g}_i^t = (\mathbf{g}_i \cdot \mathbf{t})\mathbf{t}, \quad \mathbf{g}_i^{nb} = (\mathbf{I} - \mathbf{t} \otimes \mathbf{t})\mathbf{g}_i, \quad i = 0, l,$$

then  $\varphi_\epsilon$  satisfies the following estimate

$$\begin{aligned} \|\nabla \varphi_\epsilon\|_{L^2(0, T; L^2(\Omega_\epsilon^\alpha)^3)} &\leq C \frac{1}{\epsilon} \|K\|_{L^2(0, T; L^2(\Omega_\epsilon^\alpha))} \\ &\quad + C \left( \frac{1}{\sqrt{\epsilon}} \left( \|\mathbf{g}_0^t\|_{L^2(0, T; H^{1/2}(\Sigma_\epsilon^0)^3)} + \|\mathbf{g}_l^t\|_{L^2(0, T; H^{1/2}(\Sigma_\epsilon^l)^3)} \right) \right) \\ &\quad + C \left( \|\mathbf{g}_0^{nb}\|_{L^2(0, T; H^{1/2}(\Sigma_\epsilon^0)^3)} + \|\mathbf{g}_l^{nb}\|_{L^2(0, T; H^{1/2}(\Sigma_\epsilon^l)^3)} \right), \\ \left\| \nabla \frac{\partial \varphi_\epsilon}{\partial t} \right\|_{L^2(0, T; L^2(\Omega_\epsilon^\alpha)^3)} &\leq C \left( \frac{1}{\epsilon} \left\| \frac{\partial K}{\partial t} \right\|_{L^2(0, T; L^2(\Omega_\epsilon^\alpha))} \right) \\ &\quad + C \left( \frac{1}{\sqrt{\epsilon}} \left( \left\| \frac{\partial \mathbf{g}_0^t}{\partial t} \right\|_{L^2(0, T; H^{1/2}(\Sigma_\epsilon^0)^3)} + \left\| \frac{\partial \mathbf{g}_l^t}{\partial t} \right\|_{L^2(0, T; H^{1/2}(\Sigma_\epsilon^l)^3)} \right) \right) \\ &\quad + C \left( \left\| \frac{\partial \mathbf{g}_0^{nb}}{\partial t} \right\|_{L^2(0, T; H^{1/2}(\Sigma_\epsilon^0)^3)} + \left\| \frac{\partial \mathbf{g}_l^{nb}}{\partial t} \right\|_{L^2(0, T; H^{1/2}(\Sigma_\epsilon^l)^3)} \right), \\ \left\| \nabla \frac{\partial^2 \varphi_\epsilon}{\partial t^2} \right\|_{L^2(0, T; L^2(\Omega_\epsilon^\alpha)^3)} &\leq C \left( \frac{1}{\epsilon} \left\| \frac{\partial^2 K}{\partial t^2} \right\|_{L^2(0, T; L^2(\Omega_\epsilon^\alpha))} \right) \\ &\quad + \frac{1}{\sqrt{\epsilon}} \left( \left\| \frac{\partial^2 \mathbf{g}_0^t}{\partial t^2} \right\|_{L^2(0, T; H^{1/2}(\Sigma_\epsilon^0)^3)} + \left\| \frac{\partial^2 \mathbf{g}_l^t}{\partial t^2} \right\|_{L^2(0, T; H^{1/2}(\Sigma_\epsilon^l)^3)} \right) \\ &\quad + C \left( \left\| \frac{\partial^2 \mathbf{g}_0^{nb}}{\partial t^2} \right\|_{L^2(0, T; H^{1/2}(\Sigma_\epsilon^0)^3)} + \left\| \frac{\partial^2 \mathbf{g}_l^{nb}}{\partial t^2} \right\|_{L^2(0, T; H^{1/2}(\Sigma_\epsilon^l)^3)} \right), \quad (4.74) \end{aligned}$$

where the constant  $C > 0$  is independent of  $\epsilon$ .

**Remark 4.4.**

It can be easily shown that we need higher time regularity conditions for the given data to ensure that  $\frac{\partial^j K}{\partial t^j} \in L^2(0, T; L^2(\Omega_\epsilon^\alpha))$ ,  $\frac{\partial^j \mathbf{g}_0}{\partial t^j} \in L^2(0, T; H^{1/2}(\Sigma_\epsilon^0)^3)$ ,  $\frac{\partial^j \mathbf{g}_l}{\partial t^j} \in L^2(0, T; H^{1/2}(\Sigma_\epsilon^l)^3)$ ,  $j = 0, 1, 2$ , namely:

$$\frac{\partial^j \mathbf{F}}{\partial t^j}, \frac{\partial^j \mathbf{G}}{\partial t^j}, \frac{\partial \mathbf{h}_0^\epsilon}{\partial t^j}, \frac{\partial \mathbf{h}_l^\epsilon}{\partial t^j} \in L^2(0, T; L^2(\Omega_\epsilon^\alpha)^3), \quad j = 0, 1, 2, 3.$$

The next step is to derive the a priori estimates for the velocity, pressure and microrotation.



**Proposition 4.5** (Apriori estimates).

Let  $T \in \langle 0, \infty \rangle$  and let  $(\mathbf{u}_\epsilon, \mathbf{w}_\epsilon, p_\epsilon) = (\mathbf{v}_\epsilon + \mathbf{h}_\epsilon, \mathbf{w}_\epsilon, p_\epsilon)$  be the solution of the problem (4.1)–(4.7). Then there exists a constant  $C > 0$ , independent of  $\epsilon$ , such that

$$\begin{aligned}
 & \|\mathbf{v}_\epsilon\|_{L^\infty(0,T;L^2(\Omega_\epsilon^3))} + \|\nabla \mathbf{v}_\epsilon\|_{L^2(0,T;L^2(\Omega_\epsilon^3))} \leq C\epsilon^2, \\
 & \left\| \frac{\partial \mathbf{v}_\epsilon}{\partial t} \right\|_{L^\infty(0,T;L^2(\Omega_\epsilon^3))} + \left\| \nabla \frac{\partial \mathbf{v}_\epsilon}{\partial t} \right\|_{L^2(0,T;L^2(\Omega_\epsilon^3))} \leq C\epsilon^2, \\
 & \|\mathbf{w}_\epsilon\|_{L^\infty(0,T;L^2(\Omega_\epsilon^3))} + \|\nabla \mathbf{w}_\epsilon\|_{L^2(0,T;L^2(\Omega_\epsilon^3))} \leq C\epsilon^2, \\
 & \left\| \frac{\partial \mathbf{w}_\epsilon}{\partial t} \right\|_{L^\infty(0,T;L^2(\Omega_\epsilon^3))}^2 + \left\| \nabla \frac{\partial \mathbf{w}_\epsilon}{\partial t} \right\|_{L^2(0,T;L^2(\Omega_\epsilon^3))}^2 \leq C\epsilon^2, \\
 & \|p_\epsilon\|_{L^2(0,T;L^2(\Omega_\epsilon^3))} \leq C\epsilon.
 \end{aligned} \tag{4.75}$$

*Proof.* Using  $\mathbf{w}_\epsilon$  as a test function in the integral identity (4.8)<sub>2</sub> yields

$$\begin{aligned}
 & \frac{1}{2} \frac{d}{dt} \int_{\Omega_\epsilon^3} |\mathbf{w}_\epsilon|^2 + \alpha \int_{\Omega_\epsilon^3} |\nabla \mathbf{w}_\epsilon|^2 + \beta \int_{\Omega_\epsilon^3} (\operatorname{div} \mathbf{w}_\epsilon)^2 + 2a \int_{\Omega_\epsilon^3} |\mathbf{w}_\epsilon|^2 \\
 & = a \int_{\Omega_\epsilon^3} \operatorname{rot} \mathbf{v}_\epsilon \mathbf{w}_\epsilon + a \int_{\Omega_\epsilon^3} \operatorname{rot} \mathbf{h}_\epsilon \mathbf{w}_\epsilon + \int_{\Omega_\epsilon^3} \mathbf{G} \mathbf{w}_\epsilon,
 \end{aligned} \tag{4.76}$$

Using inequality (4.73), we estimate the terms on the right-hand side of (4.76) to obtain:

$$\begin{aligned}
 & \left| \int_{\Omega_\epsilon^3} \operatorname{rot} \mathbf{v}_\epsilon \mathbf{w}_\epsilon \right| \leq \|\operatorname{rot} \mathbf{v}_\epsilon\|_{L^2(\Omega_\epsilon^3)} \|\mathbf{w}_\epsilon\|_{L^2(\Omega_\epsilon^3)} \leq C\epsilon \|\nabla \mathbf{v}_\epsilon\|_{L^2(\Omega_\epsilon^3)} \|\nabla \mathbf{w}_\epsilon\|_{L^2(\Omega_\epsilon^3)}, \\
 & \left| \int_{\Omega_\epsilon^3} \operatorname{rot} \mathbf{h}_\epsilon \mathbf{w}_\epsilon \right| \leq \|\operatorname{rot} \mathbf{h}_\epsilon\|_{L^2(\Omega_\epsilon^3)} \|\mathbf{w}_\epsilon\|_{L^2(\Omega_\epsilon^3)} \leq C\epsilon \|\nabla \mathbf{h}_\epsilon\|_{L^2(\Omega_\epsilon^3)} \|\nabla \mathbf{w}_\epsilon\|_{L^2(\Omega_\epsilon^3)}, \\
 & \left| \int_{\Omega_\epsilon^3} \mathbf{G} \mathbf{w}_\epsilon \right| \leq \|\mathbf{G}\|_{L^2(\Omega_\epsilon^3)} \|\mathbf{w}_\epsilon\|_{L^2(\Omega_\epsilon^3)} \leq C\epsilon^2 \|\nabla \mathbf{w}_\epsilon\|_{L^2(\Omega_\epsilon^3)}.
 \end{aligned} \tag{4.77}$$

Using estimates (4.77), Young's inequality, integrating over  $t$  in equation (4.76) and applying estimate (4.74)<sub>1</sub> we have:

$$\sup_{t \in [0, T]} \|\mathbf{w}_\epsilon(\cdot, t)\|_{L^2(\Omega_\epsilon^3)}^2 + \int_0^T \|\nabla \mathbf{w}_\epsilon\|_{L^2(\Omega_\epsilon^3)}^2 \leq C\epsilon^2 \int_0^T \|\nabla \mathbf{v}_\epsilon\|_{L^2(\Omega_\epsilon^3)}^2 + C\epsilon^4. \tag{4.78}$$

Differentiating the integral identity (4.8)<sub>2</sub> and taking  $\frac{\partial \mathbf{w}_\epsilon}{\partial t}$  as a test function, we obtain:

$$\begin{aligned}
 & \frac{1}{2} \frac{d}{dt} \int_{\Omega_\epsilon^3} \left| \frac{\partial \mathbf{w}_\epsilon}{\partial t} \right|^2 + \alpha \int_{\Omega_\epsilon^3} \left| \nabla \frac{\partial \mathbf{w}_\epsilon}{\partial t} \right|^2 + \beta \int_{\Omega_\epsilon^3} \left( \operatorname{div} \frac{\partial \mathbf{w}_\epsilon}{\partial t} \right)^2 + 2a \int_{\Omega_\epsilon^3} \left| \frac{\partial \mathbf{w}_\epsilon}{\partial t} \right|^2 \\
 & = a \int_{\Omega_\epsilon^3} \operatorname{rot} \frac{\partial \mathbf{v}_\epsilon}{\partial t} \frac{\partial \mathbf{w}_\epsilon}{\partial t} + a \int_{\Omega_\epsilon^3} \operatorname{rot} \frac{\partial \mathbf{h}_\epsilon}{\partial t} \frac{\partial \mathbf{w}_\epsilon}{\partial t} + \int_{\Omega_\epsilon^3} \frac{\partial \mathbf{G}}{\partial t} \frac{\partial \mathbf{w}_\epsilon}{\partial t}.
 \end{aligned} \tag{4.79}$$

Again, estimating the terms on the right-hand side as above, using Young's inequality, integrating over  $t$  in (4.79) and using (4.74)<sub>2</sub>, we obtain :

$$\sup_{t \in [0, T]} \left\| \frac{\partial \mathbf{w}_\epsilon}{\partial t}(\cdot, t) \right\|_{L^2(\Omega_\epsilon^3)}^2 + \int_0^T \left\| \nabla \frac{\partial \mathbf{w}_\epsilon}{\partial t} \right\|_{L^2(\Omega_\epsilon^3)}^2 \leq C\epsilon^2 \int_0^T \left\| \nabla \frac{\partial \mathbf{v}_\epsilon}{\partial t} \right\|_{L^2(\Omega_\epsilon^3)}^2 + C\epsilon^4. \tag{4.80}$$

We now multiply the integral identity (4.8)<sub>1</sub> with  $\mathbf{v}_\epsilon$  and integrate over  $\Omega_\epsilon^\alpha$  to obtain

$$\frac{1}{2} \frac{d}{dt} \int_{\Omega_\epsilon^\alpha} |\mathbf{v}_\epsilon|^2 + \mu \int_{\Omega_\epsilon^\alpha} |\nabla \mathbf{v}_\epsilon|^2 = a \int_{\Omega_\epsilon^\alpha} \operatorname{rot} \mathbf{w}_\epsilon \mathbf{v}_\epsilon + \int_{\Omega_\epsilon^\alpha} \mathbf{F} \mathbf{v}_\epsilon - \int_{\Omega_\epsilon^\alpha} \frac{\partial \mathbf{h}_\epsilon}{\partial t} \mathbf{v}_\epsilon - \int_{\Omega_\epsilon^\alpha} \nabla \mathbf{h}_\epsilon \nabla \mathbf{v}_\epsilon. \quad (4.81)$$

We carefully estimate the terms on the right-hand side of (4.81) as follows:

$$\begin{aligned} \left| \int_{\Omega_\epsilon^\alpha} \operatorname{rot} \mathbf{w}_\epsilon \mathbf{v}_\epsilon \right| &\leq C\epsilon \|\nabla \mathbf{v}_\epsilon\|_{L^2(\Omega_\epsilon^\alpha)^3} \|\nabla \mathbf{w}_\epsilon\|_{L^2(\Omega_\epsilon^\alpha)^3}, \\ \left| \int_{\Omega_\epsilon^\alpha} \mathbf{F} \mathbf{v}_\epsilon \right| &\leq \|\mathbf{F}\|_{L^2(\Omega_\epsilon^\alpha)^3} \|\mathbf{v}_\epsilon\|_{L^2(\Omega_\epsilon^\alpha)^3} \leq C\epsilon^2 \|\nabla \mathbf{v}_\epsilon\|_{L^2(\Omega_\epsilon^\alpha)^3}, \\ \left| \int_{\Omega_\epsilon^\alpha} \frac{\partial \mathbf{h}_\epsilon}{\partial t} \mathbf{v}_\epsilon \right| &\leq \left\| \frac{\partial \mathbf{h}_\epsilon}{\partial t} \right\|_{L^2(\Omega_\epsilon^\alpha)^3} \|\mathbf{v}_\epsilon\|_{L^2(\Omega_\epsilon^\alpha)^3} \leq C\epsilon^2 \left\| \nabla \frac{\partial \mathbf{h}_\epsilon}{\partial t} \right\|_{L^2(\Omega_\epsilon^\alpha)^3} \|\nabla \mathbf{v}_\epsilon\|_{L^2(\Omega_\epsilon^\alpha)^3}, \\ \left| \int_{\Omega_\epsilon^\alpha} \nabla \mathbf{h}_\epsilon \nabla \mathbf{v}_\epsilon \right| &\leq \|\nabla \mathbf{h}_\epsilon\|_{L^2(\Omega_\epsilon^\alpha)^3} \|\nabla \mathbf{v}_\epsilon\|_{L^2(\Omega_\epsilon^\alpha)^3}. \end{aligned} \quad (4.82)$$

Applying (4.82) and Young's inequality on the right-hand side of (4.81), integrating over  $t$  and using estimates (4.74)<sub>1</sub>–(4.74)<sub>2</sub>, we have

$$\sup_{t \in [0, T]} \|\mathbf{v}_\epsilon(\cdot, t)\|_{L^2(\Omega_\epsilon^\alpha)^3}^2 + \int_0^T \|\nabla \mathbf{v}_\epsilon\|_{L^2(\Omega_\epsilon^\alpha)^3}^2 \leq C\epsilon^2 \int_0^T \|\nabla \mathbf{w}_\epsilon\|_{L^2(\Omega_\epsilon^\alpha)^3}^2 + C\epsilon^4. \quad (4.83)$$

Finally, combining the estimates (4.78) and (4.83), for sufficiently small  $\epsilon$ , we obtain:

$$\sup_{t \in [0, T]} \|\mathbf{v}_\epsilon(\cdot, t)\|_{L^2(\Omega_\epsilon^\alpha)^3}^2 + \int_0^T \|\nabla \mathbf{v}_\epsilon\|_{L^2(\Omega_\epsilon^\alpha)^3}^2 \leq C\epsilon^4, \quad (4.84)$$

and

$$\sup_{t \in [0, T]} \|\mathbf{w}_\epsilon(\cdot, t)\|_{L^2(\Omega_\epsilon^\alpha)^3}^2 + \int_0^T \|\nabla \mathbf{w}_\epsilon\|_{L^2(\Omega_\epsilon^\alpha)^3}^2 \leq C\epsilon^4, \quad (4.85)$$

proving (4.75)<sub>1</sub> and (4.74)<sub>3</sub>.

Differentiating the integral identity (4.8)<sub>1</sub> and using  $\frac{\partial \mathbf{v}_\epsilon}{\partial t}$  as a test function, we get

$$\begin{aligned} \frac{1}{2} \frac{d}{dt} \int_{\Omega_\epsilon^\alpha} \left| \frac{\partial \mathbf{v}_\epsilon}{\partial t} \right|^2 + \mu \int_0^t \left| \nabla \frac{\partial \mathbf{v}_\epsilon}{\partial t} \right|^2 &= a \int_{\Omega_\epsilon^\alpha} \operatorname{rot} \frac{\partial \mathbf{w}_\epsilon}{\partial t} \frac{\partial \mathbf{v}_\epsilon}{\partial t} + \int_{\Omega_\epsilon^\alpha} \frac{\partial \mathbf{F}}{\partial t} \frac{\partial \mathbf{v}_\epsilon}{\partial t} \\ &\quad - \int_{\Omega_\epsilon^\alpha} \frac{\partial^2 \mathbf{h}_\epsilon}{\partial t^2} \frac{\partial \mathbf{v}_\epsilon}{\partial t} - \int_{\Omega_\epsilon^\alpha} \nabla \frac{\partial \mathbf{h}_\epsilon}{\partial t} \nabla \frac{\partial \mathbf{v}_\epsilon}{\partial t}. \end{aligned} \quad (4.86)$$

In much the same way as for (4.81), estimating the terms on right-hand side using Young's inequality in equation (4.86), integrating over  $t$  and using (4.74)<sub>2</sub>–(4.74)<sub>3</sub>, we arrive at:

$$\left\| \frac{\partial \mathbf{v}_\epsilon}{\partial t} \right\|_{L^2(\Omega_\epsilon^\alpha)^3}^2 + \int_0^t \left\| \nabla \frac{\partial \mathbf{v}_\epsilon}{\partial t} \right\|_{L^2(\Omega_\epsilon^\alpha)^3}^2 \leq C\epsilon^2 \int_0^t \left\| \nabla \frac{\partial \mathbf{w}_\epsilon}{\partial t} \right\|_{L^2(\Omega_\epsilon^\alpha)^3}^2 + C\epsilon^4. \quad (4.87)$$

Combining the estimates (4.80) and (4.87), for sufficiently small  $\epsilon$  we have:

$$\sup_{t \in [0, T]} \left\| \frac{\partial \mathbf{v}_\epsilon}{\partial t}(\cdot, t) \right\|_{L^2(\Omega_\epsilon^\alpha)^3}^2 + \int_0^T \left\| \nabla \frac{\partial \mathbf{v}_\epsilon}{\partial t} \right\|_{L^2(\Omega_\epsilon^\alpha)^3}^2 \leq C\epsilon^4, \quad (4.88)$$

and

$$\sup_{t \in [0, T]} \left\| \frac{\partial \mathbf{w}_\epsilon}{\partial t}(\cdot, t) \right\|_{L^2(\Omega_\epsilon^\alpha)^3}^2 + \int_0^T \left\| \nabla \frac{\partial \mathbf{w}_\epsilon}{\partial t} \right\|_{L^2(\Omega_\epsilon^\alpha)^3}^2 \leq C\epsilon^4 \quad (4.89)$$

leading to (4.75)<sub>2</sub> and (4.75)<sub>4</sub>.

We now need to estimate the pressure. Let  $\mathbf{d}_\epsilon$  be the solution of the problem:

$$\begin{aligned} \operatorname{div} \mathbf{d}_\epsilon &= p_\epsilon, \\ \mathbf{d}_\epsilon &= \mathbf{0} \text{ on } \partial\Omega_\epsilon^\alpha. \end{aligned} \quad (4.90)$$

Supposing  $\int_{\Omega_\epsilon^\alpha} p_\epsilon = 0$ , for all  $t$ , it follows from Lemma 4.3 that (4.90) has at least one solution satisfying

$$\|\nabla \mathbf{d}_\epsilon\|_{L^2(0, T; L^2(\Omega_\epsilon^\alpha)^3)} \leq \frac{C}{\epsilon} \|p_\epsilon\|_{L^2(0, T; L^2(\Omega_\epsilon^\alpha)^3)}. \quad (4.91)$$

Multiplying the momentum equation (4.1)<sub>1</sub> with  $\mathbf{d}_\epsilon$  and integrating over  $\Omega_\epsilon^\alpha$  yields

$$\begin{aligned} \|p_\epsilon\|_{L^2(\Omega_\epsilon^\alpha)^3}^2 &\leq \int_{\Omega_\epsilon^\alpha} \frac{\partial \mathbf{v}_\epsilon}{\partial t} \mathbf{d}_\epsilon + \int_{\Omega_\epsilon^\alpha} \frac{\partial \mathbf{h}_\epsilon}{\partial t} \mathbf{d}_\epsilon + \mu \int_{\Omega_\epsilon^\alpha} \nabla \mathbf{v}_\epsilon \nabla \mathbf{d}_\epsilon \\ &\quad + \mu \int_{\Omega_\epsilon^\alpha} \nabla \mathbf{h}_\epsilon \nabla \mathbf{d}_\epsilon - a \int_{\Omega_\epsilon^\alpha} \operatorname{rot} \mathbf{w}_\epsilon \mathbf{d}_\epsilon - \int_{\Omega_\epsilon^\alpha} \mathbf{f}_\epsilon \mathbf{d}_\epsilon. \end{aligned} \quad (4.92)$$

We estimate the terms on the right-hand side of (4.92) using Poincaré's inequality (4.73) to obtain

$$\begin{aligned} \left| \int_{\Omega_\epsilon^\alpha} \frac{\partial \mathbf{v}_\epsilon}{\partial t} \mathbf{d}_\epsilon \right| &\leq \left\| \frac{\partial \mathbf{v}_\epsilon}{\partial t} \right\|_{L^2(\Omega_\epsilon^\alpha)^3} \|\mathbf{d}_\epsilon\|_{L^2(\Omega_\epsilon^\alpha)^3} \leq C\epsilon^2 \left\| \nabla \frac{\partial \mathbf{v}_\epsilon}{\partial t} \right\|_{L^2(\Omega_\epsilon^\alpha)^3} \|\nabla \mathbf{d}_\epsilon\|_{L^2(\Omega_\epsilon^\alpha)^3}, \\ \left| \int_{\Omega_\epsilon^\alpha} \frac{\partial \mathbf{h}_\epsilon}{\partial t} \mathbf{d}_\epsilon \right| &\leq \left\| \frac{\partial \mathbf{h}_\epsilon}{\partial t} \right\|_{L^2(\Omega_\epsilon^\alpha)^3} \|\mathbf{d}_\epsilon\|_{L^2(\Omega_\epsilon^\alpha)^3} \leq C\epsilon^2 \left\| \nabla \frac{\partial \mathbf{h}_\epsilon}{\partial t} \right\|_{L^2(\Omega_\epsilon^\alpha)^3} \|\nabla \mathbf{d}_\epsilon\|_{L^2(\Omega_\epsilon^\alpha)^3}, \\ \left| \int_{\Omega_\epsilon^\alpha} \nabla \mathbf{v}_\epsilon \nabla \mathbf{d}_\epsilon \right| &\leq \|\nabla \mathbf{v}_\epsilon\|_{L^2(\Omega_\epsilon^\alpha)^3} \|\nabla \mathbf{d}_\epsilon\|_{L^2(\Omega_\epsilon^\alpha)^3}, \\ \left| \int_{\Omega_\epsilon^\alpha} \nabla \mathbf{h}_\epsilon \nabla \mathbf{d}_\epsilon \right| &\leq \|\nabla \mathbf{h}_\epsilon\|_{L^2(\Omega_\epsilon^\alpha)^3} \|\nabla \mathbf{d}_\epsilon\|_{L^2(\Omega_\epsilon^\alpha)^3}, \\ \left| \int_{\Omega_\epsilon^\alpha} \operatorname{rot} \mathbf{w}_\epsilon \mathbf{d}_\epsilon \right| &\leq C\epsilon \|\nabla \mathbf{w}_\epsilon\|_{L^2(\Omega_\epsilon^\alpha)^3} \|\nabla \mathbf{d}_\epsilon\|_{L^2(\Omega_\epsilon^\alpha)^3}, \\ \left| \int_{\Omega_\epsilon^\alpha} \mathbf{f}_\epsilon \mathbf{d}_\epsilon \right| &\leq C \|\mathbf{f}_\epsilon\|_{L^2(\Omega_\epsilon^\alpha)^3} \|\mathbf{d}_\epsilon\|_{L^2(\Omega_\epsilon^\alpha)^3} \leq C\epsilon^2 \|\nabla \mathbf{d}_\epsilon\|_{L^2(\Omega_\epsilon^\alpha)^3}. \end{aligned} \quad (4.93)$$

Using the estimates (4.93) and Young's inequality on the right-hand side of equation (4.92), integrating over  $t$  and using (4.74)<sub>1</sub>–(4.74)<sub>2</sub>, (4.84)–(4.85), (4.88) and (4.91), we deduce

$$\|p_\epsilon\|_{L^2(0,T;L^2(\Omega_\epsilon^\alpha))} \leq C\epsilon \quad (4.94)$$

completing the proof.  $\square$

## 4.4.2 Error Estimates

In the following, we provide the main result of this Section.

**Theorem 4.6** (Error estimate).

Let  $T \in \langle 0, \infty \rangle$  and let  $(\mathbf{u}_{\epsilon,[2]}, \mathbf{w}_{\epsilon,[2]}, p_{\epsilon,[2]})$ , be the asymptotic solution defined by (4.57)–(4.61) and  $(\mathbf{u}_\epsilon, \mathbf{w}_\epsilon, p_\epsilon)$  the solution of the governing problem (4.1)–(4.7). Then the following estimates hold:

$$\begin{aligned} & \|\mathbf{u}_\epsilon - \mathbf{u}_{\epsilon,[2]}\|_{L^\infty(0,T;L^2(\Omega_\epsilon^\alpha)^3)} + \|\nabla(\mathbf{u}_\epsilon - \mathbf{u}_{\epsilon,[2]})\|_{L^2(0,T;L^2(\Omega_\epsilon^\alpha)^3)} \leq C\epsilon^{7/2}, \\ & \left\| \frac{\partial \mathbf{u}_\epsilon}{\partial t} - \frac{\partial \mathbf{u}_{\epsilon,[2]}}{\partial t} \right\|_{L^\infty(0,T;L^2(\Omega_\epsilon^\alpha)^3)} + \left\| \nabla \left( \frac{\partial \mathbf{u}_\epsilon}{\partial t} - \frac{\partial \mathbf{u}_{\epsilon,[2]}}{\partial t} \right) \right\|_{L^2(0,T;L^2(\Omega_\epsilon^\alpha)^3)} \leq C\epsilon^{7/2}, \\ & \|\mathbf{w}_\epsilon - \mathbf{w}_{\epsilon,[2]}\|_{L^\infty(0,T;L^2(\Omega_\epsilon^\alpha)^3)} + \|\nabla(\mathbf{w}_\epsilon - \mathbf{w}_{\epsilon,[2]})\|_{L^2(0,T;L^2(\Omega_\epsilon^\alpha)^3)} \leq C\epsilon^{9/2}, \\ & \left\| \frac{\partial \mathbf{w}_\epsilon}{\partial t} - \frac{\partial \mathbf{w}_{\epsilon,[2]}}{\partial t} \right\|_{L^\infty(0,T;L^2(\Omega_\epsilon^\alpha)^3)} + \left\| \nabla \left( \frac{\partial \mathbf{w}_\epsilon}{\partial t} - \frac{\partial \mathbf{w}_{\epsilon,[2]}}{\partial t} \right) \right\|_{L^2(0,T;L^2(\Omega_\epsilon^\alpha)^3)} \leq C\epsilon^{9/2}, \\ & \|p_\epsilon - p_{\epsilon,[2]}\|_{L^2(0,T;L^2(\Omega_\epsilon^\alpha))} \leq C\epsilon^{5/2}, \end{aligned} \quad (4.95)$$

where the constant  $C > 0$  is independent of  $\epsilon$ .

*Proof.* The asymptotic approximation  $\mathbf{w}_{\epsilon,[2]}$  for the microrotation satisfies the following equation:

$$\begin{aligned} & \frac{\partial \mathbf{w}_{\epsilon,[2]}}{\partial t} - \delta \Delta \mathbf{w}_{\epsilon,[2]} - \beta \nabla \operatorname{div} \mathbf{w}_{\epsilon,[2]} + 2a \mathbf{w}_{\epsilon,[2]} = a \operatorname{rot} \mathbf{u}_{\epsilon,[1]} + \mathbf{G} + \boldsymbol{\xi}_\epsilon \text{ in } \Omega_\epsilon^\alpha, \\ & \mathbf{w}_{\epsilon,[2]} = \mathbf{0} \text{ on } \Gamma_\epsilon^\alpha, \\ & \mathbf{w}_{\epsilon,[2]} = \boldsymbol{\eta}_0^\epsilon \text{ on } \Sigma_\epsilon^0, \quad \mathbf{w}_{\epsilon,[2]} = \boldsymbol{\eta}_l^\epsilon \text{ on } \Sigma_\epsilon^l, \\ & \mathbf{w}_{\epsilon,[2]}(\cdot, 0) = \mathbf{0}. \end{aligned} \quad (4.96)$$

where  $\|\boldsymbol{\xi}_\epsilon\|_{L^2(0,T;L^2(\Omega_\epsilon^\alpha)^3)} = \mathcal{O}(\epsilon^4)$  and  $\|\boldsymbol{\eta}_i^\epsilon\|_{L^2(0,T;H^{1/2}(\Sigma_i^3))} = \mathcal{O}(\epsilon^{11/2})$ ,  $i = 0, l$ .

Denoting

$$\mathbf{s}_\epsilon = \mathbf{w}_\epsilon - \mathbf{w}_{\epsilon,[2]},$$

and subtracting (4.1)<sub>3</sub>, (4.2)<sub>2</sub>, (4.2)<sub>3,2</sub> and (4.96), we obtain

$$\begin{aligned} \frac{\partial \mathbf{s}_\epsilon}{\partial t} - \alpha \Delta \mathbf{s}_\epsilon - \beta \nabla \operatorname{div} \mathbf{s}_\epsilon + 2a \mathbf{s}_\epsilon &= a \operatorname{rot}(\mathbf{u}_\epsilon - \mathbf{u}_{\epsilon,[1]}) - \boldsymbol{\xi}_\epsilon, \\ \mathbf{s}_\epsilon &= \mathbf{0} \text{ on } \Gamma_\epsilon^\alpha, \\ \mathbf{s}_\epsilon &= -\boldsymbol{\eta}_0^\epsilon \text{ on } \Sigma_\epsilon^0, \quad \mathbf{s}_\epsilon = -\boldsymbol{\eta}_l^\epsilon \text{ on } \Sigma_\epsilon^l, \\ \mathbf{s}_\epsilon(\cdot, 0) &= \mathbf{0}. \end{aligned} \quad (4.97)$$

It follows from Lemma 4.3 that we can construct a function  $\mathbf{D}_\epsilon$  with the same trace as  $\mathbf{s}_\epsilon$  on  $\partial\Omega_\epsilon^\alpha$  such that

$$\|\nabla \mathbf{D}_\epsilon\|_{L^2(0,T;L^2(\Omega_\epsilon^\alpha)^3)} + \left\| \nabla \frac{\partial \mathbf{D}_\epsilon}{\partial t} \right\|_{L^2(0,T;L^2(\Omega_\epsilon^\alpha)^3)} + \left\| \nabla \frac{\partial^2 \mathbf{D}_\epsilon}{\partial t^2} \right\|_{L^2(0,T;L^2(\Omega_\epsilon^\alpha)^3)} \leq C\epsilon^5. \quad (4.98)$$

Multiplying the equation (4.97)<sub>1</sub> by  $\mathbf{s}^* = \mathbf{s}_\epsilon - \mathbf{D}_\epsilon$  and integrating over  $\Omega_\epsilon^\alpha$  yields

$$\begin{aligned} \frac{1}{2} \frac{d}{dt} \int_{\Omega_\epsilon^\alpha} |\mathbf{s}_\epsilon^*|^2 + \alpha \int_{\Omega_\epsilon^\alpha} |\nabla \mathbf{s}_\epsilon^*|^2 + \beta \int_{\Omega_\epsilon^\alpha} (\operatorname{div} \mathbf{s}_\epsilon^*)^2 + 2a \int_{\Omega_\epsilon^\alpha} |\mathbf{s}_\epsilon^*|^2 \\ = a \int_{\Omega_\epsilon^\alpha} \operatorname{rot}(\mathbf{u}_\epsilon - \mathbf{u}_{\epsilon,[1]}) \mathbf{s}_\epsilon^* - \int_{\Omega_\epsilon^\alpha} \frac{\partial \mathbf{D}_\epsilon}{\partial t} \mathbf{s}_\epsilon^* - \delta \int_{\Omega_\epsilon^\alpha} \nabla \mathbf{s}_\epsilon^* \nabla \mathbf{D}_\epsilon \\ - \beta \int_{\Omega_\epsilon^\alpha} \operatorname{div} \mathbf{D}_\epsilon \operatorname{div} \mathbf{s}_\epsilon^* - 2a \int_{\Omega_\epsilon^\alpha} \mathbf{s}_\epsilon^* \mathbf{D}_\epsilon - \int_{\Omega_\epsilon^\alpha} \boldsymbol{\xi}_\epsilon \mathbf{s}_\epsilon^*. \end{aligned} \quad (4.99)$$

We now estimate the terms on the right-hand side of (4.99) using Poincaré's inequality (4.73) in the following way:

$$\begin{aligned} \left| \int_{\Omega_\epsilon^\alpha} \operatorname{rot}(\mathbf{u}_\epsilon - \mathbf{u}_{\epsilon,[1]}) \mathbf{s}_\epsilon^* \right| &\leq C \|\nabla(\mathbf{u}_\epsilon - \mathbf{u}_{\epsilon,[1]})\|_{L^2(\Omega_\epsilon^\alpha)^3} \|\mathbf{s}_\epsilon^*\|_{L^2(\Omega_\epsilon^\alpha)^3} \\ &\leq C \left( \|\nabla(\mathbf{u}_\epsilon - \mathbf{u}_{\epsilon,[2]})\|_{L^2(\Omega_\epsilon^\alpha)^3} + \|\nabla(\mathbf{u}_{\epsilon,[2]} - \mathbf{u}_{\epsilon,[1]})\|_{L^2(\Omega_\epsilon^\alpha)^3} \right) \|\mathbf{s}_\epsilon^*\|_{L^2(\Omega_\epsilon^\alpha)^3} \\ &\leq C\epsilon \|\nabla(\mathbf{u}_\epsilon - \mathbf{u}_{\epsilon,[2]})\|_{L^2(\Omega_\epsilon^\alpha)^3} \|\nabla \mathbf{s}_\epsilon^*\|_{L^2(\Omega_\epsilon^\alpha)^3} + C\epsilon^5 \|\nabla \mathbf{s}_\epsilon^*\|_{L^2(\Omega_\epsilon^\alpha)^3}, \\ \left| \int_{\Omega_\epsilon^\alpha} \frac{\partial \mathbf{D}_\epsilon}{\partial t} \mathbf{s}_\epsilon^* \right| &\leq \left\| \frac{\partial \mathbf{D}_\epsilon}{\partial t} \right\|_{L^2(\Omega_\epsilon^\alpha)^3} \|\mathbf{s}_\epsilon^*\|_{L^2(\Omega_\epsilon^\alpha)^3} \leq \epsilon^2 \left\| \nabla \frac{\partial \mathbf{D}_\epsilon}{\partial t} \right\|_{L^2(\Omega_\epsilon^\alpha)^3} \|\nabla \mathbf{s}_\epsilon^*\|_{L^2(\Omega_\epsilon^\alpha)^3}, \\ \left| \int_{\Omega_\epsilon^\alpha} \nabla \mathbf{s}_\epsilon^* \nabla \mathbf{D}_\epsilon \right| &\leq \|\nabla \mathbf{s}_\epsilon^*\|_{L^2(\Omega_\epsilon^\alpha)^3} \|\nabla \mathbf{D}_\epsilon\|_{L^2(\Omega_\epsilon^\alpha)^3}, \\ \left| \int_{\Omega_\epsilon^\alpha} \operatorname{div} \mathbf{D}_\epsilon \operatorname{div} \mathbf{s}_\epsilon^* \right| &\leq \|\nabla \mathbf{D}_\epsilon\|_{L^2(\Omega_\epsilon^\alpha)^3} \|\nabla \mathbf{s}_\epsilon^*\|_{L^2(\Omega_\epsilon^\alpha)^3}, \\ \left| \int_{\Omega_\epsilon^\alpha} \mathbf{s}_\epsilon^* \mathbf{D}_\epsilon \right| &\leq \|\mathbf{s}_\epsilon^*\|_{L^2(\Omega_\epsilon^\alpha)} \|\mathbf{D}_\epsilon\|_{L^2(\Omega_\epsilon^\alpha)} \leq C\epsilon^2 \|\nabla \mathbf{s}_\epsilon^*\|_{L^2(\Omega_\epsilon^\alpha)^3} \|\nabla \mathbf{D}_\epsilon\|_{L^2(\Omega_\epsilon^\alpha)^3}, \\ \left| \int_{\Omega_\epsilon^\alpha} \boldsymbol{\xi}_\epsilon \mathbf{s}_\epsilon^* \right| &\leq \|\boldsymbol{\xi}_\epsilon\|_{L^2(\Omega_\epsilon^\alpha)^3} \|\mathbf{s}_\epsilon\|_{L^2(\Omega_\epsilon^\alpha)^3} \leq C\epsilon \|\boldsymbol{\xi}_\epsilon\|_{L^2(\Omega_\epsilon^\alpha)^3} \|\nabla \mathbf{s}_\epsilon^*\|_{L^2(\Omega_\epsilon^\alpha)^3}. \end{aligned} \quad (4.100)$$

Applying the estimates (4.100) and Young's inequality on the right hand–side of equation (4.99), integrating over  $t$  and using (4.98), we get

$$\sup_{t \in [0, T]} \|\mathbf{s}_\epsilon^*(\cdot, t)\|_{L^2(\Omega_\epsilon^\alpha)^3}^2 + \int_0^T \|\nabla \mathbf{s}_\epsilon^*\|_{L^2(\Omega_\epsilon^\alpha)^3}^2 \leq C\epsilon^2 \int_0^t \|\nabla(\mathbf{u}_\epsilon - \mathbf{u}_{\epsilon, [2]})\|_{L^2(\Omega_\epsilon^\alpha)^3}^2 + C\epsilon^{10}. \quad (4.101)$$

Differentiating identity (4.97)<sub>1</sub> with respect to  $t$  and using  $\frac{\partial \mathbf{s}_\epsilon^*}{\partial t} = \frac{\partial \mathbf{s}_\epsilon}{\partial t} - \frac{\partial \mathbf{D}_\epsilon}{\partial t}$  as a test function leads to:

$$\begin{aligned} & \frac{1}{2} \frac{d}{dt} \int_{\Omega_\epsilon^\alpha} \left| \frac{\partial \mathbf{s}_\epsilon^*}{\partial t} \right|^2 + \delta \int_{\Omega_\epsilon^\alpha} \left| \nabla \frac{\partial \mathbf{s}_\epsilon^*}{\partial t} \right|^2 + \beta \int_{\Omega_\epsilon^\alpha} \left( \operatorname{div} \frac{\partial \mathbf{s}_\epsilon^*}{\partial t} \right)^2 + 2a \int_{\Omega_\epsilon^\alpha} \left| \frac{\partial \mathbf{s}_\epsilon^*}{\partial t} \right|^2 \\ &= a \int_{\Omega_\epsilon^\alpha} \operatorname{rot} \left( \frac{\partial \mathbf{u}_\epsilon}{\partial t} - \frac{\partial \mathbf{u}_{\epsilon, [1]}}{\partial t} \right) \frac{\partial \mathbf{s}_\epsilon^*}{\partial t} - \int_{\Omega_\epsilon^\alpha} \frac{\partial^2 \mathbf{D}_\epsilon}{\partial t^2} \frac{\partial \mathbf{s}_\epsilon^*}{\partial t} - \alpha \int_{\Omega_\epsilon^\alpha} \nabla \frac{\partial \mathbf{s}_\epsilon^*}{\partial t} \nabla \frac{\partial \mathbf{D}_\epsilon}{\partial t} \\ & - \beta \int_{\Omega_\epsilon^\alpha} \operatorname{div} \frac{\partial \mathbf{D}_\epsilon}{\partial t} \operatorname{div} \frac{\partial \mathbf{s}_\epsilon^*}{\partial t} - 2a \int_{\Omega_\epsilon^\alpha} \frac{\partial \mathbf{s}_\epsilon^*}{\partial t} \frac{\partial \mathbf{D}_\epsilon}{\partial t} - \int_{\Omega_\epsilon^\alpha} \frac{\partial \boldsymbol{\xi}_\epsilon}{\partial t} \frac{\partial \mathbf{s}_\epsilon^*}{\partial t}. \end{aligned} \quad (4.102)$$

Similarly as above, estimating the terms on the right–hand side of (4.102), applying Young's inequality and integrating over  $t$  we obtain:

$$\sup_{t \in [0, T]} \left\| \frac{\partial \mathbf{s}_\epsilon^*}{\partial t}(\cdot, t) \right\|_{L^2(\Omega_\epsilon^\alpha)^3}^2 + \int_0^T \left\| \nabla \frac{\partial \mathbf{s}_\epsilon^*}{\partial t} \right\|_{L^2(\Omega_\epsilon^\alpha)^3}^2 \leq C\epsilon^2 \int_0^T \left\| \nabla \left( \frac{\partial \mathbf{u}_\epsilon}{\partial t} - \frac{\partial \mathbf{u}_{\epsilon, [2]}}{\partial t} \right) \right\|_{L^2(\Omega_\epsilon^\alpha)^3}^2 + C\epsilon^{10}. \quad (4.103)$$

The problem satisfied by the asymptotic approximation  $\mathbf{u}_{\epsilon, [2]}$  reads:

$$\begin{aligned} & \frac{\partial \mathbf{u}_{\epsilon, [2]}}{\partial t} - \mu \Delta \mathbf{u}_{\epsilon, [2]} + \nabla p_{\epsilon, [2]} = a \operatorname{rot} \mathbf{w}_{\epsilon, [1]} + \mathbf{F} + \mathbf{E}_\epsilon \text{ in } \Omega_\epsilon^\alpha, \\ & \operatorname{div} \mathbf{u}_{\epsilon, [2]} = \pi_\epsilon \text{ in } \Omega_\epsilon^\alpha, \\ & \mathbf{u}_{\epsilon, [2]} = \mathbf{0} \text{ on } \Gamma_\epsilon^\alpha, \\ & \mathbf{u}_{\epsilon, [2]} = \epsilon^2 \mathbf{h}_0 + \mathbf{r}_0 \text{ on } \Sigma_\epsilon^0, \quad \mathbf{u}_{\epsilon, [2]} = \epsilon^2 \mathbf{h}_l + \mathbf{r}_l \text{ on } \Sigma_\epsilon^l, \\ & \mathbf{u}_{\epsilon, [2]}(\cdot, 0) = \mathbf{0}, \end{aligned} \quad (4.104)$$

where we have  $\|\mathbf{E}_\epsilon\|_{L^2(0, T; L^2(\Omega_\epsilon^\alpha)^3)} = \mathcal{O}(\epsilon^4)$ ,  $\|\pi_\epsilon\|_{L^2(0, T; L^2(\Omega_\epsilon^\alpha)^3)} = \mathcal{O}(\epsilon^{9/2})$  and  $\|\mathbf{r}_i^\epsilon\|_{L^2(0, T; H^{1/2}(\Sigma_\epsilon^i)^3)} = \mathcal{O}(\epsilon^{11/2})$ ,  $i = 0, l$ .

Denoting  $\mathbf{R}_\epsilon = \mathbf{u}_\epsilon - \mathbf{u}_{\epsilon, [2]}$ ,  $r_\epsilon = p_\epsilon - p_{\epsilon, [2]}$  and subtracting (4.1)<sub>1</sub>, (4.1)<sub>2</sub>, (4.2)<sub>1</sub>, (4.2)<sub>3,1</sub> and (4.104), we obtain:

$$\begin{aligned} & \frac{\partial \mathbf{R}_\epsilon}{\partial t} - \mu \Delta \mathbf{R}_\epsilon + \nabla r_\epsilon = a \operatorname{rot}(\mathbf{w}_\epsilon - \mathbf{w}_{\epsilon, [1]}) - \mathbf{E}_\epsilon \text{ in } \Omega_\epsilon^\alpha, \\ & \operatorname{div} \mathbf{R}_\epsilon = -\pi_\epsilon \text{ in } \Omega_\epsilon^\alpha, \\ & \mathbf{R}_\epsilon = \mathbf{0} \text{ on } \Gamma_\epsilon^\alpha, \\ & \mathbf{R}_\epsilon = -\mathbf{r}_0 \text{ on } \Sigma_\epsilon^0, \quad \mathbf{R}_\epsilon = -\mathbf{r}_l \text{ on } \Sigma_\epsilon^l, \\ & \mathbf{R}_\epsilon(\cdot, 0) = \mathbf{0}. \end{aligned} \quad (4.105)$$

It is important to emphasize that the divergence estimate  $\|\pi_\epsilon\|_{L^2(0,T;L^2(\Omega_\epsilon^\alpha))} = \mathcal{O}(\epsilon^{9/2})$  cannot be improved in the general case, due to its structure (see (4.62)–(4.65)). However, under certain assumptions on  $\kappa$ ,  $\alpha$  and  $\mathbf{h}_0^\epsilon$ ,  $\mathbf{h}_l^\epsilon$ ,  $\mathbf{F}$  and  $\mathbf{G}$ , this estimate can, in fact, be improved providing better overall estimates. These considerations are addressed in (4.66)–(4.72) in Section 4.3.3 and Remark 4.7 at the end of this Section.

Let us define  $\boldsymbol{\zeta}_\epsilon$  as the solution of the problem

$$\begin{aligned} \operatorname{div} \boldsymbol{\zeta}_\epsilon &= -\pi_\epsilon \text{ in } \Omega_\epsilon^\alpha, \\ \boldsymbol{\zeta}_\epsilon &= \mathbf{0} \text{ on } \Gamma_\epsilon^\alpha, \\ \boldsymbol{\zeta}_\epsilon &= -\mathbf{r}_0 \text{ on } \Sigma_\epsilon^0 \quad \boldsymbol{\zeta}_\epsilon = -\mathbf{r}_l \text{ on } \Sigma_\epsilon^l, \end{aligned}$$

satisfying the following estimates (see Lemma 4.3):

$$\|\nabla \boldsymbol{\zeta}_\epsilon\|_{L^2(0,T;L^2(\Omega_\epsilon^\alpha)^3)} + \left\| \nabla \frac{\partial \boldsymbol{\zeta}_\epsilon}{\partial t} \right\|_{L^2(0,T;L^2(\Omega_\epsilon^\alpha)^3)} + \left\| \nabla \frac{\partial^2 \boldsymbol{\zeta}_\epsilon}{\partial t^2} \right\|_{L^2(0,T;L^2(\Omega_\epsilon^\alpha)^3)} \leq C\epsilon^{7/2}. \quad (4.106)$$

Multiplying the equation (4.105)<sub>1</sub> with function  $\mathbf{R}_\epsilon^* = \mathbf{R}_\epsilon - \boldsymbol{\zeta}_\epsilon$  and integrating over  $\Omega_\epsilon^\alpha$ , we obtain:

$$\begin{aligned} \frac{1}{2} \frac{d}{dt} \|\mathbf{R}_\epsilon^*\|_{L^2(\Omega_\epsilon^\alpha)}^2 + \mu \|\nabla \mathbf{R}_\epsilon^*\|_{L^2(\Omega_\epsilon^\alpha)}^2 &\leq - \int_{\Omega_\epsilon^\alpha} \frac{\partial \boldsymbol{\zeta}_\epsilon}{\partial t} \mathbf{R}_\epsilon^* + \mu \int_{\Omega_\epsilon^\alpha} \nabla \boldsymbol{\zeta}_\epsilon \nabla \mathbf{R}_\epsilon^* \\ &\quad + a \int_{\Omega_\epsilon^\alpha} \operatorname{rot}(\mathbf{w}_\epsilon - \mathbf{w}_{\epsilon,[1]}) \mathbf{R}_\epsilon^* - \int_{\Omega_\epsilon^\alpha} \mathbf{E}_\epsilon \mathbf{R}_\epsilon^*. \end{aligned} \quad (4.107)$$

Estimating the terms on the right-hand side of equation (4.107) using Poincaré's inequality (4.73) yields

$$\begin{aligned} \left| \int_{\Omega_\epsilon^\alpha} \frac{\partial \boldsymbol{\zeta}_\epsilon}{\partial t} \mathbf{R}_\epsilon^* \right| &\leq \left\| \frac{\partial \boldsymbol{\zeta}_\epsilon}{\partial t} \right\|_{L^2(\Omega_\epsilon^\alpha)^3} \|\mathbf{R}_\epsilon^*\|_{L^2(\Omega_\epsilon^\alpha)^3} \leq C\epsilon^2 \left\| \nabla \frac{\partial \boldsymbol{\zeta}_\epsilon}{\partial t} \right\|_{L^2(\Omega_\epsilon^\alpha)^3} \|\nabla \mathbf{R}_\epsilon^*\|_{L^2(\Omega_\epsilon^\alpha)^3}, \\ \left| \int_{\Omega_\epsilon^\alpha} \nabla \boldsymbol{\zeta}_\epsilon \nabla \mathbf{R}_\epsilon^* \right| &\leq \|\nabla \boldsymbol{\zeta}_\epsilon\|_{L^2(\Omega_\epsilon^\alpha)^3} \|\nabla \mathbf{R}_\epsilon^*\|_{L^2(\Omega_\epsilon^\alpha)^3}, \\ \left| \int_{\Omega_\epsilon^\alpha} \operatorname{rot}(\mathbf{w}_\epsilon - \mathbf{w}_{\epsilon,[1]}) \mathbf{R}_\epsilon^* \right| &\leq C \|\nabla(\mathbf{w}_\epsilon - \mathbf{w}_{\epsilon,[1]})\|_{L^2(\Omega_\epsilon^\alpha)^3} \|\mathbf{R}_\epsilon^*\|_{L^2(\Omega_\epsilon^\alpha)^3} \\ &\leq C \left( \|\nabla(\mathbf{w}_\epsilon - \mathbf{w}_{\epsilon,[2]})\|_{L^2(\Omega_\epsilon^\alpha)^3} + \|\nabla(\mathbf{w}_{\epsilon,[2]} - \mathbf{w}_{\epsilon,[1]})\|_{L^2(\Omega_\epsilon^\alpha)^3} \right) \|\mathbf{R}_\epsilon^*\|_{L^2(\Omega_\epsilon^\alpha)^3} \\ &\leq C\epsilon \|\nabla \mathbf{s}_\epsilon^*\|_{L^2(\Omega_\epsilon^\alpha)^3} \|\nabla \mathbf{R}_\epsilon^*\|_{L^2(\Omega_\epsilon^\alpha)^3} + C\epsilon^5 \|\nabla \mathbf{R}_\epsilon^*\|_{L^2(\Omega_\epsilon^\alpha)^3}, \\ \left| \int_{\Omega_\epsilon^\alpha} \mathbf{E}_\epsilon \mathbf{R}_\epsilon^* \right| &\leq \|\mathbf{E}_\epsilon\|_{L^2(\Omega_\epsilon^\alpha)^3} \|\mathbf{R}_\epsilon^*\|_{L^2(\Omega_\epsilon^\alpha)^3} \leq C\epsilon \|\mathbf{E}_\epsilon\|_{L^2(\Omega_\epsilon^\alpha)^3} \|\nabla \mathbf{R}_\epsilon^*\|_{L^2(\Omega_\epsilon^\alpha)^3}. \end{aligned} \quad (4.108)$$

Applying the estimates (4.108) and Young's inequality on the right-hand side of (4.107), integrating over  $t$  and using (4.101), (4.106), for sufficiently small  $\epsilon$  we get:

$$\sup_{t \in [0, T]} \|\mathbf{R}_\epsilon^*(\cdot, t)\|_{L^2(\Omega_\epsilon^\alpha)}^2 + \int_0^T \|\nabla \mathbf{R}_\epsilon^*\|_{L^2(\Omega_\epsilon^\alpha)}^2 \leq C\epsilon^7, \quad (4.109)$$

and from (4.101) we now easily get

$$\sup_{t \in [0, T]} \|\mathbf{s}_\epsilon^*(\cdot, t)\|_{L^2(\Omega_\epsilon^\alpha)^3}^2 + \int_0^T \|\nabla \mathbf{s}_\epsilon^*\|_{L^2(\Omega_\epsilon^\alpha)^3}^2 \leq C\epsilon^9, \quad (4.110)$$

implying (4.95)<sub>1</sub> and (4.95)<sub>3</sub>.

Differentiating equation (4.105)<sub>1</sub> with respect to  $t$ , multiplying by  $\frac{\partial \mathbf{R}_\epsilon^*}{\partial t} = \frac{\partial \mathbf{R}_\epsilon}{\partial t} - \frac{\partial \zeta_\epsilon}{\partial t}$  and integrating over  $\Omega_\epsilon^\alpha$ , we get:

$$\begin{aligned} & \frac{1}{2} \frac{d}{dt} \int_{\Omega_\epsilon^\alpha} \left| \frac{\partial \mathbf{R}_\epsilon^*}{\partial t} \right|^2 + \mu \int_{\Omega_\epsilon^\alpha} \left| \nabla \frac{\partial \mathbf{R}_\epsilon^*}{\partial t} \right|^2 \\ = & a \int_{\Omega_\epsilon^\alpha} \operatorname{rot} \left( \frac{\partial \mathbf{w}_\epsilon}{\partial t} - \frac{\partial \mathbf{w}_{\epsilon, [1]}}{\partial t} \right) \frac{\partial \mathbf{R}_\epsilon^*}{\partial t} - \int_{\Omega_\epsilon^\alpha} \frac{\partial \mathbf{E}_\epsilon}{\partial t} \frac{\partial \mathbf{R}_\epsilon^*}{\partial t} - \int_{\Omega_\epsilon^\alpha} \frac{\partial^2 \zeta_\epsilon}{\partial t^2} \frac{\partial \mathbf{R}_\epsilon^*}{\partial t} - \alpha \int_{\Omega_\epsilon^\alpha} \nabla \frac{\partial \zeta_\epsilon}{\partial t} \nabla \frac{\partial \mathbf{R}_\epsilon^*}{\partial t}. \end{aligned} \quad (4.111)$$

In much the same way, using Poincaré's and Young's inequality to estimate the terms on the right-hand side of (4.111), integrating with respect to  $t$  and using (4.103), (4.106), for sufficiently small  $\epsilon$  we obtain:

$$\sup_{t \in [0, T]} \left\| \frac{\partial \mathbf{R}_\epsilon^*}{\partial t}(\cdot, t) \right\|_{L^2(\Omega_\epsilon^\alpha)^3}^2 + \int_0^T \left\| \nabla \frac{\partial \mathbf{R}_\epsilon^*}{\partial t} \right\|_{L^2(\Omega_\epsilon^\alpha)^3}^2 \leq C\epsilon^7. \quad (4.112)$$

From (4.103), it follows

$$\sup_{t \in [0, T]} \left\| \frac{\partial \mathbf{s}_\epsilon^*}{\partial t}(\cdot, t) \right\|_{L^2(\Omega_\epsilon^\alpha)^3}^2 + \int_0^T \left\| \nabla \frac{\partial \mathbf{s}_\epsilon^*}{\partial t} \right\|_{L^2(\Omega_\epsilon^\alpha)^3}^2 \leq C\epsilon^9, \quad (4.113)$$

thus obtaining the estimates (4.95)<sub>2</sub> and (4.95)<sub>4</sub>.

Let now  $\mathbf{d}_\epsilon$  be the solution of the problem

$$\begin{aligned} \operatorname{div} \mathbf{d}_\epsilon &= r_\epsilon \text{ in } \Omega_\epsilon^\alpha, \\ \mathbf{d}_\epsilon &= \mathbf{0} \text{ on } \partial \Omega_\epsilon^\alpha. \end{aligned} \quad (4.114)$$

Supposing that  $\int_{\Omega_\epsilon^\alpha} r_\epsilon = 0$ , for all  $t$ , it follows from Lemma (4.3) that the problem (4.114) has at least one solution satisfying the estimate

$$\|\nabla \mathbf{d}_\epsilon\|_{L^2(0, T; L^2(\Omega_\epsilon^\alpha)^3)} \leq \frac{C}{\epsilon} \|r_\epsilon\|_{L^2(0, T; L^2(\Omega_\epsilon^\alpha))}. \quad (4.115)$$



Multiplying the equation (4.105)<sub>1</sub> by  $\mathbf{d}_\epsilon$  and integrating over  $\Omega_\epsilon^\alpha$  yields

$$\begin{aligned} \|r_\epsilon\|_{L^2(\Omega_\epsilon^\alpha)}^2 &= \int_{\Omega_\epsilon^\alpha} \frac{\partial \mathbf{R}_\epsilon^*}{\partial t} \mathbf{d}_\epsilon + \mu \int_{\Omega_\epsilon^\alpha} \nabla \mathbf{R}_\epsilon^* \nabla \mathbf{d}_\epsilon - a \int_{\Omega_\epsilon^\alpha} \text{rot}(\mathbf{w}_\epsilon - \mathbf{w}_{\epsilon,[1]}) \mathbf{d}_\epsilon \\ &\quad + \int_{\Omega_\epsilon^\alpha} \mathbf{E}_\epsilon \mathbf{d}_\epsilon + \int_{\Omega_\epsilon^\alpha} \frac{\partial \boldsymbol{\zeta}_\epsilon}{\partial t} \mathbf{d}_\epsilon + \mu \int_{\Omega_\epsilon^\alpha} \nabla \boldsymbol{\zeta}_\epsilon \nabla \mathbf{d}_\epsilon. \end{aligned} \quad (4.116)$$

Estimating the terms on the right-hand of (4.116) and using Poincaré's inequality yields:

$$\begin{aligned} \left| \int_{\Omega_\epsilon^\alpha} \frac{\partial \mathbf{R}_\epsilon^*}{\partial t} \mathbf{d}_\epsilon \right| &\leq \left\| \frac{\partial \mathbf{R}_\epsilon^*}{\partial t} \right\|_{L^2(\Omega_\epsilon^\alpha)^3} \|\mathbf{d}_\epsilon\|_{L^2(\Omega_\epsilon^\alpha)^3} \leq C\epsilon^2 \left\| \nabla \frac{\partial \mathbf{R}_\epsilon^*}{\partial t} \right\|_{L^2(\Omega_\epsilon^\alpha)^3} \|\nabla \mathbf{d}_\epsilon\|_{L^2(\Omega_\epsilon^\alpha)^3}, \\ \left| \int_{\Omega_\epsilon^\alpha} \nabla \mathbf{R}_\epsilon^* \nabla \mathbf{d}_\epsilon \right| &\leq \|\nabla \mathbf{R}_\epsilon^*\|_{L^2(\Omega_\epsilon^\alpha)^3} \|\nabla \mathbf{d}_\epsilon\|_{L^2(\Omega_\epsilon^\alpha)^3}, \\ \left| \int_{\Omega_\epsilon^\alpha} \text{rot}(\mathbf{w}_\epsilon - \mathbf{w}_{\epsilon,[1]}) \mathbf{d}_\epsilon \right| &\leq \epsilon \|\nabla(\mathbf{w}_\epsilon - \mathbf{w}_{\epsilon,[1]})\|_{L^2(\Omega_\epsilon^\alpha)^3} \|\nabla \mathbf{d}_\epsilon\|_{L^2(\Omega_\epsilon^\alpha)^3} \\ &\leq C\epsilon \left( \|\nabla(\mathbf{w}_\epsilon - \mathbf{w}_{\epsilon,[2]})\|_{L^2(\Omega_\epsilon^\alpha)^3} + \|\nabla(\mathbf{w}_{\epsilon,[2]} - \mathbf{w}_{\epsilon,[1]})\|_{L^2(\Omega_\epsilon^\alpha)^3} \right) \|\nabla \mathbf{d}_\epsilon\|_{L^2(\Omega_\epsilon^\alpha)^3} \\ &\leq C\epsilon \|\nabla \mathbf{s}_\epsilon^*\|_{L^2(\Omega_\epsilon^\alpha)^3} \|\nabla \mathbf{d}_\epsilon\|_{L^2(\Omega_\epsilon^\alpha)^3} + C\epsilon^5 \|\nabla \mathbf{d}_\epsilon\|_{L^2(\Omega_\epsilon^\alpha)^3}, \\ \left| \int_{\Omega_\epsilon^\alpha} \mathbf{E}_\epsilon \mathbf{d}_\epsilon \right| &\leq \|\mathbf{E}_\epsilon\|_{L^2(\Omega_\epsilon^\alpha)^3} \|\mathbf{d}_\epsilon\|_{L^2(\Omega_\epsilon^\alpha)^3} \leq C\epsilon \|\mathbf{E}_\epsilon\|_{L^2(\Omega_\epsilon^\alpha)^3} \|\nabla \mathbf{d}_\epsilon\|_{L^2(\Omega_\epsilon^\alpha)^3}, \\ \left| \int_{\Omega_\epsilon^\alpha} \frac{\partial \boldsymbol{\zeta}_\epsilon}{\partial t} \mathbf{d}_\epsilon \right| &\leq \left\| \frac{\partial \boldsymbol{\zeta}_\epsilon}{\partial t} \right\|_{L^2(\Omega_\epsilon^\alpha)^3} \|\mathbf{d}_\epsilon\|_{L^2(\Omega_\epsilon^\alpha)^3} \leq C\epsilon^2 \left\| \frac{\partial \nabla \boldsymbol{\zeta}_\epsilon}{\partial t} \right\|_{L^2(\Omega_\epsilon^\alpha)^3} \|\nabla \mathbf{d}_\epsilon\|_{L^2(\Omega_\epsilon^\alpha)^3}, \\ \left| \int_{\Omega_\epsilon^\alpha} \nabla \boldsymbol{\zeta}_\epsilon \nabla \mathbf{d}_\epsilon \right| &\leq \|\nabla \boldsymbol{\zeta}_\epsilon\|_{L^2(\Omega_\epsilon^\alpha)^3} \|\nabla \mathbf{d}_\epsilon\|_{L^2(\Omega_\epsilon^\alpha)^3}. \end{aligned} \quad (4.117)$$

Applying (4.117) and Young's inequality on the right-hand side of (4.116), integrating over  $t$  and using (4.106), (4.109), (4.110), (4.112) and (4.115), we finally obtain:

$$\|r_\epsilon\|_{L^2(0,T;L^2(\Omega_\epsilon^\alpha))} \leq C\epsilon^{5/2}, \quad (4.118)$$

completing the proof. □

**Remark 4.7.** *If we assume  $\kappa$  and  $\alpha$  to be constant, due to consideration in Section 4.3.3 (see (4.66)), following the proof of Theorem 4.6, we can improve the estimates (4.95) to obtain:*

$$\begin{aligned} \|\mathbf{u}_\epsilon - \mathbf{u}_{\epsilon,[2]}\|_{L^\infty(0,T;L^2(\Omega_\epsilon^\alpha)^3)} + \|\nabla(\mathbf{u}_\epsilon - \mathbf{u}_{\epsilon,[2]})\|_{L^2(0,T;L^2(\Omega_\epsilon^\alpha)^3)} &\leq C\epsilon^4, \\ \left\| \frac{\partial \mathbf{u}_\epsilon}{\partial t} - \frac{\partial \mathbf{u}_{\epsilon,[2]}}{\partial t} \right\|_{L^\infty(0,T;L^2(\Omega_\epsilon^\alpha)^3)} + \left\| \nabla \left( \frac{\partial \mathbf{u}_\epsilon}{\partial t} - \frac{\partial \mathbf{u}_{\epsilon,[2]}}{\partial t} \right) \right\|_{L^2(0,T;L^2(\Omega_\epsilon^\alpha)^3)} &\leq C\epsilon^4, \\ \|\mathbf{w}_\epsilon - \mathbf{w}_{\epsilon,[2]}\|_{L^\infty(0,T;L^2(\Omega_\epsilon^\alpha)^3)} + \|\nabla(\mathbf{w}_\epsilon - \mathbf{w}_{\epsilon,[2]})\|_{L^2(0,T;L^2(\Omega_\epsilon^\alpha)^3)} &\leq C\epsilon^5, \\ \left\| \frac{\partial \mathbf{w}_\epsilon}{\partial t} - \frac{\partial \mathbf{w}_{\epsilon,[2]}}{\partial t} \right\|_{L^\infty(0,T;L^2(\Omega_\epsilon^\alpha)^3)} + \left\| \nabla \left( \frac{\partial \mathbf{w}_\epsilon}{\partial t} - \frac{\partial \mathbf{w}_{\epsilon,[2]}}{\partial t} \right) \right\|_{L^2(0,T;L^2(\Omega_\epsilon^\alpha)^3)} &\leq C\epsilon^5, \\ \|p_\epsilon - p_{\epsilon,[2]}\|_{L^2(0,T;L^2(\Omega_\epsilon^\alpha))} &\leq C\epsilon^3. \end{aligned}$$

If we, additionally, assume that  $\mathbf{f}, \mathbf{g}$  vanish in the neighborhood of  $x_1 = 0$  and  $x_1 = l$ ,  $\int_0^l \mathbf{g} = 0$ , the relations (4.67) hold and take  $P_2(x_1, t) = x_1 p^{bl}(t) + p^{div}(x_1, t)$ , following the procedure given in Section 4.3.3 (see (4.68)–(4.72)), we can even further improve the error estimates. Namely, we get:

$$\begin{aligned} & \|\mathbf{u}_\epsilon - \mathbf{u}_{\epsilon,[2]}\|_{L^\infty(0,T;L^2(\Omega_\epsilon^\alpha)^3)} + \|\nabla(\mathbf{u}_\epsilon - \mathbf{u}_{\epsilon,[2]})\|_{L^2(0,T;L^2(\Omega_\epsilon^\alpha)^3)} \leq C\epsilon^{9/2}, \\ & \left\| \frac{\partial \mathbf{u}_\epsilon}{\partial t} - \frac{\partial \mathbf{u}_{\epsilon,[2]}}{\partial t} \right\|_{L^\infty(0,T;L^2(\Omega_\epsilon^\alpha)^3)} + \left\| \nabla \left( \frac{\partial \mathbf{u}_\epsilon}{\partial t} - \frac{\partial \mathbf{u}_{\epsilon,[2]}}{\partial t} \right) \right\|_{L^2(0,T;L^2(\Omega_\epsilon^\alpha)^3)} \leq C\epsilon^{9/2}, \\ & \|\mathbf{w}_\epsilon - \mathbf{w}_{\epsilon,[2]}\|_{L^\infty(0,T;L^2(\Omega_\epsilon^\alpha)^3)} + \|\nabla(\mathbf{w}_\epsilon - \mathbf{w}_{\epsilon,[2]})\|_{L^2(0,T;L^2(\Omega_\epsilon^\alpha)^3)} \leq C\epsilon^5, \\ & \left\| \frac{\partial \mathbf{w}_\epsilon}{\partial t} - \frac{\partial \mathbf{w}_{\epsilon,[2]}}{\partial t} \right\|_{L^\infty(0,T;L^2(\Omega_\epsilon^\alpha)^3)} + \left\| \nabla \left( \frac{\partial \mathbf{w}_\epsilon}{\partial t} - \frac{\partial \mathbf{w}_{\epsilon,[2]}}{\partial t} \right) \right\|_{L^2(0,T;L^2(\Omega_\epsilon^\alpha)^3)} \leq C\epsilon^5, \\ & \|p_\epsilon - p_{\epsilon,[2]}\|_{L^2(0,T;L^2(\Omega_\epsilon^\alpha))} \leq C\epsilon^{7/2}. \end{aligned}$$



# Appendix A

## Asymptotic Approximation for the Straight Circular Pipe

Following the results from [31], in this Appendix we consider the nonsteady flow of a micropolar fluid in a thin pipe with circular cross-section and external force functions dependent only on time. We derive the explicit expressions for the asymptotic approximation of order  $J = 2$  and provide the numerical examples.

### A.1 Setting of the Problem

Let  $\epsilon$  be a small positive parameter. We consider a thin straight pipe

$$\Omega_\epsilon = \{x \in \mathbb{R}^3 : x_1 \in \mathbb{R}, x' = (x_2, x_3) \in B_\epsilon = \epsilon B\},$$

where

$$B = \{x' \in \mathbb{R}^2 : |x'| < R\},$$

is the circular cross-section of the pipe with constant diameter  $R > 0$ . We denote by  $(x_1, (x_2, x_3)) \equiv (x_1, x')$  the Cartesian coordinates, with  $x_1$  being the direction coinciding with the axis of the pipe (see Figure A.1).

We consider the following system of equations describing the nonsteady micropolar fluid flow:

$$\begin{aligned} \frac{\partial \mathbf{u}_\epsilon}{\partial t} - (\nu + \nu_r)\Delta \mathbf{u}_\epsilon + (\mathbf{u}_\epsilon \cdot \nabla)\mathbf{u}_\epsilon + \nabla p_\epsilon &= 2\nu_r \text{rot} \mathbf{w}_\epsilon + \mathbf{f}_\epsilon, \\ \text{div} \mathbf{u}_\epsilon &= 0, \quad x \in \Omega_\epsilon, \\ \frac{\partial \mathbf{w}_\epsilon}{\partial t} - (c_a + c_d)\Delta \mathbf{w}_\epsilon + (\mathbf{u}_\epsilon \cdot \nabla)\mathbf{w}_\epsilon - (c_0 + c_d - c_a)\nabla \text{div} \mathbf{w}_\epsilon + 4\mu_r \mathbf{w}_\epsilon &= 2\nu_r \text{rot} \mathbf{u}_\epsilon + \mathbf{g}_\epsilon. \end{aligned} \tag{A.1}$$

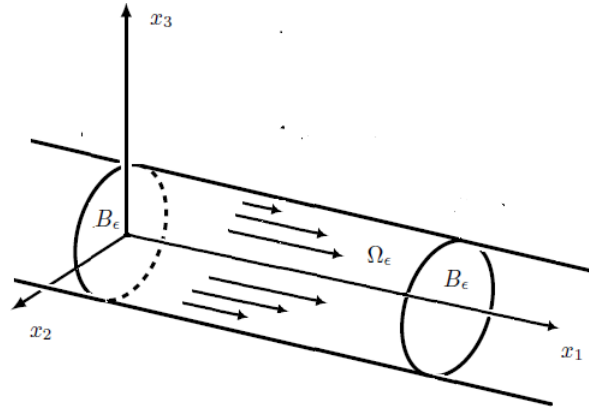

**Figure A.1:** The considered flow problem.

To complete the problem, we impose the following boundary and initial conditions

$$\begin{aligned} \mathbf{u}_\epsilon &= 0, \quad \mathbf{w}_\epsilon = 0 \quad \text{on } \partial\Omega_\epsilon, \\ \mathbf{v}_\epsilon(x, 0) &= \mathbf{a}_\epsilon(x), \quad \mathbf{w}_\epsilon(x, 0) = \mathbf{b}_\epsilon(x), \end{aligned} \tag{A.2}$$

along with the flux condition

$$\int_{B_\epsilon} u_\epsilon^1(x_1, x', t) dx' = F(t). \tag{A.3}$$

The positive constants are the Newtonian viscosity  $\nu$ , the microrotation viscosity  $\nu_r$ , while  $c_0, c_a$  and  $c_d$  represent the coefficients of the angular viscosities. To simplify the notation, we abbreviate:  $\mu = \nu + \nu_r$ ,  $\alpha = c_a + c_d$ ,  $\beta = c_0 + c_d - c_a$ ,  $a = 2\nu_r$ . The external sources of linear and angular momentum are given by the functions  $\mathbf{f}_\epsilon = (f_\epsilon^1, f_\epsilon^2, f_\epsilon^3)$  and  $\mathbf{g}_\epsilon = (g_\epsilon^1, g_\epsilon^2, g_\epsilon^3)$ , respectively.

We assume that the solution of the problem (A.1)–(A.3) has the micropolar Poiseuille form, namely:

$$\mathbf{u}_\epsilon(x, t) = (v_\epsilon(x', t), 0, 0), \quad \mathbf{w}^\epsilon(x, t) = (0, w_\epsilon^2(x', t), w_\epsilon^3(x', t)), \quad p_\epsilon(x, t) = -q(t)x_1 + p_0(t), \tag{A.4}$$

where  $p_0(t)$  is an arbitrary function of  $t$ . We also assume that  $\mathbf{a}_\epsilon = (a_\epsilon^1, 0, 0)$ ,  $\mathbf{b}_\epsilon = (0, b_\epsilon^2, b_\epsilon^3)$ ,  $\mathbf{f}_\epsilon = (f_\epsilon^1, 0, 0)$ ,  $\mathbf{g}_\epsilon = (0, g_\epsilon^2, g_\epsilon^3)$ , with  $a_\epsilon^1 = a_\epsilon(x')$ ,  $b_\epsilon^2 = b_\epsilon^2(x')$ ,  $b_\epsilon^3 = b_\epsilon^3(x')$ ,  $f_\epsilon^1 = f_\epsilon(x', t)$ ,  $g_\epsilon^2(x', t)$  and  $g_\epsilon^3(x', t)$  being independent of the longitudinal variable  $x_1 \in \mathbb{R}$ .

Substituting the micropolar Poiseuille solution (A.4) into the system (A.1)–(A.3), we obtain the following initial boundary value problem for  $x' \in B_\epsilon$ :

$$\begin{aligned} \frac{\partial p_\epsilon}{\partial x_2} &= 0, \quad \frac{\partial p_\epsilon}{\partial x_3} = 0, \\ \frac{\partial v_\epsilon}{\partial t} - \mu \Delta_{x'} v_\epsilon - q(t) &= a \left( \frac{\partial w_\epsilon^3}{\partial x_2} - \frac{\partial w_\epsilon^2}{\partial x_3} \right) + f_\epsilon, \\ \frac{\partial w_\epsilon^2}{\partial t} - \alpha \Delta_{x'} w_\epsilon^2 - \beta \frac{\partial}{\partial x_2} \left( \frac{\partial w_\epsilon^2}{\partial x_2} + \frac{\partial w_\epsilon^3}{\partial x_3} \right) + 2a w_\epsilon^2 &= a \frac{\partial v_\epsilon}{\partial x_3} + g_\epsilon^2, \\ \frac{\partial w_\epsilon^3}{\partial t} - \alpha \Delta_{x'} w_\epsilon^3 - \beta \frac{\partial}{\partial x_3} \left( \frac{\partial w_\epsilon^2}{\partial x_2} + \frac{\partial w_\epsilon^3}{\partial x_3} \right) + 2a w_\epsilon^3 &= -a \frac{\partial v_\epsilon}{\partial x_2} + g_\epsilon^3, \end{aligned} \tag{A.5}$$

where  $\Delta_{x'} v = \frac{\partial^2 v}{\partial x_2^2} + \frac{\partial^2 v}{\partial x_3^2}$ . The corresponding boundary conditions read:

$$\begin{aligned} v_\epsilon|_{\partial B_\epsilon} &= 0, \quad w_\epsilon^2|_{\partial B_\epsilon} = 0, \quad w_\epsilon^3|_{\partial B_\epsilon} = 0, \\ v_\epsilon(x', 0) &= a_\epsilon(x'), \quad w_\epsilon^2(x', 0) = b_\epsilon^2(x'), \quad w_\epsilon^3(x', 0) = b_\epsilon^3(x'), \end{aligned} \tag{A.6}$$

with given flux rate:

$$\int_{B_\epsilon} v_\epsilon(x', t) dx' = F(t). \tag{A.7}$$

Following the idea from [26]–[27], we represent the solution

$$(v_\epsilon(x', t), \hat{\mathbf{w}}_\epsilon(x', t)) = (v_\epsilon(x', t), w_\epsilon^2(x', t), w_\epsilon^3(x', t)),$$

as:

$$v_\epsilon(x', t) = V_\epsilon^1(x', t) + V_\epsilon^2(x', t), \quad \hat{\mathbf{w}}_\epsilon(x', t) = \mathbf{W}_\epsilon^a(x', t) + \mathbf{W}_\epsilon^b(x', t).$$

Here  $(V_\epsilon^1(x', t), \mathbf{W}_\epsilon^a(x', t)) = (V_\epsilon^1(x', t), W_\epsilon^{2,1}(x', t), W_\epsilon^{3,1}(x', t))$  is the solution of the initial boundary value problem for the micropolar heat equation:

$$\begin{aligned} \frac{\partial V_\epsilon^1}{\partial t} - \mu \Delta_{x'} V_\epsilon^1 &= a \left( \frac{\partial W_\epsilon^{3,1}}{\partial x_2} - \frac{\partial W_\epsilon^{2,1}}{\partial x_3} \right) + f_\epsilon, \\ \frac{\partial W_\epsilon^{2,1}}{\partial t} - \alpha \Delta_{x'} W_\epsilon^{2,1} - \beta \frac{\partial}{\partial x_2} \left( \frac{\partial W_\epsilon^{2,1}}{\partial x_2} + \frac{\partial W_\epsilon^{3,1}}{\partial x_3} \right) + 2a W_\epsilon^{2,1} &= a \frac{\partial V_\epsilon^1}{\partial x_3} + g_\epsilon^2, \\ \frac{\partial W_\epsilon^{3,1}}{\partial t} - \alpha \Delta_{x'} W_\epsilon^{3,1} - \beta \frac{\partial}{\partial x_3} \left( \frac{\partial W_\epsilon^{2,1}}{\partial x_2} + \frac{\partial W_\epsilon^{3,1}}{\partial x_3} \right) + 2a W_\epsilon^{3,1} &= -a \frac{\partial V_\epsilon^1}{\partial x_2} + g_\epsilon^3, \\ V_\epsilon^1|_{\partial B_\epsilon} &= 0, \quad W_\epsilon^{2,1}|_{\partial B_\epsilon} = 0, \quad W_\epsilon^{3,1}|_{\partial B_\epsilon} = 0, \\ V_\epsilon^1(x', 0) &= a_\epsilon(x'), \quad W_\epsilon^{2,1}(x', 0) = b_\epsilon^2(x'), \quad W_\epsilon^{3,1}(x', 0) = b_\epsilon^3(x'). \end{aligned} \tag{A.8}$$

On the other hand,  $(V_\epsilon^2(x', t), \mathbf{W}_\epsilon^b(x', t), q(t)) = (V_\epsilon^2(x', t), W_\epsilon^{2,2}(x', t), W_\epsilon^{3,2}(x', t), q(t))$  denotes the solution of the micropolar inverse problem endowed with the homogeneous initial condition and the given flux rate on the cross-section  $B_\epsilon$ :

$$\begin{aligned}
 \frac{\partial V_\epsilon^2}{\partial t} - \mu \Delta_{x'} V_\epsilon^2 &= a \left( \frac{\partial W_\epsilon^{3,2}}{\partial x_2} - \frac{\partial W_\epsilon^{2,2}}{\partial x_3} \right) + q(t), \\
 \frac{\partial W_\epsilon^{2,2}}{\partial t} - \alpha \Delta_{x'} W_\epsilon^{2,2} - \beta \frac{\partial}{\partial x_2} \left( \frac{\partial W_\epsilon^{2,2}}{\partial x_2} + \frac{\partial W_\epsilon^{3,2}}{\partial x_3} \right) + 2a W_\epsilon^{2,2} &= a \frac{\partial V_\epsilon^2}{\partial x_3}, \\
 \frac{\partial W_\epsilon^{3,2}}{\partial t} - \alpha \Delta_{x'} W_\epsilon^{3,2} - \beta \frac{\partial}{\partial x_3} \left( \frac{\partial W_\epsilon^{2,2}}{\partial x_2} + \frac{\partial W_\epsilon^{3,2}}{\partial x_3} \right) + 2a W_\epsilon^{3,2} &= -a \frac{\partial V_\epsilon^2}{\partial x_2}, \\
 V_\epsilon^2 \Big|_{\partial B_\epsilon} &= 0, \quad W_\epsilon^{2,2} \Big|_{\partial B_\epsilon} = 0, \quad W_\epsilon^{3,2} \Big|_{\partial B_\epsilon} = 0, \\
 V_\epsilon^2(x', 0) &= 0, \quad W_\epsilon^{2,2}(x', 0) = 0, \quad W_\epsilon^{3,2}(x', 0) = 0, \\
 \int_{B_\epsilon} V_\epsilon^2(x', t) dx' &= H(t),
 \end{aligned} \tag{A.9}$$

where

$$H(t) = F(t) - \int_{B_\epsilon} V_\epsilon^1(x', t) dx'.$$

From (A.7) we deduce

$$H(0) = 0. \tag{A.10}$$

Taking into account the problem under consideration, it is plausible to consider the following scaling with respect to small parameter  $\epsilon$ :

$$a_\epsilon, b_\epsilon^2, b_\epsilon^3 \sim \epsilon^2, \quad f_\epsilon \sim 1, \quad g_\epsilon^2 \sim 1, \quad g_\epsilon^3 \sim 1, \quad F \sim \epsilon^4.$$

In view of that, we expand

$$\begin{aligned}
 \tilde{a}(y') &= \epsilon^2 \tilde{a}_0(y') + \epsilon^3 \tilde{a}_1(y') + \epsilon^4 \tilde{a}_2(y'), \\
 \tilde{b}^2(y') &= \epsilon^2 \tilde{b}_0^2(y') + \epsilon^3 \tilde{b}_1^2(y') + \epsilon^4 \tilde{b}_2^2(y'), \quad \tilde{b}^3(y') = \epsilon^2 \tilde{b}_0^3(y') + \epsilon^3 \tilde{b}_1^3(y') + \epsilon^4 \tilde{b}_2^3(y'), \\
 \tilde{f}(y', t) &= \tilde{f}_0(y', t) + \epsilon \tilde{f}_1(y', t) + \epsilon^2 \tilde{f}_2(y', t), \\
 \tilde{g}^2(y', t) &= \tilde{g}_0^2(y', t) + \epsilon \tilde{g}_1^2(y', t) + \epsilon^2 \tilde{g}_2^2(y', t), \quad \tilde{g}^3(y', t) = \tilde{g}_0^3(y', t) + \epsilon \tilde{g}_1^3(y', t) + \epsilon^2 \tilde{g}_2^3(y', t), \\
 F(t) &= \epsilon^4 F_0(t) + \epsilon^5 F_1(t) + \epsilon^6 F_2(t),
 \end{aligned} \tag{A.11}$$

and consider the problem (A.5)–(A.7) with

$$\begin{aligned}
 a_\epsilon(x) &= \tilde{a}\left(\frac{x'}{\epsilon}\right), \quad b_\epsilon^2(x) = \tilde{b}^2\left(\frac{x'}{\epsilon}\right), \quad b_\epsilon^3(x) = \tilde{b}^3\left(\frac{x'}{\epsilon}\right), \\
 f_\epsilon(x, t) &= \tilde{f}\left(\frac{x'}{\epsilon}, t\right), \quad g_\epsilon^2(x, t) = \tilde{g}^2\left(\frac{x'}{\epsilon}, t\right), \quad g_\epsilon^3(x, t) = \tilde{g}^3\left(\frac{x'}{\epsilon}, t\right),
 \end{aligned}$$

and  $F(t)$  defined by (A.11)<sub>5</sub>.

## A.2 Micropolar Heat Problem

To perform the asymptotic analysis, we first need to rescale the domain, that is, to write the problem on  $B$  instead of  $B_\epsilon$ . We introduce the change of variables  $y' = \frac{x'}{\epsilon}$  and obtain the following system of equations deduced from (A.8):

$$\begin{aligned}
\frac{\partial \tilde{V}^1(y', t)}{\partial t} - \frac{\mu}{\epsilon^2} \Delta_{y'} \tilde{V}^1(y', t) &= \frac{a}{\epsilon} \left( \frac{\partial \tilde{W}^{3,1}(y', t)}{\partial y_2} - \frac{\partial \tilde{W}^{2,1}(y', t)}{\partial y_3} \right) + \tilde{f}(y', t), \\
\frac{\partial \tilde{W}^{2,1}(y', t)}{\partial t} - \frac{\alpha}{\epsilon^2} \Delta_{y'} \tilde{W}^{2,1}(y', t) - \frac{\beta}{\epsilon^2} \frac{\partial}{\partial y_2} \left( \frac{\partial \tilde{W}^{2,1}(y', t)}{\partial y_2} + \frac{\partial \tilde{W}^{3,1}(y', t)}{\partial y_3} \right) &+ 2a \tilde{W}^{2,1}(y', t) \\
&= \frac{a}{\epsilon} \frac{\partial \tilde{V}^1(y', t)}{\partial y_3} + \tilde{g}^2(y', t), \\
\frac{\partial \tilde{W}^{3,1}(y', t)}{\partial t} - \frac{\alpha}{\epsilon^2} \Delta_{y'} \tilde{W}^{3,1}(y', t) - \frac{\beta}{\epsilon^2} \frac{\partial}{\partial y_3} \left( \frac{\partial \tilde{W}^{2,1}(y', t)}{\partial y_2} + \frac{\partial \tilde{W}^{3,1}(y', t)}{\partial y_3} \right) &+ 2a \tilde{W}^{3,1}(y', t) \\
&= -\frac{a}{\epsilon} \frac{\partial \tilde{V}^1(y', t)}{\partial y_2} + \tilde{g}^3(y', t),
\end{aligned} \tag{A.12}$$

where  $\tilde{V}^1(y', t) = V_\epsilon^1(\epsilon y', t)$ ,  $\tilde{W}^{2,1}(y', t) = W_\epsilon^{2,1}(\epsilon y', t)$ ,  $\tilde{W}^{3,1}(y', t) = W_\epsilon^{3,1}(\epsilon y', t)$ . The boundary and initial conditions are the following:

$$\begin{aligned}
\tilde{V}^1(y', t) \Big|_{\partial B} &= 0, \quad \tilde{W}^{2,1}(y', t) \Big|_{\partial B} = 0, \quad \tilde{W}^{3,1}(y', t) \Big|_{\partial B} = 0, \\
\tilde{V}_1(y', 0) &= \tilde{a}(y'), \quad \tilde{W}^{2,1}(y', 0) = \tilde{b}^2(y'), \quad \tilde{W}^{3,1}(y', 0) = \tilde{b}^3(y').
\end{aligned}$$

We rewrite the problem (A.12) as

$$\begin{aligned}
-\mu \Delta_{y'} \tilde{V}^1(y', t) &= a \epsilon \left( \frac{\partial \tilde{W}^{3,1}(y', t)}{\partial y_2} - \frac{\partial \tilde{W}^{2,1}(y', t)}{\partial y_3} \right) + \epsilon^2 \tilde{f}(y', t) - \epsilon^2 \frac{\partial \tilde{V}^1(y', t)}{\partial t}, \\
-\alpha \Delta_{y'} \tilde{W}^{2,1}(y', t) - \beta \frac{\partial}{\partial y_2} \left( \frac{\partial \tilde{W}^{2,1}(y', t)}{\partial y_2} + \frac{\partial \tilde{W}^{3,1}(y', t)}{\partial y_3} \right) &= a \epsilon \frac{\partial \tilde{V}^1(y', t)}{\partial y_3} \\
&+ \epsilon^2 \tilde{g}^2(y', t) - \epsilon^2 \frac{\partial \tilde{W}^{2,1}(y', t)}{\partial t} - 2a \epsilon^2 \tilde{W}^{2,1}(y', t), \\
-\alpha \Delta_{y'} \tilde{W}^{3,1}(y', t) - \beta \frac{\partial}{\partial y_3} \left( \frac{\partial \tilde{W}^{2,1}(y', t)}{\partial y_2} + \frac{\partial \tilde{W}^{3,1}(y', t)}{\partial y_3} \right) &= -a \epsilon \frac{\partial \tilde{V}^1(y', t)}{\partial y_2} \\
&+ \epsilon^2 \tilde{g}^3(y', t) - \epsilon^2 \frac{\partial \tilde{W}^{3,1}(y', t)}{\partial t} - 2a \epsilon^2 \tilde{W}^{3,1}(y', t).
\end{aligned} \tag{A.13}$$



Now, we construct the formal asymptotic expansion of the solution  $(\tilde{V}_{\epsilon,[2]}^1(y', t), \tilde{W}_{\epsilon,[2]}^{2,1}(y', t), \tilde{W}_{\epsilon,[2]}^{3,1}(y', t))$  in powers of small parameter  $\epsilon$  up to  $\epsilon^4$  in the following way:

$$\begin{aligned}\tilde{V}_{\epsilon,[2]}^1(y', t) &= \epsilon^2 \tilde{V}_0^1(y', t) + \epsilon^3 \tilde{V}_1^1(y', t) + \epsilon^4 \tilde{V}_2^1(y', t), \\ \tilde{W}_{\epsilon,[2]}^{2,1}(y', t) &= \epsilon^2 \tilde{W}_0^{2,1}(y', t) + \epsilon^3 \tilde{W}_1^{2,1}(y', t) + \epsilon^4 \tilde{W}_2^{2,1}(y', t), \\ \tilde{W}_{\epsilon,[2]}^{3,1}(y', t) &= \epsilon^2 \tilde{W}_0^{3,1}(y', t) + \epsilon^3 \tilde{W}_1^{3,1}(y', t) + \epsilon^4 \tilde{W}_2^{3,2}(y', t).\end{aligned}\tag{A.14}$$

Due to the small thickness of the pipe, it reasonable to assume that the functions  $\tilde{f}(y', t)$ ,  $\tilde{g}^2(y', t)$ ,  $\tilde{g}^3(y', t)$  are independent of the the cross-section variables  $y' = (y_2, y_3)$ . Consequently, we are going to be in position to explicitly compute both the zero-order approximation and the correctors.

### A.2.1 Zero-Order Approximation

Plugging (A.14) and (A.11)<sub>3</sub>–(A.11)<sub>4</sub> into the system (A.13) and collecting the terms by the same power of  $\epsilon$ , we get:

$$\begin{aligned}-\mu \Delta_{y'} \tilde{V}_0^1(y', t) &= \tilde{f}_0(t), \\ -\alpha \Delta_{y'} \tilde{W}_0^{2,1}(y', t) - \beta \frac{\partial}{\partial y_2} \left( \frac{\partial \tilde{W}_0^{2,1}(y', t)}{\partial y_2} + \frac{\partial \tilde{W}_0^{3,1}(y', t)}{\partial y_3} \right) &= \tilde{g}_0^2(t), \\ -\alpha \Delta_{y'} \tilde{W}_0^{3,1}(y', t) - \beta \frac{\partial}{\partial y_3} \left( \frac{\partial \tilde{W}_0^{2,1}(y', t)}{\partial y_2} + \frac{\partial \tilde{W}_0^{3,1}(y', t)}{\partial y_3} \right) &= \tilde{g}_0^3(t), \\ \tilde{V}_0^1(y', t)|_{\partial B} &= 0, \quad \tilde{W}_0^{2,1}(y', t)|_{\partial B} = 0, \quad \tilde{W}_0^{3,1}(y', t)|_{\partial B} = 0.\end{aligned}\tag{A.15}$$

Note that the problems for the velocity and microrotation are decoupled at this particular stage. The equation (A.15)<sub>1</sub> with the boundary condition (A.15)<sub>4,1</sub> can be solved by taking

$$\tilde{V}_0^1(y', t) = \frac{1}{\mu} \chi^0(y') \tilde{f}_0(t),$$

where  $\chi^0(y')$  denotes the solution of the auxiliary problem posed on  $B$ :

$$\begin{aligned}-\Delta_{y'} \chi^0(y') &= 1, \quad y' \in B, \\ \chi^0(y')|_{\partial B} &= 0.\end{aligned}\tag{A.16}$$

Since we assumed the pipe has a circular cross-section, namely

$$B = \{y' \in \mathbb{R}^2 : |y'| < R\}, \quad R > 0,\tag{A.17}$$

we can pass to polar coordinates  $(r, \theta)$  and compute  $\chi^0$  explicitly from (A.16):

$$\chi^0(y') = \frac{1}{4}(R^2 - |y'|^2).$$

The explicit expression for the zero-order velocity approximation  $\tilde{V}_0^1(y', t)$  now reads:

$$\tilde{V}_0^1(y', t) = \frac{1}{4\mu}(R^2 - |y'|^2)\tilde{f}_0(t). \quad (\text{A.18})$$

Similarly, it can be straightforwardly verified that the problem (A.15)<sub>2</sub>, (A.15)<sub>3</sub> with the boundary conditions (A.15)<sub>4,2</sub>, (A.15)<sub>4,3</sub> for microrotation will be satisfied for:

$$\begin{aligned} \tilde{W}_0^{2,1}(y', t) &= \frac{2}{2\alpha + \beta}\chi^0(y')\tilde{g}_0^2(t) = \frac{1}{2(2\alpha + \beta)}(R^2 - |y'|^2)\tilde{g}_0^2(t), \\ \tilde{W}_0^{3,1}(y', t) &= \frac{2}{2\alpha + \beta}\chi^0(y')\tilde{g}_0^3(t) = \frac{1}{2(2\alpha + \beta)}(R^2 - |y'|^2)\tilde{g}_0^3(t). \end{aligned} \quad (\text{A.19})$$

### A.2.2 First-Order Corrector

Now, we compute the first-order corrector  $(\tilde{V}_1^1(y', t), \tilde{W}_1^{2,1}(y', t), \tilde{W}_1^{3,1}(y', t))$ . Inserting (A.14) and (A.11)<sub>3</sub>–(A.11)<sub>4</sub> into the system of equations (A.13), after collecting the terms by the same power of  $\epsilon$ , we obtain

$$\begin{aligned} -\mu\Delta_{y'}\tilde{V}_1^1(y', t) &= a\left(\frac{\partial\tilde{W}_0^{3,1}(y', t)}{\partial y_2} - \frac{\partial\tilde{W}_0^{2,1}(y', t)}{\partial y_3}\right) + \tilde{f}_1(t), \\ -\alpha\Delta_{y'}\tilde{W}_1^{2,1}(y', t) - \beta\frac{\partial}{\partial y_2}\left(\frac{\partial\tilde{W}_1^{2,1}(y', t)}{\partial y_2} + \frac{\partial\tilde{W}_1^{3,1}(y', t)}{\partial y_3}\right) &= a\frac{\partial\tilde{V}_0^1(y', t)}{\partial y_3} + \tilde{g}_1^2(t), \\ -\alpha\Delta_{y'}\tilde{W}_1^{3,1}(y', t) - \beta\frac{\partial}{\partial y_3}\left(\frac{\partial\tilde{W}_1^{2,1}(y', t)}{\partial y_2} + \frac{\partial\tilde{W}_1^{3,1}(y', t)}{\partial y_3}\right) &= -a\frac{\partial\tilde{V}_0^1(y', t)}{\partial y_2} + \tilde{g}_1^3(t), \\ \tilde{V}_1^1(y', t)\Big|_{\partial B} &= 0, \quad \tilde{W}_1^{2,1}(y', t)\Big|_{\partial B} = 0, \quad \tilde{W}_1^{3,1}(y', t)\Big|_{\partial B} = 0. \end{aligned} \quad (\text{A.20})$$

The system is not decoupled anymore, so the effects of the microstructure on the fluid velocity will be present. Using the expressions (A.19) for the microrotation zero-order approximation  $(\tilde{W}_{2,1}^0(y', t), \tilde{W}_{3,1}^0(y', t))$ , we get:

$$\begin{aligned} \mu\Delta_{y'}\tilde{V}_1^1(y', t) &= a\left(\frac{\tilde{g}_0^3(t)}{2\alpha + \beta}y_2 - \frac{\tilde{g}_0^2(t)}{2\alpha + \beta}y_3\right) - \tilde{f}_1(t), \\ \tilde{V}_1^1(y', t)\Big|_{\partial B} &= 0. \end{aligned}$$

Let us introduce  $\chi^i(y')$ ,  $i = 1, 2$  as the solutions of the following problems:

$$\begin{aligned} \Delta_{y'}\chi^i(y') &= y_{i+1}, \quad y' \in B, \\ \chi^i(y')\Big|_{\partial B} &= 0. \end{aligned}$$

Taking into account (A.17), and passing to the polar coordinates easily gives

$$\chi^1(y') = \frac{1}{8}(|y'|^2 - R^2)y_2, \quad \chi^2(y') = \frac{1}{8}(|y'|^2 - R^2)y_3.$$

We seek for the solution of the system (A.20) in the form

$$\tilde{V}_1^1(y', t) = \frac{1}{\mu} \left( \frac{a\tilde{g}_0^3(t)}{2\alpha + \beta} \chi^1(y') - \frac{a\tilde{g}_0^0(3)}{2\alpha + \beta} \chi^2(y') + \chi^0(y') \tilde{f}_1(t) \right),$$

leading to

$$\tilde{V}_1^1(y', t) = \frac{1}{8\mu} (|y'|^2 - R^2) \left( \frac{a\tilde{g}_0^3(t)}{2\alpha + \beta} y_2 - \frac{a\tilde{g}_0^3(t)}{2\alpha + \beta} y_3 - 2\tilde{f}_1(t) \right). \quad (\text{A.21})$$

Now we compute the corrector for the microrotation. Plugging the expression (A.18) for  $\tilde{V}_0^1(y', t)$  into (A.20)<sub>2</sub>–(A.20)<sub>3</sub> yields:

$$\begin{aligned} \alpha \Delta_{y'} \tilde{W}_1^{2,1}(y', t) + \beta \frac{\partial}{\partial y_2} \left( \frac{\partial \tilde{W}_1^{2,1}(y', t)}{\partial y_2} + \frac{\partial \tilde{W}_1^{3,1}(y', t)}{\partial y_3} \right) &= \frac{a\tilde{f}_0(t)}{2\mu} y_3 - \tilde{g}_1^2(t), \\ \alpha \Delta_{y'} \tilde{W}_1^{3,1}(y', t) + \beta \frac{\partial}{\partial y_3} \left( \frac{\partial \tilde{W}_1^{2,1}(y', t)}{\partial y_2} + \frac{\partial \tilde{W}_1^{3,1}(y', t)}{\partial y_3} \right) &= -\frac{a\tilde{f}_0(t)}{2\mu} y_2 - \tilde{g}_1^3(t), \\ \tilde{W}_1^{2,1}(y', t)|_{\partial B} &= 0, \quad \tilde{W}_1^{3,1}(y', t)|_{\partial B} = 0. \end{aligned}$$

Similarly as for  $\tilde{V}_1^1(y', t)$ , we obtain explicit expression for  $(\tilde{W}_1^{2,1}(y', t), \tilde{W}_1^{3,1}(y', t))$ , namely:

$$\begin{aligned} \tilde{W}_1^{2,1}(y', t) &= (|y'|^2 - R^2) \left( y_3 \frac{a}{16\mu\alpha} \tilde{f}_0(t) - \frac{1}{2(2\alpha + \beta)} \tilde{g}_1^2(t) \right), \\ \tilde{W}_1^{3,1}(y', t) &= (|y'|^2 - R^2) \left( -y_2 \frac{a}{16\mu\alpha} \tilde{f}_0(t) - \frac{1}{2(2\alpha + \beta)} \tilde{g}_1^3(t) \right). \end{aligned} \quad (\text{A.22})$$

### A.2.3 Second–Order Corrector

To capture the effects of the time derivative as well, we have to look for the second–order corrector. Substituting (A.14) and (A.11)<sub>3</sub>–(A.11)<sub>4</sub> into the system (A.13) and collecting the terms by the same power of  $\epsilon$  yields:

$$\begin{aligned} -\mu \Delta_{y'} \tilde{V}_2^1(y', t) &= a \left( \frac{\partial \tilde{W}_1^{3,1}(y', t)}{\partial y_2} - \frac{\partial \tilde{W}_1^{2,1}(y', t)}{\partial y_3} \right) + \tilde{f}_2(t) - \frac{\partial \tilde{V}_0^1(y', t)}{\partial t}, \\ &- \alpha \Delta_{y'} \tilde{W}_2^{2,1}(y', t) - \beta \frac{\partial}{\partial y_2} \left( \frac{\partial \tilde{W}_2^{2,1}(y', t)}{\partial y_2} + \frac{\partial \tilde{W}_2^{3,1}(y', t)}{\partial y_3} \right) \\ &= a \frac{\partial \tilde{V}_1^1(y', t)}{\partial y_3} + \tilde{g}_2^2(t) - \frac{\partial \tilde{W}_0^{2,1}(y', t)}{\partial t} - 2a \tilde{W}_0^{2,1}(y', t), \\ &- \alpha \Delta_{y'} \tilde{W}_2^{3,1}(y', t) - \beta \frac{\partial}{\partial y_3} \left( \frac{\partial \tilde{W}_2^{2,1}(y', t)}{\partial y_2} + \frac{\partial \tilde{W}_2^{3,1}(y', t)}{\partial y_3} \right) \\ &= -a \frac{\partial \tilde{V}_1^1(y', t)}{\partial y_2} + \tilde{g}_2^3(t) - \frac{\partial \tilde{W}_0^{3,1}(y', t)}{\partial t} - 2a \tilde{W}_0^{3,1}(y', t), \\ \tilde{V}_2^1(y', t)|_{\partial B} &= 0, \quad \tilde{W}_2^{2,1}(y', t)|_{\partial B} = 0, \quad \tilde{W}_2^{3,1}(y', t)|_{\partial B} = 0. \end{aligned} \quad (\text{A.23})$$

Taking into account (A.18) and (A.22), we get the following problem for  $\tilde{V}_2^1(y', t)$ :

$$\begin{aligned} -\mu\Delta_{y'}\tilde{V}_2^1(y', t) &= a\left(-\frac{a\tilde{f}_0(t)}{4\mu\alpha}\left(y_2^2 + y_3^2 - \frac{R^2}{2}\right) - \frac{\tilde{g}_1^3(t)}{2\alpha + \beta}y_2 - \frac{\tilde{g}_1^2(t)}{2\alpha + \beta}y_3\right) \\ &\quad + \tilde{f}_2(t) - (R^2 - y_2^2 - y_3^2)\frac{1}{4\mu}\frac{d}{dt}\tilde{f}_0(t), \\ \tilde{V}_2^1(y', t)\Big|_{\partial B} &= 0. \end{aligned}$$

We rewrite

$$\begin{aligned} -\mu\Delta_{y'}\tilde{V}_2^1(y', t) &= \frac{-a^2\tilde{f}_0(t) + \alpha\frac{d}{dt}\tilde{f}_0(t)}{4\mu\alpha}(y_2^2 + y_3^2) - \frac{a\tilde{g}_1^3(t)}{2\alpha + \beta}y_2 - \frac{a\tilde{g}_1^2(t)}{2\alpha + \beta}y_3 \\ &\quad + \tilde{f}_2(t) + \frac{(a^2\tilde{f}_0(t) - 2\alpha\frac{d}{dt}\tilde{f}_0(t))R^2}{8\mu\alpha}, \\ \tilde{V}_2^1(y', t)\Big|_{\partial B} &= 0, \end{aligned} \tag{A.24}$$

and introduce  $\chi^3(y')$  as the solution of the following problem:

$$\begin{aligned} \Delta_{y'}\chi^3(y') &= y_2^2 + y_3^2, \quad y' \in B, \\ \chi^3(y')\Big|_{\partial B} &= 0. \end{aligned}$$

Passing to the polar coordinates provides

$$\chi^3(y') = \frac{1}{16}(|y'|^4 - R^4).$$

We seek for the solution of (A.24) in the form

$$\begin{aligned} \tilde{V}_2^1(y', t) &= -\frac{1}{\mu}\frac{-a^2\tilde{f}_0(t) + \alpha\frac{d}{dt}\tilde{f}_0(t)}{4\mu\alpha}\chi^3(y') + \frac{1}{\mu}\frac{a\tilde{g}_1^3(t)}{2\alpha + \beta}\chi^1(y') \\ &\quad + \frac{1}{\mu}\frac{a\tilde{g}_1^2(t)}{2\alpha + \beta}\chi^2(y') + \frac{1}{\mu}\chi^0(y')\tilde{f}_2(t) + \frac{R^2}{\mu}\frac{a^2\tilde{f}_0(t) - 2\alpha\frac{d}{dt}\tilde{f}_0(t)}{8\mu\alpha}\chi^0(y'), \end{aligned}$$

implying

$$\begin{aligned} \tilde{V}_2^1(y', t) &= \frac{a^2\tilde{f}_0(t) - \alpha\frac{d}{dt}\tilde{f}_0(t)}{64\mu^2\alpha}(|y'|^4 - R^4) \\ &\quad + \left(\frac{a\tilde{g}_1^3(t)}{8\mu(2\alpha + \beta)}y_2 + \frac{a\tilde{g}_1^2(t)}{8\mu(2\alpha + \beta)}y_3\right)(|y'|^2 - R^2) \\ &\quad + \left(\frac{\tilde{f}_2(t)}{4\mu} + \frac{(a^2\tilde{f}_0(t) - 2\alpha\frac{d}{dt}\tilde{f}_0(t))R^2}{32\mu^2\alpha}\right)(R^2 - |y'|^2). \end{aligned} \tag{A.25}$$

Plugging (A.19) and (A.21) into the equations (A.23)<sub>2</sub> and (A.23)<sub>3</sub>, we get the following system for the second-order microrotation corrector ( $\tilde{W}_2^{2,1}(y', t), \tilde{W}_2^{3,1}(y', t)$ ):

$$\begin{aligned}
 & -\alpha \Delta_{y'} \tilde{W}_2^{2,1}(y', t) - \beta \frac{\partial}{\partial y_2} \left( \frac{\partial \tilde{W}_2^{2,1}(y', t)}{\partial y_2} + \frac{\partial \tilde{W}_2^{3,1}(y', t)}{\partial y_3} \right) \\
 = & a \left( -\frac{a \tilde{g}_0^2(t)}{8\mu(2\alpha + \beta)} (y_2^2 + 3y_3^2) + \frac{a \tilde{g}_0^3(t)}{4\mu(2\alpha + \beta)} y_2 y_3 + \frac{\tilde{f}_1(t)}{2\mu} y_3 + \frac{a R^2 \tilde{g}_0^2(t)}{8\mu(2\alpha + \beta)} \right) + \tilde{g}_2^2(t) \\
 & + \frac{1}{2(2\alpha + \beta)} (y_2^2 + y_3^2 - R^2) \frac{d}{dt} \tilde{g}_0^2(t) + \frac{a}{2\alpha + \beta} (y_2^2 + y_3^2 - R^2) \tilde{g}_0^2(t), \\
 & -\alpha \Delta_{y'} \tilde{W}_2^{3,1}(y', t) - \beta \frac{\partial}{\partial y_3} \left( \frac{\partial \tilde{W}_2^{2,1}(y', t)}{\partial y_2} + \frac{\partial \tilde{W}_2^{3,1}(y', t)}{\partial y_3} \right) \\
 = & a \left( -\frac{a \tilde{g}_0^3(t)}{8\mu(2\alpha + \beta)} (3y_2^2 + y_3^2) + \frac{a \tilde{g}_0^2(t)}{4\mu(2\alpha + \beta)} y_2 y_3 + \frac{\tilde{f}_1(t)}{2\mu} y_2 + \frac{a R^2 \tilde{g}_0^3(t)}{8\mu(2\alpha + \beta)} \right) \\
 & + \tilde{g}_2^3(t) + \frac{1}{2(2\alpha + \beta)} (y_2^2 + y_3^2 - R^2) \frac{d}{dt} \tilde{g}_0^3(t) + \frac{a}{2\alpha + \beta} (y_2^2 + y_3^2 - R^2) \tilde{g}_0^3(t), \\
 & \tilde{W}_2^{2,1}(y', t) \Big|_{\partial B} = 0, \quad \tilde{W}_2^{3,1}(y', t) \Big|_{\partial B} = 0.
 \end{aligned}$$

After rewriting, we obtain

$$\begin{aligned}
 & -\alpha \Delta_{y'} \tilde{W}_2^{2,1}(y', t) - \beta \frac{\partial}{\partial y_2} \left( \frac{\partial \tilde{W}_2^{2,1}(y', t)}{\partial y_2} + \frac{\partial \tilde{W}_2^{3,1}(y', t)}{\partial y_3} \right) \\
 = & \frac{-a^2 \tilde{g}_0^2(t) + 4\mu \frac{d}{dt} \tilde{g}_0^2(t) + 8a\mu \tilde{g}_0^2(t)}{8\mu(2\alpha + \beta)} y_2^2 \\
 + & \frac{-3a^2 \tilde{g}_0^2(t) + 4\mu \frac{d}{dt} \tilde{g}_0^2(t) + 8a\mu \tilde{g}_0^2(t)}{8\mu(2\alpha + \beta)} y_3^2 + \frac{a^2 \tilde{g}_0^3(t)}{4\mu(2\alpha + \beta)} y_2 y_3 + \frac{a \tilde{f}_1(t)}{2\mu} y_3 \\
 + & \frac{a^2 R^2 \tilde{g}_0^2(t) + 8\mu(2\alpha + \beta) \tilde{g}_2^2(t) - 4R^2 \mu \frac{d}{dt} \tilde{g}_0^2(t) - 8a\mu R^2 \tilde{g}_0^2(t)}{8\mu(2\alpha + \beta)}, \\
 & -\alpha \Delta_{y'} \tilde{W}_2^{3,1}(y', t) - \beta \frac{\partial}{\partial y_3} \left( \frac{\partial \tilde{W}_2^{2,1}(y', t)}{\partial y_2} + \frac{\partial \tilde{W}_2^{3,1}(y', t)}{\partial y_3} \right) \\
 = & \frac{-3a^2 \tilde{g}_0^3(t) + 4\mu \frac{d}{dt} \tilde{g}_0^3(t) + 8a\mu \tilde{g}_0^3(t)}{8\mu(2\alpha + \beta)} y_2^2 \\
 + & \frac{-a^2 \tilde{g}_0^3(t) + 4\mu \frac{d}{dt} \tilde{g}_0^3(t) + 8a\mu \tilde{g}_0^3(t)}{8\mu(2\alpha + \beta)} y_3^2 + \frac{a^2 \tilde{g}_0^2(t)}{4\mu(2\alpha + \beta)} y_2 y_3 + \frac{a \tilde{f}_1(t)}{2\mu} y_2 \\
 + & \frac{a^2 R^2 \tilde{g}_0^3(t) + 8\mu(2\alpha + \beta) \tilde{g}_2^3(t) - 4R^2 \mu \frac{d}{dt} \tilde{g}_0^3(t) - 8a\mu R^2 \tilde{g}_0^3(t)}{8\mu(2\alpha + \beta)}, \\
 & \tilde{W}_2^{2,1}(y', t) \Big|_{\partial B} = 0, \quad \tilde{W}_2^{3,1}(y', t) \Big|_{\partial B} = 0.
 \end{aligned}$$

Tedious but straightforward calculation gives:

$$\begin{aligned}
 \tilde{W}_2^{2,1}(y', t) &= (|y'|^2 - R^2) \left( C^1 y_2^2 + C^2 y_2 y_3 + C^3 y_3^2 + C^4 y_2 + C^5 y_3 + C^6 \right), \\
 \tilde{W}_2^{3,1}(y', t) &= (|y'|^2 - R^2) \left( C^7 y_2^2 + C^8 y_2 y_3 + C^9 y_3^2 + C^{10} y_2 + C^{11} y_3 + C^{12} \right),
 \end{aligned} \tag{A.26}$$

where

$$\begin{aligned}
C^1 &= \frac{(2\alpha - \frac{12\beta^2}{12\alpha+6\beta})C^3 + A - \frac{3\beta H}{12\alpha+6\beta}}{-14\alpha - 12\beta + \frac{12\beta^2}{12\alpha+6\beta}}, \quad C^2 = \frac{-4\beta(C^7 + C^9) - C}{12\alpha + 6\beta}, \\
C^3 &= \frac{(B - \frac{3\beta H}{12\alpha+6\beta})(-14\alpha - 12\beta + \frac{12\beta^2}{12\alpha+6\beta}) - (-2\alpha - 2\beta + \frac{12\beta^2}{12\alpha+6\beta})(A - \frac{3\beta H}{12\alpha+6\beta})}{(-2\alpha - 2\beta + \frac{12\beta^2}{12\alpha+6\beta})(2\alpha - \frac{12\beta^2}{12\alpha+6\beta}) + (-14\alpha - 2\beta + \frac{12\beta^2}{12\alpha+6\beta})^2}, \quad C^4 = 0, \\
C^5 &= \frac{I + (8\alpha + 2\beta)C^{10}}{-2\beta}, \quad C^6 = \frac{2\alpha R^2(C^1 + C^3) + 2\beta R^2 C^1 + \beta R^2 C^8 - E}{4\alpha + 2\beta}, \\
C^7 &= \frac{F - \frac{3\beta C}{12\alpha+6\beta} + (2\alpha + 2\beta - \frac{12\beta^2}{12\alpha+6\beta})C^9}{-14\alpha - 2\beta + \frac{12\beta^2}{12\alpha+6\beta}}, \quad C^8 = \frac{-4\beta(C^1 + C^3) - H}{12\alpha + 6\beta}, \\
C^9 &= \frac{(G - \frac{3\beta C}{12\alpha+6\beta})(-14\alpha - 2\beta + \frac{12\beta^2}{12\alpha+6\beta}) + (2\alpha - \frac{12\beta^2}{12\alpha+6\beta})(F - \frac{3\beta C}{12\alpha+6\beta})}{C_9^*}, \\
C^{10} &= \frac{2D\beta - I(8\alpha + 2\beta)}{(8\alpha + 2\beta)^2 - 4\beta^2}, \quad C^{11} = 0, \quad C^{12} = \frac{2\alpha R^2(C^7 + C^9) + 2\beta R^2 C^9 + \beta R^2 C^2 - J}{4\alpha + 2\beta},
\end{aligned} \tag{A.27}$$

where

$$\begin{aligned}
A &= \frac{-a^2 \tilde{g}_0^2(t) + 4\mu \frac{d}{dt} \tilde{g}_0^2(t) + 8a\mu \tilde{g}_0^2(t)}{8\mu(2\alpha + \beta)}, \quad B = \frac{-3a^2 \tilde{g}_0^2(t) + 4\mu \frac{d}{dt} \tilde{g}_0^2(t) + 8a\mu \tilde{g}_0^2(t)}{8\mu(2\alpha + \beta)}, \\
C &= \frac{a^2 \tilde{g}_0^3(t)}{4\mu(2\alpha + \beta)}, \quad D = \frac{a \tilde{f}_1(t)}{2\mu}, \\
E &= \frac{a^2 R^2 \tilde{g}_0^2(t) + 8\mu(2\alpha + \beta) \tilde{g}_2^2(t) - 4R^2 \mu \frac{d}{dt} \tilde{g}_0^2(t) - 8a\mu R^2 \tilde{g}_0^2(t)}{8\mu(2\alpha + \beta)}, \\
F &= \frac{-3a^2 \tilde{g}_0^3(t) + 4\mu \frac{d}{dt} \tilde{g}_0^3(t) + 8a\mu \tilde{g}_0^3(t)}{8\mu(2\alpha + \beta)}, \quad G = \frac{-a^2 \tilde{g}_0^3(t) + 4\mu \frac{d}{dt} \tilde{g}_3^0(t) + 8a\mu \tilde{g}_0^3(t)}{8\mu(2\alpha + \beta)}, \\
H &= \frac{a^2 \tilde{g}_0^2(t)}{4\mu(2\alpha + \beta)}, \quad I = \frac{a \tilde{f}_1(t)}{2\mu}, \\
J &= \frac{a^2 R^2 \tilde{g}_0^3(t) + 8\mu(2\alpha + \beta) \tilde{g}_2^3(t) - 4R^2 \mu \frac{d}{dt} \tilde{g}_0^3(t) - 8a\mu R^2 \tilde{g}_0^3(t)}{8\mu(2\alpha + \beta)},
\end{aligned}$$

and

$$\begin{aligned}
C_9^* &= \left( -2\alpha + \frac{12\beta^2}{12\alpha + 6\beta} \right) \left( 2\alpha + 2\beta - \frac{12\beta^2}{12\alpha + 6\beta} \right) \\
&\quad + \left( -14\alpha - 12\beta + \frac{12\beta^2}{12\alpha + 6\beta} \right) \left( -14\alpha - 2\beta + \frac{12\beta^2}{12\alpha + 6\beta} \right).
\end{aligned}$$

### A.3 Micropolar Inverse Problem

Now, we turn our attention to micropolar inverse problem (A.9). First, we notice that

$$\begin{aligned}
 H(t) &= \sum_{j=0}^2 \epsilon^{j+4} F_j(t) - \sum_{j=0}^2 \int_{B^\epsilon} \epsilon^{j+2} \tilde{V}_j^1\left(\frac{x'}{\epsilon}, t\right) dx' \\
 &= \sum_{j=0}^2 \epsilon^{j+4} F_j(t) - \sum_{j=0}^2 \int_B \epsilon^{j+4} \tilde{V}_j^1(y', t) dy' \\
 &= \sum_{j=0}^2 \epsilon^{j+4} H_j(t).
 \end{aligned}$$

Denoting

$$H_j(t) = F_j(t) - \int_B \tilde{V}_j^1(y', t) dy', \quad j = 0, 1, 2,$$

we have the compatibility condition (due to (A.10))

$$H_j(0) = 0, \quad j = 0, 1, 2,$$

or

$$F_j(0) = \int_B \tilde{a}_j(y') dy', \quad j = 0, 1, 2.$$

Performing the change of variables  $y' = \frac{x'}{\epsilon}$  and putting  $q(t) = \frac{1}{\epsilon^2} s(t)$ , from (A.9) we deduce

$$\begin{aligned}
 -\mu \Delta_{y'} \tilde{V}^2(y', t) &= a\epsilon \left( \frac{\partial \tilde{W}^{3,2}(y', t)}{\partial y_2} - \frac{\partial \tilde{W}^{2,2}(y', t)}{\partial y_3} \right) + s(t) - \epsilon^2 \frac{\partial \tilde{V}^2(y', t)}{\partial t}, \\
 -\alpha \Delta_{y'} \tilde{W}^{2,2}(y', t) - \beta \frac{\partial}{\partial y_2} \left( \frac{\partial \tilde{W}^{2,2}(y', t)}{\partial y_2} + \frac{\partial \tilde{W}^{3,2}(y', t)}{\partial y_3} \right) \\
 &= a\epsilon \frac{\partial \tilde{V}^2(y', t)}{\partial y_3} - \epsilon^2 \frac{\partial \tilde{W}^{2,2}(y', t)}{\partial t} - 2a\epsilon^2 \tilde{W}^{2,2}(y', t), \\
 -\alpha \Delta_{y'} \tilde{W}^{3,2}(y', t) - \beta \frac{\partial}{\partial y_3} \left( \frac{\partial \tilde{W}^{2,2}(y', t)}{\partial y_2} + \frac{\partial \tilde{W}^{3,2}(y', t)}{\partial y_3} \right) \\
 &= -a\epsilon \frac{\partial \tilde{V}^2(y', t)}{\partial y_2} - \epsilon^2 \frac{\partial \tilde{W}^{3,2}(y', t)}{\partial t} - 2a\epsilon^2 \tilde{W}^{3,2}(y', t), \\
 \tilde{V}^2(y', t)|_{\partial B} &= 0, \quad \tilde{W}^{2,2}(y', t)|_{\partial B} = 0, \quad \tilde{W}^{3,2}(y', t)|_{\partial B} = 0, \\
 \tilde{V}^2(y', 0) &= 0, \quad \tilde{W}^{2,2}(y', 0) = 0, \quad \tilde{W}^{3,2}(y', 0) = 0, \\
 \int_B \tilde{V}^2(y', t) dy' &= \frac{1}{\epsilon^2} H(t),
 \end{aligned} \tag{A.28}$$

where  $\tilde{V}^2(y', t) = V_\epsilon^2(\epsilon y', t)$ ,  $\tilde{W}^{2,2}(y', t) = W_\epsilon^{2,2}(\epsilon y', t)$ ,  $\tilde{W}^{3,2}(y', t) = W_\epsilon^{3,2}(\epsilon y', t)$ . In the sequel, we look for the asymptotic approximation in the form

$$\begin{aligned}\tilde{V}_{\epsilon,[2]}^2(y', t) &= \epsilon^2 \tilde{V}_0^2(y', t) + \epsilon^3 \tilde{V}_1^2(y', t) + \epsilon^4 \tilde{V}_2^2(y', t), \\ \tilde{W}_{\epsilon,[2]}^{2,2}(y', t) &= \epsilon^2 \tilde{W}_0^{2,2}(y', t) + \epsilon^3 \tilde{W}_1^{2,2}(y', t) + \epsilon^4 \tilde{W}_2^{2,2}(y', t), \\ \tilde{W}_{\epsilon,[2]}^{3,2}(y', t) &= \epsilon^2 \tilde{W}_0^{3,2}(y', t) + \epsilon^3 \tilde{W}_1^{3,2}(y', t) + \epsilon^4 \tilde{W}_2^{3,2}(y', t), \\ s_{\epsilon,[2]}(t) &= \epsilon^2 s_0(t) + \epsilon^3 s_1(t) + \epsilon^4 s_2(t).\end{aligned}$$

### A.3.1 Zero-Order Approximation

For the zero-order approximation  $(\tilde{V}_0^2(y', t), \tilde{W}_0^{2,2}(y', t), \tilde{W}_0^{3,2}(y', t), s_0(t))$ , we obtain the following problem:

$$\begin{aligned}-\mu \Delta_{y'} \tilde{V}_0^2(y', t) &= s_0(t), \\ -\alpha \Delta_{y'} \tilde{W}_0^{2,2}(y', t) - \beta \frac{\partial}{\partial y_2} \left( \frac{\partial \tilde{W}_0^{2,2}(y', t)}{\partial y_2} + \frac{\partial \tilde{W}_0^{3,2}(y', t)}{\partial y_3} \right) &= 0, \\ -\alpha \Delta_{y'} \tilde{W}_0^{3,2}(y', t) - \beta \frac{\partial}{\partial y_3} \left( \frac{\partial \tilde{W}_0^{2,2}(y', t)}{\partial y_2} + \frac{\partial \tilde{W}_0^{3,2}(y', t)}{\partial y_3} \right) &= 0, \\ \tilde{V}_0^2(y', t)|_{\partial B} = 0, \quad \tilde{W}_0^{2,2}(y', t)|_{\partial B} = 0, \quad \tilde{W}_0^{3,2}(y', t)|_{\partial B} = 0, \\ \int_B \tilde{V}_0^2(y', t) dy' &= H_0(t),\end{aligned}\tag{A.29}$$

where  $H_0(t)$  is given by

$$H_0(t) = F_0(t) - \int_B \tilde{V}_0^1(y', t) dy' = F_0(t) - \frac{R^4 \pi}{8\mu} \tilde{f}_0(t).\tag{A.30}$$

The equation (A.29)<sub>1</sub> with the boundary condition (A.29)<sub>4,1</sub> and the flux rate (A.29)<sub>5</sub> can be solved by taking

$$\tilde{V}_0^2(y', t) = \frac{1}{4\mu} (R^2 - |y'|^2) s_0(t).\tag{A.31}$$

Here we choose  $s_0(t)$  to satisfy the flux condition:

$$s_0(t) = \kappa_0^{-1} H_0(t),$$

where

$$\kappa_0 = \int_B \frac{1}{4\mu} (R^2 - |y'|^2) = \frac{R^4 \pi}{8\mu} > 0.$$

We now look at the system (A.29)<sub>2</sub>, (A.29)<sub>3</sub>, (A.29)<sub>4,2</sub>, (A.29)<sub>4,3</sub> and observe it has the same structure as the system (A.15)<sub>2</sub>, (A.15)<sub>3</sub>, (A.15)<sub>4,2</sub>, (A.15)<sub>4,3</sub> for the zero-order approximation of the micropolar heat problem with  $(\tilde{g}_0^2(y', t), \tilde{g}_0^3(y', t)) \equiv (0, 0)$ . Thus, we conclude

$$(\tilde{W}_0^{2,2}(y', t), \tilde{W}_0^{3,2}(y', t)) \equiv (0, 0).\tag{A.32}$$



### A.3.2 First-Order Corrector

The first-order corrector  $(\tilde{V}_1^2(y', t), \tilde{W}_1^{2,2}(y', t), \tilde{W}_1^{3,2}(y', t), s_1(t))$  is given by the following problem:

$$\begin{aligned}
 -\mu\Delta_{y'}\tilde{V}_1^2(y', t) &= a\left(\frac{\partial\tilde{W}_0^{3,2}(y', t)}{\partial y_2} - \frac{\partial\tilde{W}_0^{2,2}(y', t)}{\partial y_3}\right) + s_1(t), \\
 -\alpha\Delta_{y'}\tilde{W}_1^{2,2}(y', t) - \beta\frac{\partial}{\partial y_2}\left(\frac{\partial\tilde{W}_1^{2,2}(y', t)}{\partial y_2} + \frac{\partial\tilde{W}_1^{3,2}(y', t)}{\partial y_3}\right) &= a\frac{\partial\tilde{V}_0^2(y', t)}{\partial y_3}, \\
 -\alpha\Delta_{y'}\tilde{W}_1^{3,2}(y', t) - \beta\frac{\partial}{\partial y_3}\left(\frac{\partial\tilde{W}_1^{2,2}(y', t)}{\partial y_2} + \frac{\partial\tilde{W}_1^{3,2}(y', t)}{\partial y_3}\right) &= -a\frac{\partial\tilde{V}_0^2(y', t)}{\partial y_2}, \\
 \tilde{V}_1^2(y', t)\Big|_{\partial B} = 0, \quad \tilde{W}_1^{2,2}(y', t)\Big|_{\partial B} = 0, \quad \tilde{W}_1^{3,2}(y', t)\Big|_{\partial B} = 0. \\
 \int_B \tilde{V}_1^2(y', t)dy' &= H_1(t),
 \end{aligned} \tag{A.33}$$

where  $H_1(t)$  is given by

$$H_1(t) = F_1(t) - \int_B \tilde{V}_1^1(y', t)dy' = F_1(t) - \frac{R^4\pi}{8\mu}\tilde{f}_1(t). \tag{A.34}$$

We notice that the system is not decoupled anymore. Inserting the expression for  $(\tilde{V}_0^2(y', t), \tilde{W}_0^{2,2}(y', t), \tilde{W}_0^{3,2}(y', t))$  given by (A.31) and (A.32), we obtain

$$\begin{aligned}
 -\mu\Delta_{y'}\tilde{V}_1^2(y', t) &= s_1(t), \\
 -\alpha\Delta_{y'}\tilde{W}_1^{2,2}(y', t) - \beta\frac{\partial}{\partial y_2}\left(\frac{\partial\tilde{W}_1^{2,2}(y', t)}{\partial y_2} + \frac{\partial\tilde{W}_1^{3,2}(y', t)}{\partial y_3}\right) &= -\frac{a}{2\mu}y_3s_0(t), \\
 -\alpha\Delta_{y'}\tilde{W}_1^{3,2}(y', t) - \beta\frac{\partial}{\partial y_3}\left(\frac{\partial\tilde{W}_1^{2,2}(y', t)}{\partial y_2} + \frac{\partial\tilde{W}_1^{3,2}(y', t)}{\partial y_3}\right) &= \frac{a}{2\mu}y_2s_0(t), \\
 \tilde{V}_1^2(y', t)\Big|_{\partial B} = 0, \quad \tilde{W}_1^{2,2}(y', t)\Big|_{\partial B} = 0, \quad \tilde{W}_1^{3,2}(y', t)\Big|_{\partial B} = 0. \\
 \int_B \tilde{V}_1^2(y', t)dy' &= H_1(t).
 \end{aligned} \tag{A.35}$$

As above, the equation (A.33)<sub>1</sub> with the boundary condition (A.33)<sub>4,1</sub> and flux rate (A.33)<sub>5</sub> can be solved by taking:

$$\tilde{V}_1^2(y', t) = \frac{1}{4\mu}(R^2 - |y'|^2)s_1(t), \tag{A.36}$$

with  $s_1(t)$  obeying the flux condition:

$$s^1(t) = \kappa_1^{-1}H_1(t),$$

with

$$\kappa_1 = \int_B \frac{1}{4\mu}(R^2 - |y'|^2) = \frac{R^4\pi}{8\mu} > 0.$$

One can easily verify that the system  $(A.35)_2, (A.35)_3$  for the microrotation corrector with the boundary conditions  $(A.35)_{4,2}, (A.35)_{4,3}$  is satisfied for:

$$\begin{aligned}\tilde{W}_1^{2,2}(y', t) &= (|y'|^2 - R^2) \frac{aH_0(t)}{16\mu\alpha\kappa_0} y_3, \\ \tilde{W}_1^{3,2}(y', t) &= (|y'|^2 - R^2) \frac{-aH_0(t)}{16\mu\alpha\kappa_0} y_2.\end{aligned}\tag{A.37}$$

### A.3.3 Second–Order Corrector

To conclude the analysis for the micropolar inverse problem (A.28), we identify the terms by the same power of  $\epsilon$  to get the system for the second–order corrector  $(\tilde{V}_2^2(y', t), \tilde{W}_2^{2,2}(y', t), \tilde{W}_2^{3,2}(y', t), s_2(t))$ . It reads:

$$\begin{aligned}-\mu\Delta_{y'}\tilde{V}_2^2(y', t) &= a\left(\frac{\partial\tilde{W}_1^{3,2}(y', t)}{\partial y_2} - \frac{\partial\tilde{W}_1^{2,2}(y', t)}{\partial y_3}\right) + s_2(t) - \frac{\partial\tilde{V}_0^2(y', t)}{\partial t}, \\ &- \alpha\Delta_{y'}\tilde{W}_2^{2,2}(y', t) - \beta\frac{\partial}{\partial y_2}\left(\frac{\partial\tilde{W}_2^{2,2}(y', t)}{\partial y_2} + \frac{\partial\tilde{W}_2^{3,2}(y', t)}{\partial y_3}\right) \\ &= a\frac{\partial\tilde{V}_1^2(y', t)}{\partial y_3} - \frac{\partial\tilde{W}_0^{2,2}(y', t)}{\partial t} - 2a\tilde{W}_0^{2,2}(y', t), \\ &- \alpha\Delta_{y'}\tilde{W}_2^{3,2}(y', t) - \beta\frac{\partial}{\partial y_3}\left(\frac{\partial\tilde{W}_2^{3,2}(y', t)}{\partial y_2} + \frac{\partial\tilde{W}_2^{2,2}(y', t)}{\partial y_3}\right) \\ &= -a\frac{\partial\tilde{V}_1^2(y', t)}{\partial y_2} - \frac{\partial\tilde{W}_0^{3,2}(y', t)}{\partial t} - 2a\tilde{W}_0^{3,2}(y', t), \\ \tilde{V}_2^2(y', t)\Big|_{\partial B} &= 0, \quad \tilde{W}_2^{2,2}(y', t)\Big|_{\partial B} = 0, \quad \tilde{W}_2^{3,2}(y', t)\Big|_{\partial B} = 0, \\ \int_B \tilde{V}_2^2(y', t) dy' &= H_2(t),\end{aligned}\tag{A.38}$$

where  $H_2(t)$  is given by

$$\begin{aligned}H_2(t) &= F_2(t) - \int_B \tilde{V}_2^1(y', t) dy' = F_2(t) - \frac{\pi R^6 \alpha \frac{d}{dt} \tilde{f}_0(t) - \pi R^6 a^2 \tilde{f}_0(t)}{96\mu^2 \alpha} \\ &\quad - \frac{8\pi\mu\alpha R^4 \tilde{f}_2(t) + \pi R^6 (a^2 \tilde{f}_0(t) - 2\alpha \frac{d}{dt} \tilde{f}_0(t))}{264\mu^3 \alpha}.\end{aligned}\tag{A.39}$$

Employing the expressions for the zero-order approximation given by (A.31) and (A.32) and for the first-order corrector given by (A.36) and (A.37), from (A.38) we get the following:

$$\begin{aligned}
 -\mu\Delta_{y'}\tilde{V}_2^2(y',t) &= \left(-\frac{a^2H_0(t)}{4\mu\alpha\kappa_0} + \frac{\frac{d}{dt}H_0(t)}{4\mu\kappa_0}\right)(y_2^2 + y_3^2) + s_2(t) + \frac{R^2a^2H_0(t) - 2\alpha R^2H_0(t)}{8\mu\alpha\kappa_0}, \\
 -\alpha\Delta_{y'}\tilde{W}_2^{2,2}(y',t) - \beta\frac{\partial}{\partial y_2}\left(\frac{\partial\tilde{W}_2^{2,2}(y',t)}{\partial y_2} + \frac{\partial\tilde{W}_2^{3,2}(y',t)}{\partial y_3}\right) &= \frac{-aH_1(t)}{2\mu\kappa_1}y_3, \\
 -\alpha\Delta_{y'}\tilde{W}_2^{3,2}(y',t) - \beta\frac{\partial}{\partial y_3}\left(\frac{\partial\tilde{W}_2^{2,2}(y',t)}{\partial y_2} + \frac{\partial\tilde{W}_2^{3,2}(y',t)}{\partial y_3}\right) &= \frac{aH_1(t)}{2\mu\kappa_1}y_2, \\
 \tilde{V}_2^2(y',t)|_{\partial B} = 0, \quad \tilde{W}_2^{2,2}(y',t)|_{\partial B} = 0, \quad \tilde{W}_2^{3,2}(y',t)|_{\partial B} = 0, \\
 \int_B \tilde{V}_2^2(y',t)dy' &= H_2(t).
 \end{aligned}$$

We can now explicitly compute the velocity corrector  $\tilde{V}_2^2(y',t)$  as

$$\begin{aligned}
 \tilde{V}_2^2(y',t) &= -\frac{1}{16\mu}\left(-\frac{a^2H_0(t)}{4\mu\alpha\kappa_0} + \frac{\frac{d}{dt}H_0(t)}{4\mu\kappa_0}\right)(|y'|^4 - R^4) \\
 &\quad - \frac{1}{4\mu}\left(s_2(t) + \frac{R^2a^2H_0(t) - 2\alpha R^2H_0(t)}{8\mu\alpha\kappa_0}\right)(|y'|^2 - R^2),
 \end{aligned} \tag{A.40}$$

where we choose  $s_2(t)$  to satisfy the flux condition:

$$s_2(t) = \frac{H_2(t) + \frac{1}{16\mu}\left(-\frac{a^2H_0(t)}{4\mu\alpha\kappa_0} + \frac{\frac{d}{dt}H_0(t)}{4\mu\kappa_0}\right)\left(-\frac{2\pi R^6}{3}\right) + \frac{1}{4\mu}\frac{R^2a^2H_0(t) - 2\alpha R^2H_0(t)}{8\mu\alpha\kappa_0}\left(-\frac{R^4\pi}{2}\right)}{-\frac{1}{4\mu}\left(-\frac{R^4\pi}{2}\right)}.$$

Similarly, we can explicitly compute the corrector for the microrotation:

$$\begin{aligned}
 \tilde{W}_2^{2,2}(y',t) &= (|y'|^2 - R^2)\frac{aH_1(t)}{16\mu\alpha\kappa_1}y_3, \\
 \tilde{W}_2^{3,2}(y',t) &= (|y'|^2 - R^2)\frac{-aH_1(t)}{16\mu\alpha\kappa_1}y_2.
 \end{aligned} \tag{A.41}$$

## A.4 Asymptotic Approximation

The asymptotic approximation related to the micropolar heat problem (A.8) has the following form:

$$\begin{aligned}
 \tilde{V}_{\epsilon,[2]}^1(x',t) &= \epsilon^2\tilde{V}_0^1\left(\frac{x'}{\epsilon},t\right) + \epsilon^3\tilde{V}_1^1\left(\frac{x'}{\epsilon},t\right) + \epsilon^4\tilde{V}_2^1\left(\frac{x'}{\epsilon},t\right), \\
 \tilde{W}_{\epsilon,[2]}^{2,1}(x',t) &= \epsilon^2\tilde{W}_0^{2,1}\left(\frac{x'}{\epsilon},t\right) + \epsilon^3\tilde{W}_1^{2,1}\left(\frac{x'}{\epsilon},t\right) + \epsilon^4\tilde{W}_2^{2,1}\left(\frac{x'}{\epsilon},t\right), \\
 \tilde{W}_{\epsilon,[2]}^{3,1}(x',t) &= \epsilon^2\tilde{W}_0^{3,1}\left(\frac{x'}{\epsilon},t\right) + \epsilon^3\tilde{W}_1^{3,1}\left(\frac{x'}{\epsilon},t\right) + \epsilon^4\tilde{W}_2^{3,1}\left(\frac{x'}{\epsilon},t\right).
 \end{aligned}$$

Note we have calculated all the terms explicitly, i.e.  $(\tilde{V}_j^1(\frac{x'}{\epsilon}, t), \tilde{W}_j^{2,1}(\frac{x'}{\epsilon}, t), \tilde{W}_j^{3,1}(\frac{x'}{\epsilon}, t))$ ,  $j = 0, 1, 2$  are given by (A.18)-(A.19), (A.21), (A.22), (A.25) and (A.26)-(A.27).

For the micropolar inverse problem (A.9), we obtain the following:

$$\begin{aligned}\tilde{V}_{\epsilon,[2]}^2(x', t) &= \epsilon^2 \tilde{V}_0^2\left(\frac{x'}{\epsilon}, t\right) + \epsilon^3 \tilde{V}_1^2\left(\frac{x'}{\epsilon}, t\right) + \epsilon^4 \tilde{V}_2^2\left(\frac{x'}{\epsilon}, t\right), \\ \tilde{W}_{\epsilon,[2]}^{2,2}(x', t) &= \epsilon^2 \tilde{W}_0^{2,2}\left(\frac{x'}{\epsilon}, t\right) + \epsilon^3 \tilde{W}_1^{2,2}\left(\frac{x'}{\epsilon}, t\right) + \epsilon^4 \tilde{W}_2^{2,2}\left(\frac{x'}{\epsilon}, t\right), \\ \tilde{W}_{\epsilon,[2]}^{3,2}(x', t) &= \epsilon^2 \tilde{W}_0^{3,2}\left(\frac{x'}{\epsilon}, t\right) + \epsilon^3 \tilde{W}_1^{3,2}\left(\frac{x'}{\epsilon}, t\right) + \epsilon^4 \tilde{W}_2^{3,2}\left(\frac{x'}{\epsilon}, t\right), \\ s_{\epsilon,[2]}(t) &= \epsilon^2 s_0(t) + \epsilon^3 s_1(t) + \epsilon^4 s_2(t),\end{aligned}$$

where  $(\tilde{V}_j^2(\frac{x'}{\epsilon}, t), \tilde{W}_j^{2,2}(\frac{x'}{\epsilon}, t), \tilde{W}_j^{3,2}(\frac{x'}{\epsilon}, t), s_j(t))$ ,  $j = 0, 1, 2$  are given by the explicit formulae (A.31)-(A.32), (A.36)-(A.37) and (A.40)-(A.41).

Collecting the above results, we arrive at the asymptotic approximation  $(v_{\epsilon,[2]}(x', t), w_{\epsilon,[2]}^2(x', t), w_{\epsilon,[2]}^3(x', t), q_{\epsilon,[2]}(t))$  for the problem (A.5)–(A.7):

$$\begin{aligned}v_{\epsilon,[2]}(x', t) &= V_{\epsilon,[2]}^1(x', t) + V_{\epsilon,[2]}^2(x', t), \\ w_{\epsilon,[2]}^2(x', t) &= \tilde{W}_{\epsilon,[2]}^{2,1}(x', t) + \tilde{W}_{\epsilon,[2]}^{2,2}(x', t), \quad w_{\epsilon,[2]}^3(x', t) = \tilde{W}_{\epsilon,[2]}^{3,1}(x', t) + \tilde{W}_{\epsilon,[2]}^{3,2}(x', t), \\ q_{\epsilon,[2]}(t) &= \frac{1}{\epsilon^2} s_{\epsilon,[2]}(t).\end{aligned}$$

It should be noted that the above asymptotic approximation was computed to satisfy the equations (A.5), the boundary conditions (A.6)<sub>1</sub> and the flux condition (A.7). The initial conditions (A.6)<sub>2</sub> were not taken into account in the process due to the fact that the time derivative appears only in the system for the second-order corrector (namely, as the time derivative of the zero-order approximation for the velocity and microrotation which is a known function on the right-hand side). Thus, taking into account the initial conditions while computing the correctors would yield an over-determined system for the unknown terms in the asymptotic expansion. This essentially means that a boundary-layer-in-time phenomena appears, i.e. near  $t = 0$ , we have some influence of the initial conditions that cannot be captured by the regular expansion. We can fix that by introducing the appropriate boundary-layer correctors. Detailed analysis of the boundary layers together with the rigorous justification of the complete asymptotic expansion is presented in Chapter 3.

## A.5 Numerical Example

Finally, in this section, we aim to visually present the derived asymptotic solution for the problem (A.5)–(A.7). We take the following values for the viscosity constants (see e.g. [3], [23]):

$$\begin{aligned} \nu &= 2.9 \times 10^{-3}, \quad \nu_r = 2.32 \times 10^{-4}, \quad a = 2\nu_r = 4.64 \times 10^{-4}, \\ \mu &= \nu + \nu_r, \quad \alpha = c_a + c_d = 10^{-6}, \quad \beta = c_0 + c_d - c_a = 10^{-6}. \end{aligned}$$

The domain is circular with radius  $R = 10$ . Furthermore, all the visualizations are done for fixed time  $t = 10$  and given flow rates  $F_0(t) = t + 50$ ,  $F_1(t) = t^2$  and  $F_2(t) = t^3$ . The linear and angular momentum force functions are neglected, namely  $\tilde{f}_\epsilon(t) \equiv \tilde{g}_\epsilon^2(t) \equiv \tilde{g}_\epsilon^3(t) \equiv 0$ . Therefore, it follows that  $(\tilde{V}_{\epsilon,[2]}^1(x', t), \tilde{W}_{\epsilon,[2]}^{2,1}(x', t), \tilde{W}_{\epsilon,[2]}^{3,1}(x', t)) \equiv 0$  (see (A.18)–(A.19), (A.21), (A.22), (A.25) and (A.26)–(A.27)) and  $F^j(t) \equiv H^j(t)$ ,  $j = 0, 1, 2$  (see (A.30), (A.34) and (A.39)). As a result, the asymptotic solution reads:

$$\begin{aligned} v_{\epsilon,[2]}(x', t) &= \epsilon^2 \tilde{V}_0^2\left(\frac{x'}{\epsilon}, t\right) + \epsilon^3 \tilde{V}_1^2\left(\frac{x'}{\epsilon}, t\right) + \epsilon^4 \tilde{V}_2^2\left(\frac{x'}{\epsilon}, t\right), \\ w_{\epsilon,[2]}^2(x', t) &= \epsilon^2 \tilde{W}_0^{2,2}\left(\frac{x'}{\epsilon}, t\right) + \epsilon^3 \tilde{W}_1^{2,2}\left(\frac{x'}{\epsilon}, t\right) + \epsilon^4 \tilde{W}_{2,2}^2\left(\frac{x'}{\epsilon}, t\right), \\ w_{\epsilon,[2]}^3(x', t) &= \epsilon^2 \tilde{W}_0^{3,2}\left(\frac{x'}{\epsilon}, t\right) + \epsilon^3 \tilde{W}_1^{3,2}\left(\frac{x'}{\epsilon}, t\right) + \epsilon^4 \tilde{W}_2^{3,2}\left(\frac{x'}{\epsilon}, t\right), \end{aligned} \quad (\text{A.42})$$

where  $(\tilde{V}_j^2(\frac{x'}{\epsilon}, t), \tilde{W}_j^{2,2}(\frac{x'}{\epsilon}, t), \tilde{W}_j^{3,2}(\frac{x'}{\epsilon}, t))$ ,  $j = 0, 1, 2$  have been explicitly computed in (A.31)–(A.32), (A.36)–(A.37) and (A.40)–(A.41).

In Section A.5.1, we depict the second–order correctors for the velocity and microrotation (see Figs. A.2–A.3). The whole asymptotic approximation for the velocity and microrotation for  $\epsilon = 0.1$ , given by (A.42), is presented in Section A.5.2 (see Figs A.4–A.5). We omit the visualizations for the zero-order approximations and first-order correctors since they are of the classical Poiseuille form (for the velocity) and of the same form as the second order corrector for the microrotation.

### A.5.1 Second–Order Corrector

We notice that the velocity second–order corrector is of shape and scale that will affect our asymptotic approximation if  $\epsilon$  is not too small (e.g.  $\epsilon = 0.1$ ). This has been visually verified in Section A.5.2. The microrotation second–order corrector does not affect the asymptotic approximation in a significant way as the first–order corrector is of the same shape and similar scale. Note that the second–order correctors are scaled with the small parameter  $\epsilon^4$  in the asymptotic approximation (A.42).

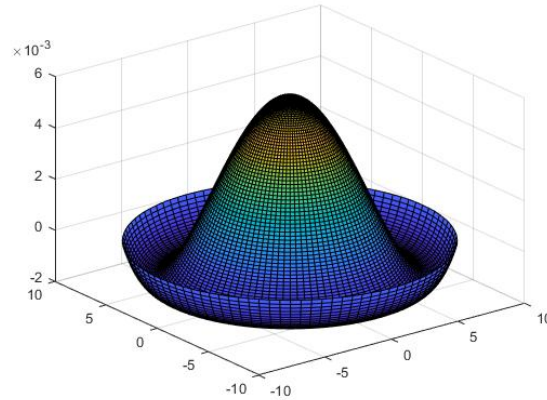

**Figure A.2:** Second-order velocity corrector  $\epsilon^4 \tilde{V}_2^2$ .

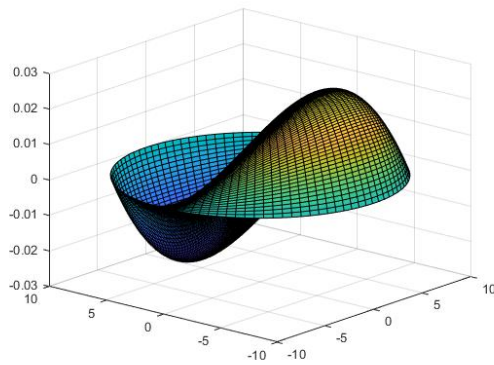

(a) Second-order microrotation corrector  $\epsilon^4 \tilde{W}_2^{2,2}$ .

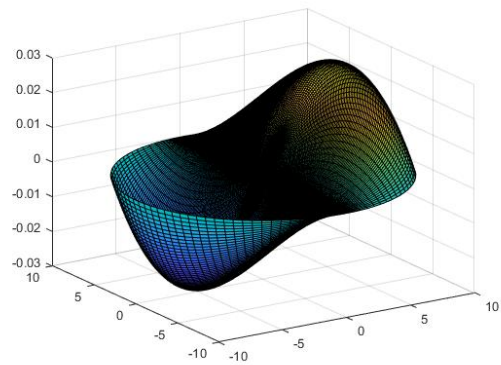

(b) Second-order microrotation corrector  $\epsilon^4 \tilde{W}_2^{3,2}$ .

**Figure A.3:** Second-order microrotation correctors.

## A.5.2 Asymptotic Approximation

In Fig. A.4, we compare our asymptotic approximation  $v_{\epsilon,[2]}$  and the zero-order approximation  $\tilde{V}_2^0$ . The second order corrector for the velocity affects the approximation in the whole domain, with a clear impact near the boundary of the domain, correcting the Poiseuille zero-order approximation, and we can clearly observe the effect visually. The microrotation approximation is the scaled sum of the first and second order corrector, thus having the same form as the first and second-order correctors (see Fig. A.5).

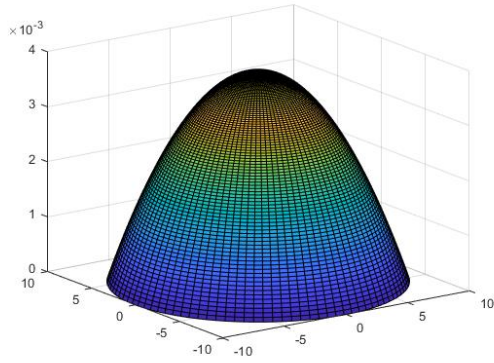

(a) Zero-order approximation  $\epsilon^2 \tilde{V}_0^2$ .

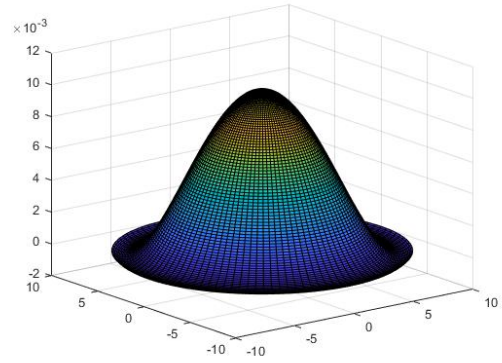

(b) Velocity approximation  $v_{\epsilon,[2]}$ .

**Figure A.4:** Comparison of velocity zero-order and asymptotic approximation.

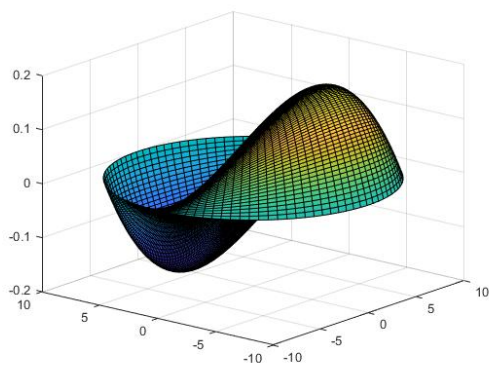

(a) Asymptotic approximation  $w_{\epsilon,[2]}^2$ .

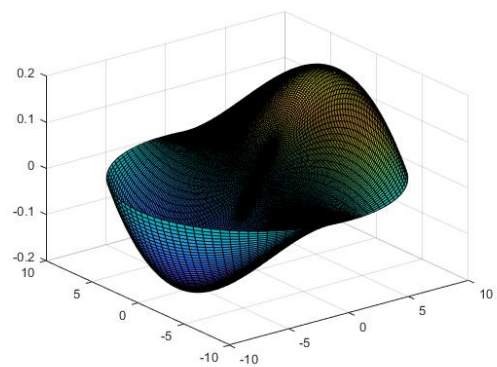

(b) Asymptotic approximation  $w_{\epsilon,[3]}^3$ .

**Figure A.5:** Microrotation asymptotic approximation.

## Appendix B

# Differential Operators in Curvilinear Coordinates

In this Appendix, we provide the explicit expressions for the differential operators in curvilinear coordinates which we employed in Chapter 4. The detailed proofs of the formulae can be found in [2].

### B.1 Time Derivative Operator

The time derivative operator in curvilinear coordinates is given by:

$$\left(\frac{\partial \tilde{\mathbf{v}}_\epsilon}{\partial \tilde{t}}\right) \circ \tilde{\Phi}_\epsilon^\alpha = \begin{bmatrix} \frac{\partial \tilde{v}_\epsilon^1}{\partial \tilde{t}} \\ \frac{\partial \tilde{v}_\epsilon^2}{\partial \tilde{t}} \\ \frac{\partial \tilde{v}_\epsilon^3}{\partial \tilde{t}} \end{bmatrix} \circ \tilde{\Phi}_\epsilon^\alpha = \mathbf{B} \begin{bmatrix} \frac{1}{1 - \kappa(e_\alpha \cdot x')} \frac{\partial U_\epsilon^1}{\partial t} \\ \frac{\partial U_\epsilon^2}{\partial t} \cos \alpha - \frac{\partial U_\epsilon^3}{\partial t} \sin \alpha \\ \frac{\partial U_\epsilon^2}{\partial t} \sin \alpha + \frac{\partial U_\epsilon^3}{\partial t} \cos \alpha \end{bmatrix}.$$

### B.2 Gradient Operator

The gradient operator in curvilinear coordinates reads:

$$(\nabla_{S_\epsilon})^t \circ \tilde{\Phi}_\epsilon^\alpha = \begin{bmatrix} \frac{\partial S_\epsilon}{\partial \tilde{x}_1} \\ \frac{\partial S_\epsilon}{\partial \tilde{x}_2} \\ \frac{\partial S_\epsilon}{\partial \tilde{x}_3} \end{bmatrix} \circ \tilde{\Phi}_\epsilon^\alpha = (\nabla \Phi_\epsilon^\alpha)^{-t} (\nabla S_\epsilon)^t = \mathbf{B} \begin{bmatrix} \frac{1}{1 - \kappa(e_\alpha \cdot x')} \frac{\partial S_\epsilon}{\partial x_1} \\ \cos \alpha \frac{\partial S_\epsilon}{\partial x_2} - \sin \alpha \frac{\partial S_\epsilon}{\partial x_3} \\ \sin \alpha \frac{\partial S_\epsilon}{\partial x_2} + \cos \alpha \frac{\partial S_\epsilon}{\partial x_3} \end{bmatrix},$$

and

$$(\nabla \tilde{\mathbf{v}}_\epsilon) \circ \tilde{\Phi}_\epsilon^\alpha = (\nabla \Phi_\epsilon^\alpha)^{-t} \left( \left[ \frac{\partial U_\epsilon^k}{\partial x_l} \right]_{k,l} - U_\epsilon^j \mathbf{\Gamma}^j \right) (\nabla \Phi_\epsilon^\alpha)^{-1},$$



which we rewrite as

$$(\nabla \tilde{\mathbf{v}}_\epsilon) \circ \tilde{\Phi}_\epsilon^\alpha = \mathbf{B} \mathbf{A} \mathbf{B}^t,$$

where

$$\begin{aligned} [\mathbf{A}]_{11} &= \left( \frac{1}{1 - \kappa(e_\alpha \cdot x')} \right)^2 \left( \frac{\partial U_\epsilon^1}{\partial x_1} - \kappa(U_\epsilon^2 \cos \alpha - U_\epsilon^3 \sin \alpha) + (\kappa'(e_\alpha \cdot x') + \kappa\tau(e_\alpha^\perp \cdot x'))U_\epsilon^1 \right) \\ &\quad + \left( \frac{1}{1 - \kappa(e_\alpha \cdot x')} \right)^2 \left( \kappa(e_\alpha \cdot x')(\kappa'(e_\alpha \cdot x') + \kappa\tau(e_\alpha^\perp \cdot x'))U_\epsilon^1 \right) \\ &\quad + \left( \frac{1}{1 - \kappa(e_\alpha \cdot x')} \right)^2 \left( \kappa^2(e_\alpha \cdot x') \cos \alpha U_\epsilon^2 - \kappa^2(e_\alpha \cdot x') \sin \alpha U_\epsilon^3 \right), \\ [\mathbf{A}]_{12} &= \frac{1}{1 - \kappa(e_\alpha \cdot x')} \left( \frac{\partial U_\epsilon^1}{\partial x_2} \cos \alpha + U_\epsilon^1 \kappa \cos^2 \alpha - \frac{\partial U_\epsilon^1}{\partial x_3} \sin \alpha + U_\epsilon^1 \kappa \sin^2 \alpha + \dots \right) \\ &= \frac{1}{1 - \kappa(e_\alpha \cdot x')} \left( \frac{\partial U_\epsilon^1}{\partial x_2} \cos \alpha - \frac{\partial U_\epsilon^1}{\partial x_3} \sin \alpha + \kappa U_\epsilon^1 + \dots \right), \\ [\mathbf{A}]_{13} &= \frac{1}{1 - \kappa(e_\alpha \cdot x')} \left( \frac{\partial U_\epsilon^1}{\partial x_2} \sin \alpha + U_\epsilon^1 \kappa \sin \alpha \cos \alpha + \frac{\partial U_\epsilon^1}{\partial x_3} \cos \alpha - U_\epsilon^1 \kappa \sin \alpha \cos \alpha + \dots \right) \\ &= \frac{1}{1 - \kappa(e_\alpha \cdot x')} \left( \frac{\partial U_\epsilon^1}{\partial x_2} \sin \alpha + \frac{\partial U_\epsilon^1}{\partial x_3} \cos \alpha + \dots \right), \\ [\mathbf{A}]_{21} &= \frac{1}{1 - \kappa(e_\alpha \cdot x')} \left( \cos \alpha \frac{\partial U_\epsilon^2}{\partial x_1} - \sin \alpha \frac{\partial U_\epsilon^3}{\partial x_1} + \kappa U_\epsilon^1 + \dots \right), \\ [\mathbf{A}]_{22} &= \frac{\partial U_\epsilon^2}{\partial x_2} \cos^2 \alpha - \frac{\partial U_\epsilon^3}{\partial x_2} \sin \alpha \cos \alpha - \frac{\partial U_\epsilon^2}{\partial x_3} \cos \alpha \sin \alpha + \frac{\partial U_\epsilon^3}{\partial x_3} \sin^2 \alpha \\ &= \frac{\partial U_\epsilon^2}{\partial x_2} \cos^2 \alpha + \frac{\partial U_\epsilon^3}{\partial x_3} \sin^2 \alpha - \frac{1}{2} \sin 2\alpha \left( \frac{\partial U_\epsilon^3}{\partial x_2} + \frac{\partial U_\epsilon^2}{\partial x_3} \right), \\ [\mathbf{A}]_{23} &= \frac{\partial U_\epsilon^2}{\partial x_2} \cos \alpha \sin \alpha - \frac{\partial U_\epsilon^3}{\partial x_2} \sin^2 \alpha + \frac{\partial U_\epsilon^2}{\partial x_3} \cos^2 \alpha - \frac{\partial U_\epsilon^3}{\partial x_3} \sin \alpha \cos \alpha \\ &= \frac{\partial U_\epsilon^2}{\partial x_3} \cos^2 \alpha - \frac{\partial U_\epsilon^3}{\partial x_2} \sin^2 \alpha + \frac{1}{2} \sin 2\alpha \left( \frac{\partial U_\epsilon^2}{\partial x_2} - \frac{\partial U_\epsilon^3}{\partial x_3} \right), \\ [\mathbf{A}]_{31} &= \frac{1}{1 - \kappa(e_\alpha \cdot x')} \left( \sin \alpha \frac{\partial U_\epsilon^2}{\partial x_1} + \cos \alpha \frac{\partial U_\epsilon^3}{\partial x_1} + \dots \right), \\ [\mathbf{A}]_{32} &= \frac{\partial U_\epsilon^2}{\partial x_2} \cos \alpha \sin \alpha + \frac{\partial U_\epsilon^3}{\partial x_2} \cos^2 \alpha - \frac{\partial U_\epsilon^2}{\partial x_3} \sin^2 \alpha - \frac{\partial U_\epsilon^3}{\partial x_3} \sin \alpha \cos \alpha \\ &= \frac{\partial U_\epsilon^3}{\partial x_2} \cos^2 \alpha - \frac{\partial U_\epsilon^2}{\partial x_3} \sin^2 \alpha + \frac{1}{2} \sin 2\alpha \left( \frac{\partial U_\epsilon^2}{\partial x_2} - \frac{\partial U_\epsilon^3}{\partial x_3} \right), \\ [\mathbf{A}]_{33} &= \frac{\partial U_\epsilon^2}{\partial x_2} \sin^2 \alpha + \frac{\partial U_\epsilon^3}{\partial x_2} \cos \alpha \sin \alpha + \frac{\partial U_\epsilon^2}{\partial x_3} \sin \alpha \cos \alpha + \frac{\partial U_\epsilon^3}{\partial x_3} \cos^2 \alpha \\ &= \frac{\partial U_\epsilon^2}{\partial x_2} \sin^2 \alpha + \frac{\partial U_\epsilon^3}{\partial x_3} \cos^2 \alpha + \frac{1}{2} \sin 2\alpha \left( \frac{\partial U_\epsilon^3}{\partial x_2} + \frac{\partial U_\epsilon^2}{\partial x_3} \right). \end{aligned}$$

## B.3 Divergence Operator

The divergence operator in curvilinear coordinates is given by:

$$(\operatorname{div} \tilde{\mathbf{v}}_\epsilon) \circ \tilde{\Phi}_\epsilon^\alpha = \operatorname{tr}((\nabla \tilde{\mathbf{v}}_\epsilon) \circ \tilde{\Phi}_\epsilon^\alpha),$$

leading to

$$\begin{aligned} \operatorname{div} \tilde{\mathbf{v}}_\epsilon \circ \tilde{\Phi}_\epsilon^\alpha &= \left( \frac{1}{1 - \kappa(e_\alpha \cdot x')} \right)^2 \left( \frac{\partial U_\epsilon^1}{\partial x_1} - \kappa(U_\epsilon^2 \cos \alpha - U_\epsilon^3 \sin \alpha) \right. \\ &\quad + (\kappa'(e_\alpha \cdot x') + \kappa\tau(e_\alpha^\perp \cdot x'))U_\epsilon^1 + \kappa(e_\alpha \cdot x')(\kappa'(e_\alpha \cdot x') + \kappa\tau(e_\alpha^\perp \cdot x'))U_\epsilon^1 \\ &\quad \left. + \kappa^2(e_\alpha \cdot x') \cos \alpha U_\epsilon^2 - \kappa^2(e_\alpha \cdot x') \sin \alpha U_\epsilon^3 \right) + \frac{\partial U_\epsilon^2}{\partial x_2} + \frac{\partial U_\epsilon^3}{\partial x_3} \\ &= \frac{\partial U_\epsilon^1}{\partial x_1} - \kappa(U_\epsilon^2 \cos \alpha - U_\epsilon^3 \sin \alpha) + (\kappa'(e_\alpha \cdot x') + \kappa\tau(e_\alpha^\perp \cdot x'))U_\epsilon^1 \\ &\quad + \kappa(e_\alpha \cdot x')(\kappa'(e_\alpha \cdot x') + \kappa\tau(e_\alpha^\perp \cdot x'))U_\epsilon^1 \\ &\quad + \kappa^2(e_\alpha \cdot x') \cos \alpha U_\epsilon^2 - \kappa^2(e_\alpha \cdot x') \sin \alpha U_\epsilon^3 + \frac{\partial U_\epsilon^2}{\partial x_2} + \frac{\partial U_\epsilon^3}{\partial x_3} \\ &\quad + 2\kappa(e_\alpha \cdot x') \left( \frac{\partial U_\epsilon^1}{\partial x_1} - \kappa(U_\epsilon^2 \cos \alpha - U_\epsilon^3 \sin \alpha) + (\kappa'(e_\alpha \cdot x') + \kappa\tau(e_\alpha^\perp \cdot x'))U_\epsilon^1 \right) \\ &\quad + 2\kappa(e_\alpha \cdot x') \left( \kappa^2(e_\alpha \cdot x') \cos \alpha U_\epsilon^2 - \kappa^2(e_\alpha \cdot x') \sin \alpha U_\epsilon^3 \right) \\ &\quad + 3\kappa^2(e_\alpha \cdot x')^2 \left( \frac{\partial U_\epsilon^1}{\partial x_1} - \kappa(U_\epsilon^2 \cos \alpha - U_\epsilon^3 \sin \alpha) \right) + 4\kappa^3(e_\alpha \cdot x')^3 \frac{\partial U_\epsilon^1}{\partial x_1} + \dots \end{aligned}$$

## B.4 Gradient Divergence Operator

The gradient divergence operator in curvilinear coordinates reads:

$$\begin{aligned} (\nabla(\operatorname{div} \tilde{\mathbf{v}}_\epsilon))^t \circ \tilde{\Phi}_\epsilon^\alpha &= (\nabla \Phi_\epsilon^\alpha)^{-t} (\nabla \operatorname{div} \mathbf{V}_\epsilon)^t \\ &= \mathbf{B} \begin{bmatrix} (1 + \kappa(e_\alpha \cdot x') + \dots) \frac{\partial}{\partial x_1} (\operatorname{div} \mathbf{V}_\epsilon) \\ \cos \alpha \frac{\partial}{\partial x_2} (\operatorname{div} \mathbf{V}_\epsilon) - \sin \alpha \frac{\partial}{\partial x_3} (\operatorname{div} \mathbf{V}_\epsilon) \\ \sin \alpha \frac{\partial}{\partial x_2} (\operatorname{div} \mathbf{V}_\epsilon) + \cos \alpha \frac{\partial}{\partial x_3} (\operatorname{div} \mathbf{V}_\epsilon) \end{bmatrix} = \mathbf{B} \mathbf{D}, \end{aligned}$$

where

$$\begin{aligned} [\mathbf{D}]_1 &= (1 + \kappa(e_\alpha \cdot x') + \dots) \left( \frac{\partial^2 U_\epsilon^1}{\partial x_1^2} - (\kappa \cos \alpha)' U_\epsilon^2 - \kappa \cos \alpha \frac{\partial U_\epsilon^2}{\partial x_1} + (\kappa \sin \alpha)' U_\epsilon^3 \right. \\ &\quad \left. + \kappa \sin \alpha \frac{\partial U_\epsilon^3}{\partial x_1} + \frac{\partial^2 U_\epsilon^2}{\partial x_1 \partial x_2} + \frac{\partial^2 U_\epsilon^3}{\partial x_1 \partial x_3} + \dots \right), \\ [\mathbf{D}]_2 &= \cos \alpha \frac{\partial^2 U_\epsilon^1}{\partial x_1 \partial x_2} - \sin \alpha \frac{\partial^2 U_\epsilon^1}{\partial x_1 \partial x_3} - \kappa \cos \alpha \left( \frac{\partial U_\epsilon^2}{\partial x_2} \cos \alpha - \frac{\partial U_\epsilon^3}{\partial x_2} \sin \alpha \right) \end{aligned}$$

$$\begin{aligned}
 & + \kappa \sin \alpha \left( \frac{\partial U_\epsilon^2}{\partial x_3} \cos \alpha - \frac{\partial U_\epsilon^3}{\partial x_3} \sin \alpha \right) + \kappa' U_\epsilon^1 + \kappa' (e_\alpha \cdot x') \left( \frac{\partial U_\epsilon^1}{\partial x_2} \cos \alpha - \frac{\partial U_\epsilon^1}{\partial x_3} \sin \alpha \right) \\
 & + \kappa \tau (e_\alpha^\perp \cdot x') \left( \frac{\partial U_\epsilon^1}{\partial x_2} \cos \alpha - \frac{\partial U_\epsilon^1}{\partial x_3} \sin \alpha \right) + \kappa^2 \cos \alpha U_\epsilon^2 - \kappa^2 \sin \alpha U_\epsilon^3 \\
 & + \kappa^2 (e_\alpha \cdot x') \cos \alpha \left( \frac{\partial U_\epsilon^2}{\partial x_2} \cos \alpha - \frac{\partial U_\epsilon^2}{\partial x_3} \sin \alpha \right) \\
 & - \kappa^2 (e_\alpha \cdot x') \sin \alpha \left( \cos \alpha \frac{\partial U_\epsilon^3}{\partial x_2} - \sin \alpha \frac{\partial U_\epsilon^3}{\partial x_3} \right) \\
 & + \cos \alpha \frac{\partial^2 U_\epsilon^2}{\partial x_2^2} + \cos \alpha \frac{\partial^2 U_\epsilon^3}{\partial x_2 \partial x_3} - \sin \alpha \frac{\partial^2 U_\epsilon^2}{\partial x_2 \partial x_3} - \sin \alpha \frac{\partial^2 U_\epsilon^3}{\partial x_3^2} \\
 & + 2\kappa \left( \frac{\partial U_\epsilon^1}{\partial x_1} - \kappa (U_\epsilon^2 \cos \alpha - U_\epsilon^3 \sin \alpha) \right) + 2\kappa (e_\alpha \cdot x') \left( \cos \alpha \frac{\partial^2 U_\epsilon^1}{\partial x_1 \partial x_2} - \sin \alpha \frac{\partial^2 U_\epsilon^1}{\partial x_1 \partial x_3} \right. \\
 & \left. - \kappa \cos \alpha \left( \frac{\partial U_\epsilon^2}{\partial x_2} \cos \alpha - \frac{\partial U_\epsilon^3}{\partial x_2} \sin \alpha \right) + \kappa \sin \alpha \left( \frac{\partial U_\epsilon^2}{\partial x_3} \cos \alpha - \frac{\partial U_\epsilon^3}{\partial x_3} \sin \alpha \right) \right) + \dots, \\
 [\mathbf{D}]_3 = & \sin \alpha \frac{\partial^2 U_\epsilon^1}{\partial x_1 \partial x_2} + \cos \alpha \frac{\partial^2 U_\epsilon^1}{\partial x_1 \partial x_3} - \kappa \sin \alpha \left( \frac{\partial U_\epsilon^2}{\partial x_2} \cos \alpha - \frac{\partial U_\epsilon^3}{\partial x_2} \sin \alpha \right) \\
 & - \kappa \cos \alpha \left( \frac{\partial U_\epsilon^2}{\partial x_3} \cos \alpha - \frac{\partial U_\epsilon^3}{\partial x_3} \sin \alpha \right) + \kappa' (e_\alpha \cdot x') \left( \sin \alpha \frac{\partial U_\epsilon^1}{\partial x_2} + \cos \alpha \frac{\partial U_\epsilon^1}{\partial x_3} \right) + \kappa \tau U_\epsilon^1 \\
 & + \kappa \tau (e_\alpha^\perp \cdot x') \left( \sin \alpha \frac{\partial U_\epsilon^1}{\partial x_2} + \cos \alpha \frac{\partial U_\epsilon^1}{\partial x_3} \right) + \kappa^2 (e_\alpha \cdot x') \cos \alpha \left( \frac{\partial U_\epsilon^2}{\partial x_2} \sin \alpha + \frac{\partial U_\epsilon^2}{\partial x_3} \cos \alpha \right) \\
 & - \kappa^2 (e_\alpha \cdot x') \sin \alpha \left( \frac{\partial U_\epsilon^3}{\partial x_2} \sin \alpha + \frac{\partial U_\epsilon^3}{\partial x_3} \cos \alpha \right) + \sin \alpha \frac{\partial^2 U_\epsilon^2}{\partial x_2^2} + \sin \alpha \frac{\partial^2 U_\epsilon^3}{\partial x_2 \partial x_3} \\
 & + \cos \alpha \frac{\partial^2 U_\epsilon^2}{\partial x_2 \partial x_3} + \cos \alpha \frac{\partial^2 U_\epsilon^3}{\partial x_3^2} + 2\kappa (e_\alpha \cdot x') \left( \sin \alpha \frac{\partial^2 U_\epsilon^1}{\partial x_1 \partial x_2} + \cos \alpha \frac{\partial^2 U_\epsilon^1}{\partial x_1 \partial x_3} \right. \\
 & \left. - \kappa \sin \alpha \left( \frac{\partial U_\epsilon^2}{\partial x_2} \cos \alpha - \frac{\partial U_\epsilon^3}{\partial x_2} \sin \alpha \right) - \kappa \cos \alpha \left( \frac{\partial U_\epsilon^2}{\partial x_3} \cos \alpha - \frac{\partial U_\epsilon^3}{\partial x_3} \sin \alpha \right) \right) + \dots
 \end{aligned}$$

## B.5 Laplace Operator

The Laplace operator in curvilinear coordinates is given by:

$$\begin{aligned}
 (\Delta \tilde{\mathbf{v}}_\epsilon) \circ \tilde{\Phi}_\epsilon^\alpha &= (\nabla \Phi_\epsilon^\alpha)^{-t} \left( \frac{\partial}{\partial x_i} \left( \left[ \frac{\partial U_\epsilon^k}{\partial x_l} \right]_{k,l} - U_\epsilon^j \Gamma^j \right) - \left( \left[ \frac{\partial U_\epsilon^k}{\partial x_l} \right]_{k,l} - U_\epsilon^j \Gamma^j \right) \hat{\Gamma}_i \right. \\
 & \left. - \tilde{\Gamma}_i^t \left( \left[ \frac{\partial U_\epsilon^k}{\partial x_l} \right]_{k,l} - U_\epsilon^j \Gamma^j \right) \right) (\nabla \Phi_\epsilon^\alpha)^{-1} \mathbf{a}^i,
 \end{aligned}$$

which can be rewritten as

$$(\Delta \tilde{\mathbf{v}}_\epsilon) \circ \tilde{\Phi}_\epsilon^\alpha = \mathbf{B}\mathbf{E},$$

where

$$\begin{aligned}
[\mathbf{E}]_1 &= \frac{1}{1 - \kappa(e_\alpha \cdot x')} \frac{1}{1 - 2\kappa(e_\alpha \cdot x')} \left( \frac{\partial^2 U_\epsilon^1}{\partial x_1^2} - \frac{\partial U_\epsilon^2}{\partial x_1} \kappa \cos \alpha - U_\epsilon^2 (\kappa \cos \alpha)' + \frac{\partial U_\epsilon^3}{\partial x_1} \kappa \sin \alpha \right) \\
&\quad - \frac{1}{1 - \kappa(e_\alpha \cdot x')} \frac{1}{1 - 2\kappa(e_\alpha \cdot x')} \left( -U_\epsilon^3 (\kappa \sin \alpha)' + \frac{\partial U_\epsilon^1}{\partial x_2} \kappa \cos \alpha - \frac{\partial U_\epsilon^1}{\partial x_3} \kappa \sin \alpha + \kappa^2 U_\epsilon^1 \right) \\
&\quad - \frac{1}{1 - \kappa(e_\alpha \cdot x')} \frac{1}{1 - 2\kappa(e_\alpha \cdot x')} \left( -\kappa^2 \cos \alpha (e_\alpha \cdot x') \frac{\partial U_\epsilon^1}{\partial x_2} + \kappa^2 \sin \alpha (e_\alpha \cdot x') \frac{\partial U_\epsilon^1}{\partial x_3} \right) \\
&\quad + \frac{1}{1 - \kappa(e_\alpha \cdot x')} \frac{1}{1 - 2\kappa(e_\alpha \cdot x')} \left( -\frac{\partial U_\epsilon^2}{\partial x_1} \kappa \cos \alpha + \frac{\partial U_\epsilon^3}{\partial x_1} \kappa \sin \alpha - \kappa^2 U_\epsilon^1 \right) \\
&\quad + \frac{1}{1 - \kappa(e_\alpha \cdot x')} \left( \frac{\partial^2 U_\epsilon^1}{\partial x_2^2} + \frac{\partial U_\epsilon^1}{\partial x_2} \kappa \cos \alpha \right) \\
&\quad + \frac{1}{1 - \kappa(e_\alpha \cdot x')} \left( \kappa \cos \alpha \frac{\partial U_\epsilon^1}{\partial x_2} - \frac{\partial U_\epsilon^1}{\partial x_2} \kappa^2 \cos \alpha (e_\alpha \cdot x') + \frac{\partial^2 U_\epsilon^1}{\partial x_3^2} - \frac{\partial U_\epsilon^1}{\partial x_3} \kappa \sin \alpha \right) \\
&\quad + \frac{1}{1 - \kappa(e_\alpha \cdot x')} \left( -\frac{\partial U_\epsilon^1}{\partial x_3} \kappa \sin \alpha + \kappa^2 \sin \alpha (e_\alpha \cdot x') \frac{\partial U_\epsilon^1}{\partial x_3} \right), \\
[\mathbf{E}]_2 &= \frac{1}{1 - 2\kappa(e_\alpha \cdot x')} \left( \frac{\partial U_\epsilon^2}{\partial x_1^2} \cos \alpha - \frac{\partial^2 U_\epsilon^3}{\partial x_1^2} \sin \alpha + \kappa' U_\epsilon^1 + \kappa \frac{\partial U_\epsilon^1}{\partial x_1} - \kappa \cos^2 \alpha \frac{\partial U_\epsilon^2}{\partial x_2} \right) \\
&\quad + \frac{1}{1 - 2\kappa(e_\alpha \cdot x')} \left( \frac{\kappa}{2} \sin 2\alpha \frac{\partial U_\epsilon^2}{\partial x_3} + \frac{\kappa}{2} \sin 2\alpha \frac{\partial U_\epsilon^3}{\partial x_2} \right) \\
&\quad + \frac{1}{1 - 2\kappa(e_\alpha \cdot x')} \left( -\kappa \sin^2 \alpha \frac{\partial U_\epsilon^3}{\partial x_3} + \kappa^2 \cos^2 \alpha (e_\alpha \cdot x') \frac{\partial U_\epsilon^2}{\partial x_2} \right) \\
&\quad + \frac{1}{1 - 2\kappa(e_\alpha \cdot x')} \left( -\kappa^2 \sin \alpha \cos \alpha (e_\alpha \cdot x') \frac{\partial U_\epsilon^2}{\partial x_3} - \kappa^2 \sin \alpha \cos \alpha (e_\alpha \cdot x') \frac{\partial U_\epsilon^3}{\partial x_2} \right) \\
&\quad + \frac{1}{1 - 2\kappa(e_\alpha \cdot x')} \left( \kappa^2 (e_\alpha \cdot x') \sin^2 \alpha \frac{\partial U_\epsilon^3}{\partial x_3} + \kappa \frac{\partial U_\epsilon^1}{\partial x_1} - \kappa^2 (U_\epsilon^2 \cos \alpha - U_\epsilon^3 \sin \alpha) \right) \\
&\quad + \frac{\partial^2 U_\epsilon^2}{\partial x_2^2} \cos \alpha - \sin \alpha \frac{\partial^2 U_\epsilon^3}{\partial x_2^2} + \frac{\partial^2 U_\epsilon^2}{\partial x_3^2} \cos \alpha - \frac{\partial^2 U_\epsilon^3}{\partial x_3^2} \sin \alpha, \\
[\mathbf{E}]_3 &= \frac{1}{1 - 2\kappa(e_\alpha \cdot x')} \left( \frac{\partial^2 U_\epsilon^2}{\partial x_1^2} \sin \alpha + \frac{\partial^2 U_\epsilon^3}{\partial x_1^2} \cos \alpha + \kappa \tau U_\epsilon^1 - \frac{\kappa}{2} \sin 2\alpha \frac{\partial U_\epsilon^2}{\partial x_2} + \kappa \sin^2 \alpha \frac{\partial U_\epsilon^2}{\partial x_3} \right) \\
&\quad + \frac{1}{1 - 2\kappa(e_\alpha \cdot x')} \left( -\kappa \cos^2 \alpha \frac{\partial U_\epsilon^3}{\partial x_2} + \frac{\kappa}{2} \frac{\partial U_\epsilon^3}{\partial x_3} \sin 2\alpha + \kappa^2 \cos \alpha \sin \alpha (e_\alpha \cdot x') \frac{\partial U_\epsilon^2}{\partial x_2} \right) \\
&\quad + \frac{1}{1 - 2\kappa(e_\alpha \cdot x')} \left( -\kappa^2 \sin^2 \alpha (e_\alpha \cdot x') \frac{\partial U_\epsilon^2}{\partial x_3} + \kappa^2 \cos^2 \alpha (e_\alpha \cdot x') \frac{\partial U_\epsilon^3}{\partial x_2} \right) \\
&\quad + \frac{1}{1 - 2\kappa(e_\alpha \cdot x')} \left( -\kappa^2 \sin \alpha \cos \alpha (e_\alpha \cdot x') \frac{\partial U_\epsilon^3}{\partial x_3} \right) + \frac{\partial^2 U_\epsilon^2}{\partial x_2^2} \sin \alpha + \frac{\partial U_\epsilon^2}{\partial x_2^2} \cos \alpha \\
&\quad + \frac{\partial^2 U_\epsilon^2}{\partial x_3^2} \sin \alpha + \frac{\partial U_\epsilon^3}{\partial x_3^2} \cos \alpha.
\end{aligned}$$

## B.6 Rotation Operator

The rotation operator in curvilinear coordinates is given reads:

$$((\text{rot}\tilde{\mathbf{v}}_\epsilon) \circ \tilde{\Phi}_\epsilon^\alpha) \times \mathbf{c} = (\nabla\Phi_\epsilon^\alpha)^{-t}(\text{rot}\mathbf{V}_\epsilon \times (\nabla\Phi_\epsilon^\alpha)^{-1}\mathbf{c}), \quad \mathbf{c} \in \mathbb{R}^3,$$

leading to

$$(\text{rot}\tilde{\mathbf{v}}_\epsilon) \circ \tilde{\Phi}_\epsilon^\alpha = \mathbf{B} \left[ \begin{array}{c} \frac{\partial U_\epsilon^3}{\partial x_2} - \frac{\partial U_\epsilon^2}{\partial x_3} \\ \frac{1}{1 - \kappa(e_\alpha \cdot x')} \left( \cos \alpha \left( \frac{\partial U_\epsilon^1}{\partial x_3} - \frac{\partial U_\epsilon^3}{\partial x_1} \right) - \sin \alpha \left( \frac{\partial U_\epsilon^2}{\partial x_1} - \frac{\partial U_\epsilon^1}{\partial x_2} \right) \right) \\ \frac{1}{1 - \kappa(e_\alpha \cdot x')} \left( \sin \alpha \left( \frac{\partial U_\epsilon^1}{\partial x_3} - \frac{\partial U_\epsilon^3}{\partial x_1} \right) + \cos \alpha \left( \frac{\partial U_\epsilon^2}{\partial x_1} - \frac{\partial U_\epsilon^1}{\partial x_2} \right) \right) \end{array} \right].$$

# Appendix C

## Correctors and Boundary Layer Functions for the Curved-Pipe Flow

### C.1 Regular Part of the Expansion

In the following, we write down the functions (depending on  $x_1$  and  $t$ ) appearing in the computations for the first and second-order correctors (see (4.22), (4.28), (4.30), (4.31), (4.33), (4.35), (4.36), (4.38), (4.42) and (4.43)).

#### C.1.1 First-Order Corrector

The functions  $H^1(x_1, t)$  and  $H^2(x_1, t)$  in the problem (4.22) for the first component of the velocity first-order corrector  $V_1^1$  are given by:

$$\begin{aligned} H^1(x_1, t) &= \cos \alpha \left( -\frac{4\mu\kappa}{\pi} F_0^* - \kappa f^1 - \frac{\partial f^2}{\partial x_1} + \tau f^3 - \frac{a}{2\delta + \beta} g^3 \right) \\ &\quad + \sin \alpha \left( -\tau f^2 - \frac{\partial f^3}{\partial x_1} + \frac{a}{2\delta + \beta} g^2 \right), \\ H^2(x_1, t) &= \sin \alpha \left( \frac{4\mu\kappa}{\pi} F_0^* + \kappa f^1 + \frac{\partial f^2}{\partial x_1} - \tau f^3 - \frac{a}{2\delta + \beta} g^3 \right) \\ &\quad - \cos \alpha \left( \tau f^2 + \frac{\partial f^3}{\partial x_1} + \frac{a}{2\delta + \beta} g^2 \right). \end{aligned} \tag{C.1}$$

The functions  $H^3(x_1, t)$  and  $H^4(x_1, t)$  in the problem (4.28) for the first component of the microrotation first-order corrector  $W_1^1$  are given by:

$$\begin{aligned} H^3(x_1, t) &= -\frac{3\kappa}{2} g^1 \cos \alpha + \frac{\beta}{2\delta + \beta} \left( \left( \tau g^3 - \frac{\partial g^2}{\partial x_1} \right) \cos \alpha - \left( \tau g^2 + \frac{\partial g^3}{\partial x_1} \right) \sin \alpha \right), \\ H^4(x_1, t) &= \frac{3\kappa}{2} g^1 \sin \alpha - \frac{\beta}{2\delta + \beta} \left( \left( \tau g^2 + \frac{\partial g^3}{\partial x_1} \right) \cos \alpha + \left( \tau g^3 - \frac{\partial g^2}{\partial x_1} \right) \sin \alpha \right). \end{aligned} \tag{C.2}$$

The functions  $H^5(x_1, t), \dots, H^8(x_1, t)$  in the problem (4.30) for the second and third component of the microrotation first-order corrector  $(W_1^2, W_1^3)$  are given by:

$$\begin{aligned}
 H^5(x_1, t) &= \frac{\delta\kappa \cos \alpha}{2\delta + \beta} \left( g^2 \cos \alpha + g^3 \sin \alpha \right) + \frac{\beta\kappa}{2\delta + \beta} g^2 - \frac{\beta}{2\delta} \frac{\partial g^1}{\partial x_1}, \\
 H^6(x_1, t) &= -\frac{\delta\kappa \sin \alpha}{2\delta + \beta} (g^2 \cos \alpha + g^3 \sin \alpha) - \frac{4a}{\pi} F_0^*, \\
 H^7(x_1, t) &= \frac{\kappa\delta \cos \alpha}{2\delta + \beta} \left( g^3 \cos \alpha - g^2 \sin \alpha \right) + \frac{4a}{\pi} F_0^*, \\
 H^8(x_1, t) &= \frac{\delta\kappa \sin \alpha}{2\delta + \beta} \left( g^2 \sin \alpha - g^3 \cos \alpha \sin \alpha \right) + \frac{\beta\kappa}{2\delta + \beta} g^2 - \frac{\beta}{2\delta} \frac{\partial g^1}{\partial x_1}.
 \end{aligned} \tag{C.3}$$

The functions  $H^9(x_1, t), \dots, H^{12}(x_1, t)$  in the expressions (4.31) for the second and third component of the microrotation first-order corrector  $(W_1^2, W_1^3)$  are given by:

$$\begin{aligned}
 H^9(x_1, t) &= \frac{\beta H^8 - (4\delta + 3\beta) H^5}{2[\beta^2 - (4\delta + 3\beta)^2]}, \\
 H^{10}(x_1, t) &= \frac{\beta H^7 - (4\delta + \beta) H^6}{2[\beta^2 - (4\delta + \beta)^2]}, \\
 H^{11}(x_1, t) &= \frac{1}{2\beta} H^6 - \frac{4\delta + \beta}{\beta} \frac{\beta H^7 - (4\delta + \beta) H^6}{2[\beta^2 - (4\delta + \beta)^2]}, \\
 H^{12}(x_1, t) &= \frac{1}{2\beta} H^5 - \frac{4\delta + \beta}{\beta} \frac{\beta H^8 - (4\delta + \beta) H^5}{2[\beta^2 - (4\delta + \beta)^2]}.
 \end{aligned} \tag{C.4}$$

### C.1.2 Second-Order Corrector

The functions  $A^1(x_1, t), \dots, A^4(x_1, t)$  in the problem (4.33) for the first component of the velocity second-order corrector  $V_2^1$  are given as follows:

$$\begin{aligned}
 A^1(x_1, t) &= -\frac{2}{\pi\mu} \frac{d}{dt} F_0^* + \frac{3\kappa \cos \alpha}{8\mu} H^1 - \frac{\kappa \sin \alpha}{8\mu} H^2 - \frac{2\kappa^2}{\pi} F_0^* + \frac{\kappa}{\mu} \cos \alpha H^1 + \frac{4\kappa^2 \cos^2 \alpha}{\pi} F_0^* \\
 &\quad - \frac{\kappa^2}{\mu} \cos^2 \alpha \left( \frac{8\mu}{\pi} F_0^* - f^1 \right) + \frac{\kappa}{\mu} \left( \cos^2 \alpha \frac{\partial f^2}{\partial x_1} - \sin \alpha \cos \alpha f^2 \right) \\
 &\quad + \frac{\kappa}{\mu} \left( \cos \alpha \sin \alpha \frac{\partial f^3}{\partial x_1} + \cos^2 \alpha f^3 \right) - \frac{a}{\mu} \left( -3H^{11} + H^{10} \right), \\
 A^2(x_1, t) &= \frac{\kappa \cos \alpha}{4\mu} H^2 - \frac{\kappa \sin \alpha}{4\mu} H^1 + \frac{\kappa \cos \alpha}{\mu} H^2 - \frac{\kappa \sin \alpha}{\mu} H^1 - \frac{8\kappa^2 \cos \alpha \sin \alpha}{\pi} F_0^* \\
 &\quad + \frac{2\kappa^2 \sin \alpha \cos \alpha}{\mu} \left( \frac{8\mu}{\pi} F_0^* + f^1 \right) + \frac{\kappa}{\mu} \left( 2 \sin \alpha \cos \alpha \frac{\partial f^2}{\partial x_1} + (\cos^2 \alpha - \sin^2 \alpha) f^2 \right) \\
 &\quad - \frac{\kappa}{\mu} \left( \left( \cos^2 \alpha - \sin^2 \alpha \right) \frac{\partial f^3}{\partial x_1} - 2f^3 \sin \alpha \cos \alpha \right) + \frac{a}{\mu} \left( 2H^{12} - 2H^9 \right), \\
 A^3(x_1, t) &= -\frac{2}{\pi\mu} \frac{d}{dt} F_0^* + \frac{\kappa \cos \alpha}{8\mu} H^1 - \frac{3\kappa \sin \alpha}{8\mu} H^2 - \frac{2\kappa^2}{\pi} F_0^* - \frac{\kappa \sin \alpha}{\mu} H^2 \\
 &\quad + \frac{4\kappa^2 \sin^2 \alpha}{\pi} F_0^* - \frac{\kappa^2 \sin^2 \alpha}{\mu} \left( \frac{8}{\pi} F_0^* - f^1 \right) + \frac{\kappa}{\mu} \left( \frac{\partial f^2}{\partial x_1} \sin^2 \alpha - \sin \alpha \cos \alpha f^2 \right)
 \end{aligned}$$

$$\begin{aligned}
 & + \frac{\kappa}{\mu} \left( \frac{\partial f^3}{\partial x_1} \sin \alpha \cos \alpha + f^3 \sin^2 \alpha \right) - \frac{a}{\mu} \left( -H^{11} + 3H^{10} \right), \\
 A^4(x_1, t) = & \frac{2}{\mu\pi} \frac{d}{dt} F_0^* - \frac{\kappa \cos \alpha}{8\mu} H^1 + \frac{\kappa \sin \alpha}{8\mu} H^2 + \frac{2\kappa^2}{\pi} F_0^* + \frac{1}{\mu} p^1(t) \\
 & + \frac{1}{\mu} x_1 \left( \frac{p^2(t) - p^1(t)}{l} \right) - \frac{a}{\mu} \left( H^{11} - H^{10} \right). \tag{C.5}
 \end{aligned}$$

The functions  $A^5(x_1, t), \dots, A^{14}(x_1, t)$  in the problem (4.35) for the second and third component of the velocity second-order corrector and third-order pressure corrector ( $V_2^2, V_2^3, P_3$ ) are given as follows:

$$\begin{aligned}
 A^5(x_1, t) = & \frac{ag^1 \mu \kappa \sin \alpha}{16\mu\delta} + \frac{2\mu(\kappa' \cos \alpha + \kappa\tau \sin \alpha) F_0^*}{\pi} - aH^4 \\
 & + \frac{a}{2(2\delta + \beta)} \left( \frac{\partial g^3}{\partial x_1} \cos \alpha + g^3 \tau \sin \alpha - \frac{\partial g^2}{\partial x_1} \sin \alpha + \tau g^2 \cos \alpha \right), \\
 A^6(x_1, t) = & - \frac{ag^1 \mu \kappa \cos \alpha}{8\mu\delta} - 2aH^3 - \frac{a\kappa g^1 \cos \alpha}{2\delta}, \\
 A^7(x_1, t) = & - \frac{3ag^1 \mu \kappa \sin \alpha}{16\mu\delta} - \frac{2\mu(\kappa' \cos \alpha + \kappa\tau \sin \alpha) F_0^*}{\pi} - 3aH^4 + \frac{a\kappa \sin \alpha g^1}{2\delta} \\
 & + \frac{a}{2(2\delta + \beta)} \left( \frac{\partial g^3}{\partial x_1} \cos \alpha + g^3 \tau \sin \alpha - \frac{\partial g^2}{\partial x_1} \sin \alpha + \tau g^2 \cos \alpha \right), \\
 A^8(x_1, t) = & \frac{ag^1 \mu \kappa \sin \alpha}{16\mu\delta} + \frac{2\mu(\kappa' \cos \alpha + \kappa\tau \sin \alpha) F_0^*}{\pi} + aH^4 \\
 & - \frac{a}{2(2\delta + \beta)} \left( \frac{\partial g^3}{\partial x_1} \cos \alpha + g^3 \tau \sin \alpha - \frac{\partial g^2}{\partial x_1} \sin \alpha + \tau g^2 \cos \alpha \right), \\
 A^9(x_1, t) = & \frac{3a\kappa \cos \alpha g^1}{16\mu\delta} - \frac{2\mu(\kappa\tau \cos \alpha - \kappa' \sin \alpha) F_0^*}{\pi} \\
 & - \frac{a}{2(2\delta + \beta)} \left( \frac{\partial g^2}{\partial x_1} \cos \alpha + g^2 \tau \sin \alpha + \frac{\partial g^3}{\partial x_1} \sin \alpha - g^3 \tau \sin \alpha \right) \\
 & + 3aH^3 + \frac{ag^1 \kappa \cos \alpha}{2\delta}, \\
 A^{10}(x_1, t) = & - \frac{ag^1 \mu \kappa \sin \alpha}{8\mu\delta} + 2aH^4 - \frac{ag^1 \kappa \sin \alpha}{2\delta}, \\
 A^{11}(t, x_1) = & \frac{a\kappa \cos \alpha g^1}{16\mu\delta} - \frac{2\mu(\kappa\tau \cos \alpha - \kappa' \sin \alpha) F_0^*}{\pi} \\
 & - \frac{a}{2(2\delta + \beta)} \left( \frac{\partial g^2}{\partial x_1} \cos \alpha + g^2 \tau \sin \alpha + \frac{\partial g^3}{\partial x_1} \sin \alpha - g^3 \tau \sin \alpha \right) + aH^3, \\
 A^{12}(x_1, t) = & - \frac{ag^1 \mu \kappa \cos \alpha}{16\mu\delta} + \frac{2\mu(\kappa\tau \cos \alpha - \kappa' \sin \alpha) F_0^*}{\pi} \\
 & + \frac{a}{2(2\delta + \beta)} \left( \frac{\partial g^2}{\partial x_1} \cos \alpha + g^2 \tau \sin \alpha + \frac{\partial g^3}{\partial x_1} \sin \alpha - g^3 \tau \sin \alpha \right) - aH^3, \\
 A^{13}(x_1, t) = & \frac{1}{8\mu} \frac{\partial H^1}{\partial x_1} + \frac{a\kappa g^1 \sin \alpha}{16\mu\delta} + \frac{2\kappa' \cos \alpha + 2\kappa\tau \sin \alpha}{\pi} F_0^*,
 \end{aligned}$$



$$A^{14}(x_1, t) = \frac{1}{8\mu} \frac{\partial H^2}{\partial x_1} + \frac{a\kappa g^1 \cos \alpha}{16\mu\delta} + \frac{-2\kappa' \sin \alpha + 2\kappa\tau \cos \alpha}{\pi} F_0^*. \quad (\text{C.6})$$

The functions  $M^1(x_1, t), \dots, M^6(x_1, t)$  and  $B^5(x_1, t), \dots, B^{12}(x_1, t)$  in the expressions (4.36) for the second and third component of the velocity second-order corrector and third-order pressure corrector ( $V_2^2, V_2^3, P_3$ ) are given by:

$$\begin{aligned} M^1(x_1, t) &= \mu A^{13} + \frac{1}{3}A^5 - \frac{1}{12}A^7 + \frac{1}{24}A^{10}, \\ M^2(x_1, t) &= \frac{144}{147}\mu A^{14} + \frac{4}{147}A^6 - \frac{8}{147}A^9 + \frac{8}{147}A^{11}, \\ M^3(x_1, t) &= \mu A^{13} + \frac{1}{4}A^7 - \frac{3}{8}A^{10}, \\ M^4(x_1, t) &= \frac{96}{105}\mu A^{14} - \frac{8}{21}A^6 + \frac{5}{21}A^9 + \frac{17}{105}A^{11}, \\ M^5(x_1, t) &= -\frac{4}{3}\mu A^{13} + \frac{1}{6}A^7 - A^8 - \frac{5}{24}A^{10}, \\ M^6(x_1, t) &= -\frac{998}{735}\mu A^{14} - \frac{191}{882}A^6 + \frac{79}{441}A^9 + \frac{5491}{311640}A^{11} + A^{12}, \end{aligned} \quad (\text{C.7})$$

and

$$\begin{aligned} B^5(x_1, t) &= -\frac{21}{96\mu}M^1 + \frac{1}{96\mu}M^3 + \frac{7}{96\mu}A^5 - \frac{1}{96\mu}A^7, \quad B^6(x_1, t) = -\frac{1}{6\mu}M^4 + \frac{1}{12\mu}A^6, \\ B^7(x_1, t) &= \frac{3}{96\mu}M^1 - \frac{7}{96\mu}M^3 - \frac{1}{96\mu}A^5 + \frac{7}{96\mu}A^7, \\ B^8(x_1, t) &= -\frac{9}{96\mu}M^1 - \frac{3}{96\mu}M^3 + \frac{3}{96\mu}A^5 + \frac{3}{96\mu}A^7 - \frac{1}{4\mu}M^5 + \frac{1}{4\mu}A^8, \\ B^9(x_1, t) &= \frac{3}{96\mu}M^2 - \frac{7}{96\mu}M^4 + \frac{7}{96\mu}A^9 - \frac{1}{96\mu}A^{11}, \quad B^{10}(x_1, t) = -\frac{1}{6\mu}M^3 + \frac{1}{12\mu}A^{10}, \\ B^{11}(x_1, t) &= -\frac{21}{96\mu}M^2 + \frac{1}{96\mu}M^4 + \frac{7}{96\mu}A^{11} - \frac{1}{96\mu}A^9, \\ B^{12}(x_1, t) &= -\frac{9}{96\mu}M^2 - \frac{3}{96\mu}M^4 + \frac{3}{96\mu}A^9 + \frac{6}{96\mu}A^{11} - \frac{1}{4\mu}M^6 + \frac{1}{4\mu}A^{12}. \end{aligned} \quad (\text{C.8})$$

The functions  $C^1(x_1, t), \dots, C^4(x_1, t)$  in the problem (4.38) for the first component of the microrotation second-order corrector  $W_2^1$  are given as follows:

$$\begin{aligned} C^1(x_1, t) &= -\frac{1}{4\delta^2} \frac{\partial g^1}{\partial t} - \frac{1}{4\delta} \frac{\partial^2 g^1}{\partial x_1^2} + \frac{3\kappa \cos \alpha}{8\mu} H^3 \\ &\quad - \frac{1}{2\delta(2\delta + \beta)} \left( \frac{\partial g^2}{\partial x_1} \cos \alpha + \tau g^2 \sin \alpha + \frac{\partial g^3}{\partial x_1} \sin \alpha - \tau g^3 \cos \alpha \right) \\ &\quad + \frac{\kappa \sin \alpha}{2(2\delta + \beta)} \left( \frac{\partial g^3}{\partial x_1} \cos \alpha + \tau g^3 \sin \alpha - \frac{\partial g^2}{\partial x_1} \sin \alpha + \tau g^2 \cos \alpha \right) - \frac{\kappa \sin \alpha}{8\mu} H^4 \\ &\quad + \frac{1}{2(2\delta + \beta)} \frac{\partial}{\partial x_1} \left( \kappa \cos \alpha (g^2 \cos \alpha + g^3 \sin \alpha) \right) \end{aligned}$$

$$\begin{aligned}
& + \frac{1}{2(2\delta + \beta)} \frac{\partial}{\partial x_1} \left( -\kappa \sin \alpha (g^3 \cos \alpha - g^2 \sin \alpha) \right) \\
& - \frac{\kappa^2}{4\delta} g^1 + \frac{\kappa}{\mu} \cos \alpha H^3 + \frac{\kappa^2}{2\delta} \cos^2 \alpha g^1 + \frac{\beta}{4\delta^2} \frac{\partial^2 g^1}{\partial x_1^2} \\
& + \frac{\beta}{2\delta(2\delta + \beta)} \left( -(\kappa \cos \alpha)' (g^2 \cos \alpha + g^3 \sin \alpha) - \kappa \cos \alpha (g^2 \cos \alpha + g^3 \sin \alpha)' \right) \\
& + (\kappa \sin \alpha)' (g^3 \cos \alpha - g^2 \sin \alpha) + \kappa \sin \alpha (g^3 \cos \alpha - g^2 \sin \alpha)' \\
& + \frac{\beta \kappa}{\delta(2\delta + \beta)} \cos \alpha \left( \frac{\partial g^2}{\partial x_1} \cos \alpha + \tau g^2 \sin \alpha + \frac{\partial g^3}{\partial x_1} \sin \alpha - \tau g^3 \cos \alpha \right) \\
& + \frac{3\beta}{\delta} \frac{\partial H^9}{\partial x_1} + \frac{\beta}{\delta} \frac{\partial H^{12}}{\partial x_1} + \frac{4a^2}{16\mu\delta^2} g^1 - \frac{a}{2\delta^2} g^1, \\
C^2(x_1, t) & = \frac{\kappa \cos \alpha}{4\mu} H^4 - \frac{\kappa \sin \alpha}{4\mu} H^3 - \frac{\kappa \sin \alpha}{\mu} H^3 + \frac{\kappa}{\mu} \cos \alpha H^4 + \frac{\kappa^2 \sin \alpha \cos \alpha}{\delta} g^1 \\
& + \frac{2\beta}{\delta} \frac{\partial H^{11}}{\partial x_1} - \frac{\beta \kappa \sin \alpha}{\delta(2\delta + \beta)} \left( \frac{\partial g^2}{\partial x_1} \cos \alpha + \tau g^2 \sin \alpha + \frac{\partial g^3}{\partial x_1} \sin \alpha - \tau g^3 \cos \alpha \right) \\
& + \frac{\beta \kappa \cos \alpha}{\delta(2\delta + \beta)} \left( \frac{\partial g^3}{\partial x_1} \cos \alpha + \tau g^3 \sin \alpha - \frac{\partial g^2}{\partial x_1} \sin \alpha - \tau g^2 \cos \alpha \right), \\
C^3(x_1, t) & = -\frac{1}{4\delta^2} \frac{\partial g^1}{\partial t} - \frac{1}{4\delta} \frac{\partial^2 g^1}{\partial x_1^2} + \frac{\kappa \cos \alpha}{8\mu} H^3 - \frac{\kappa \cos \alpha}{2(2\delta + \beta)} \left( \frac{\partial g^2}{\partial x_1} \cos \alpha + \tau g^2 \sin \alpha \right) \\
& - \frac{\kappa \cos \alpha}{2(2\delta + \beta)} \left( \frac{\partial g^3}{\partial x_1} \sin \alpha - \tau g^3 \sin \alpha \right) - \frac{3\kappa \sin \alpha}{8\mu} H^4 \\
& + \kappa \sin \alpha \frac{1}{2(2\delta + \beta)} \left( \frac{\partial g^3}{\partial x_1} \cos \alpha + \tau g^3 \sin \alpha - \frac{\partial g^2}{\partial x_1} \sin \alpha + \tau g^2 \cos \alpha \right) \\
& + \frac{1}{2\delta(2\delta + \beta)} \left( \frac{\partial}{\partial x_1} \left( \kappa \cos \alpha (g^2 \cos \alpha + g^3 \sin \alpha) \right) \right) \\
& + \frac{1}{2\delta(2\delta + \beta)} \left( \frac{\partial}{\partial x_1} \left( -\kappa \sin \alpha (g^3 \cos \alpha - g^2 \sin \alpha) \right) \right) - \kappa^2 \frac{1}{4\delta} g^1 \\
& - \frac{\kappa}{\mu} \sin \alpha H^4 + \frac{\kappa^2 \sin^2 \alpha}{2\delta} g^1 + \frac{\beta}{4\delta^2} \frac{\partial^2 g^1}{\partial x_1^2} \\
& + \frac{\beta}{2\delta(2\delta + \beta)} \left( (\kappa \cos \alpha)' (g^2 \cos \alpha + g^3 \sin \alpha) \right. \\
& \left. - \kappa \cos \alpha (g^2 \cos \alpha + g^3 \sin \alpha)' + (\kappa \sin \alpha)' (g^3 \cos \alpha - g^2 \sin \alpha) \right. \\
& \left. + \kappa \sin \alpha (g^3 \cos \alpha - g^2 \sin \alpha)' \right) - \frac{\beta}{\delta} \frac{\partial H^9}{\partial x_1} + \frac{3\beta}{\delta} \frac{\partial H^{12}}{\partial x_1} \\
& - \frac{\beta \kappa \sin \alpha}{\delta(2\delta + \beta)} \left( \frac{\partial g^3}{\partial x_1} \cos \alpha + \tau g^3 \sin \alpha - \frac{\partial g^2}{\partial x_1} \sin \alpha + \tau g^2 \cos \alpha \right) + \frac{a^2 g^1}{4\mu\delta^2} - \frac{a g^1}{2\delta^2}, \\
C^4(x_1, t) & = \frac{1}{4\delta^2} \frac{\partial g^1}{\partial t} + \frac{1}{4\delta} \frac{\partial^2 g^1}{\partial x_1^2} - \frac{\kappa \cos \alpha}{8\mu} H^3 + \frac{\kappa \cos \alpha}{2\delta(2\delta + \beta)} \left( \frac{\partial g^2}{\partial x_1} \cos \alpha + \tau g^2 \sin \alpha \right) \\
& + \frac{\kappa \cos \alpha}{2\delta(2\delta + \beta)} \left( \frac{\partial g^3}{\partial x_1} \sin \alpha - \tau g^3 \sin \alpha \right) + \frac{\kappa \sin \alpha}{8\mu} H^4 \\
& - \frac{\kappa \sin \alpha}{2(2\delta + \beta)} \left( \frac{\partial g^3}{\partial x_1} \cos \alpha + \tau g^3 \sin \alpha - \frac{\partial g^2}{\partial x_1} \sin \alpha + \tau g^2 \cos \alpha \right)
\end{aligned}$$

$$\begin{aligned}
 & - \frac{1}{2(2\delta + \beta)} \frac{\partial}{\partial x_1} \left( \kappa \cos \alpha (g^2 \cos \alpha + g^3 \sin \alpha) \right) \\
 & - \frac{1}{2(2\delta + \beta)} \frac{\partial}{\partial x_1} \left( -\kappa \sin \alpha (g^3 \cos \alpha - g^2 \sin \alpha) \right) \\
 & + \frac{\kappa^2}{4\delta} g^1 - \frac{\beta}{4\delta^2} \frac{\partial^2 g^1}{\partial x_1^2} - \frac{\beta}{2\delta(2\delta + \beta)} \left( -(\kappa \cos \alpha)' (g^2 \cos \alpha + g^3 \sin \alpha) \right) \\
 & - \kappa \cos \alpha (g^2 \cos \alpha + g^3 \sin \alpha)' + (\kappa \sin \alpha)' (g^3 \cos \alpha - g^2 \sin \alpha) \\
 & + \kappa \sin \alpha (g^3 \cos \alpha - g^2 \sin \alpha)' + \frac{\beta}{\delta} \frac{\partial H^9}{\partial x_1} - \frac{\beta}{\delta} \frac{\partial H^{12}}{\partial x_1} - \frac{a^2}{8\mu\delta^2} g^1 + \frac{a}{2\delta^2} g^1. \quad (\text{C.9})
 \end{aligned}$$

The functions  $C^5(x_1, t), \dots, C^{12}(x_1, t)$  in the problem (4.42) for the second and third component of the microrotation second-order corrector  $(W_2^2, W_2^3)$  read:

$$\begin{aligned}
 C^5(x_1, t) = & \frac{1}{2\delta + \beta} \left( \frac{\partial g^2}{\partial t} \cos \alpha + \frac{\partial g^3}{\partial t} \sin \alpha \right) - \frac{\delta}{2(2\delta + \beta)} \left( \frac{\partial^2 g^2}{\partial x_1^2} \cos \alpha + \frac{\partial g^2}{\partial x_1} \tau \sin \alpha \right. \\
 & + \left( \tau' g^2 + \tau \frac{\partial g^2}{\partial x_1} \right) \sin \alpha - \tau^2 g^2 \cos \alpha + \frac{\partial^2 g^3}{\partial x_1^2} \sin \alpha - \frac{\partial g^3}{\partial x_1} \tau \cos \alpha \\
 & \left. - \left( \tau' g^3 + \tau \frac{\partial g^3}{\partial x_1} \right) \cos \alpha - \tau^2 g^3 \sin \alpha \right) + 3\delta\kappa \cos \alpha H^9 - \delta\kappa \sin \alpha H^{10} \\
 & + \frac{2\delta\kappa^2}{2\delta + \beta} \cos^2 \alpha (g^2 \cos \alpha + g^3 \sin \alpha) - \frac{1}{4} \left( \left( 2\kappa \frac{\partial g^1}{\partial x_1} + \kappa' g^1 - \frac{2\delta\kappa^2}{2\delta + \beta} g^2 \cos \alpha \right. \right. \\
 & \left. \left. - \frac{2\delta\kappa^2}{2\delta + \beta} g^3 \sin \alpha \right) \cos \alpha + \kappa\tau g^1 \sin \alpha \right) - \cos^2 \alpha \frac{\delta\kappa^2}{2\delta + \beta} (g^2 \cos \alpha + g^3 \sin \alpha) \\
 & - \frac{3\beta}{8\mu} \frac{\partial H^3}{\partial x_1} + 3\beta\kappa \cos \alpha H^9 - 3\beta\kappa \sin \alpha H^{11} \\
 & - \beta \cos \alpha \left( \frac{\kappa'}{4\delta} g^1 + \frac{\kappa^2 \cos \alpha}{2(2\delta + \beta)} (g^2 \cos \alpha + g^3 \sin \alpha) \right. \\
 & \left. - \frac{\kappa^2 \sin \alpha}{2(2\delta + \beta)} (g^3 \sin \alpha - g^2 \cos \alpha) \right. \\
 & \left. + 2\kappa \left( \frac{1}{4\delta} \frac{\partial g^1}{\partial x_1} - \kappa \left( \cos \alpha \frac{1}{2(2\delta + \beta)} (g^2 \cos \alpha + g^3 \sin \alpha) \right. \right. \right. \\
 & \left. \left. \left. - \sin \alpha \frac{1}{2(2\delta + \beta)} (g^3 \cos \alpha - g^2 \sin \alpha) \right) \right) \right) - \frac{\beta\kappa\tau}{4\delta} \sin \alpha g^1 \\
 & - \frac{\beta\kappa'}{2\delta} \cos \alpha g^1 - \frac{\beta\kappa\tau}{2\delta} \sin \alpha g^1 - \beta\kappa^2 \cos^2 \alpha \frac{1}{2\delta + \beta} (g^2 \cos \alpha + g^3 \sin \alpha) \\
 & - \beta\kappa \cos \alpha \left( \frac{1}{\delta} \frac{\partial g^1}{\partial x_1} - \kappa \left( \frac{1}{2\delta + \beta} \cos \alpha (g^2 \cos \alpha + g^3 \sin \alpha) \right. \right. \\
 & \left. \left. + \frac{1}{2\delta + \beta} \sin \alpha (g^3 \cos \alpha - g^2 \sin \alpha) \right) \right) - \frac{a}{8\mu} H^2 + \frac{a}{2\delta + \beta} (g^2 \cos \alpha + g^3 \sin \alpha), \\
 C^6(t, x_1) = & 2\delta\kappa \cos \alpha H^{10} - 2\delta\kappa \sin \alpha H^9 - \frac{2\delta\kappa^2}{2\delta + \beta} \sin \alpha \cos \alpha (g^2 \cos \alpha + g^3 \sin \alpha) - \frac{\beta}{4\mu} \frac{\partial H^4}{\partial x_1} \\
 & + 2\beta\kappa \cos \alpha H^{10} - 2\beta\kappa \sin \alpha H^{12} + \sin \alpha \frac{\beta\kappa' g^1}{2\delta} - \frac{\beta\kappa\tau}{2\delta} \cos \alpha g^1
 \end{aligned}$$

$$\begin{aligned}
 & + \beta \kappa^2 \sin \alpha \cos \alpha \frac{1}{2\delta + \beta} (g^2 \cos \alpha + g^3 \sin \alpha) \\
 & + \beta \kappa^2 \sin \alpha \cos \alpha (g^3 \cos \alpha - g^2 \sin \alpha) \\
 & - \beta \kappa \cos \alpha \frac{1}{\delta} \frac{\partial g^1}{\partial x_1} + 2\beta \kappa^2 \sin \alpha \cos \alpha \frac{1}{2\delta + \beta} (g^2 \cos \alpha + g^3 \sin \alpha) \\
 & - 2\beta \kappa^2 \sin^2 \alpha \frac{1}{2\delta + \beta} (g^3 \cos \alpha - g^2 \sin \alpha) - \frac{a}{4\mu} H^1 - \frac{4a\kappa}{\pi} \cos \alpha F_0^*, \\
 C^7(x_1, t) = & \frac{1}{2\delta + \beta} \left( \frac{\partial g^2}{\partial t} \cos \alpha + \frac{\partial g^3}{\partial t} \sin \alpha \right) - \frac{\delta}{2(2\delta + \beta)} \left( \frac{\partial^2 g^2}{\partial x_1^2} \cos \alpha + \frac{\partial g^2}{\partial x_1} \tau \sin \alpha \right. \\
 & + \left( \tau' g^2 + \tau \frac{\partial g^2}{\partial x_1} \right) \sin \alpha - \tau^2 g^2 \cos \alpha + \frac{\partial^2 g^3}{\partial x_1^2} \sin \alpha - \frac{\partial g^3}{\partial x_1} \tau \cos \alpha \\
 & - \left( \tau' g^3 + \tau \frac{\partial g^3}{\partial x_1} \right) \cos \alpha - \tau^2 g^3 \sin \alpha \left. \right) + \delta \kappa \cos \alpha H^9 - 3\delta \kappa \sin \alpha H^{10} \\
 & + \frac{2\delta \kappa^2}{2\delta + \beta} \sin^2 \alpha (g^2 \cos \alpha + g^3 \sin \alpha) - \frac{1}{4} \left( \left( 2\kappa \frac{\partial g^1}{\partial x_1} + \kappa' g^1 \right. \right. \\
 & \left. \left. - \frac{2\delta \kappa^2}{2\delta + \beta} (g^2 \cos \alpha + g^3 \sin \alpha) \right) \cos \alpha + \kappa \tau g^1 \sin \alpha \right) \\
 & + \kappa^2 \sin^2 \alpha \frac{\delta}{2\delta + \beta} (g^2 \cos \alpha + g^3 \sin \alpha) - \frac{\beta}{8\mu} \frac{\partial H^3}{\partial x_1} + \beta \kappa \cos \alpha H^9 \\
 & - \beta \kappa \sin \alpha H^{11} - \beta \cos \alpha \left( \frac{\kappa'}{4\delta} g^1 + \frac{\kappa^2 \cos \alpha}{2(2\delta + \beta)} (g^2 \cos \alpha + g^3 \sin \alpha) \right. \\
 & \left. - \frac{\kappa^2 \sin \alpha}{2(2\delta + \beta)} (g^2 \cos \alpha - g^3 \sin \alpha) + 2\kappa \left( \frac{1}{4\delta} \frac{\partial g^1}{\partial x_1} - \kappa \left( \cos \alpha \frac{1}{2(2\delta + \beta)} \right. \right. \right. \\
 & \left. \left. \left. (g^2 \cos \alpha + g^3 \sin \alpha) - \sin \alpha \frac{1}{2(2\delta + \beta)} (g^3 \cos \alpha - g^2 \sin \alpha) \right) \right) \right) - \sin \alpha \frac{\beta \kappa \tau}{4\delta} g^1 \\
 & - \beta \kappa^2 \sin^2 \alpha \frac{1}{2\delta + \beta} (g^3 \cos \alpha - g^2 \sin \alpha) - \frac{3a}{8\mu} H^2 + \frac{4a\kappa}{\pi} \sin \alpha F_0^* \\
 & - 2\beta \kappa \sin^2 \alpha \frac{1}{2\delta + \beta} (g^3 \cos \alpha - g^2 \sin \alpha) + \frac{a}{2\delta + \beta} (g^2 \cos \alpha + g^3 \sin \alpha), \\
 C^8(x_1, t) = & - \frac{1}{2\delta + \beta} \left( \frac{\partial g^2}{\partial t} \cos \alpha + \frac{\partial g^3}{\partial t} \sin \alpha \right) + \frac{\delta}{2(2\delta + \beta)} \left( \frac{\partial^2 g^2}{\partial x_1^2} \cos \alpha + \frac{\partial g^2}{\partial x_1} \tau \sin \alpha \right. \\
 & + \left( \tau' g^2 + \tau \frac{\partial g^2}{\partial x_1} \right) \sin \alpha - \tau^2 g^2 \cos \alpha + \frac{\partial^2 g^3}{\partial x_1^2} \sin \alpha - \frac{\partial g^3}{\partial x_1} \tau \cos \alpha \\
 & - \left( \tau' g^3 + \tau \frac{\partial g^3}{\partial x_1} \right) \cos \alpha - \tau^2 g^3 \sin \alpha \left. \right) - \delta \kappa \cos \alpha H^9 + \delta \kappa \sin \alpha H^{10} \\
 & + \frac{1}{4} \left( \left( 2\kappa \frac{\partial g^1}{\partial x_1} + \kappa' g^1 - \frac{2\delta \kappa^2}{2\delta + \beta} (g^2 \cos \alpha + g^3 \sin \alpha) \right) \cos \alpha + \kappa \tau g^1 \sin \alpha \right) \\
 & + \frac{\beta}{8\mu} \frac{\partial H^3}{\partial x_1} - \beta \kappa \cos \alpha H^9 + \beta \kappa \sin \alpha H^{11} \\
 & + \beta \cos \alpha \left( \frac{\kappa'}{4\delta} g^1 + \kappa^2 \cos \alpha \frac{1}{2(2\delta + \beta)} (g^2 \cos \alpha + g^3 \sin \alpha) \right. \\
 & \left. - \kappa^2 \sin \alpha \frac{1}{2(2\delta + \beta)} (g^2 \cos \alpha + g^3 \sin \alpha) \right)
 \end{aligned}$$

$$\begin{aligned}
 & + 2\kappa \left( \frac{1}{4\alpha} \frac{\partial g^1}{\partial x_1} - \kappa \left( \cos \alpha \frac{1}{2(2\delta + \beta)} (g^2 \cos \alpha + g^3 \sin \alpha) \right. \right. \\
 & \left. \left. - \sin \alpha \frac{1}{2(2\delta + \beta)} (g^3 \cos \alpha - g^2 \sin \alpha) \right) \right) \\
 & + \beta \kappa \tau \sin \alpha \frac{g^1}{4\delta} + \frac{a}{8\mu} H^2 - \frac{a}{2\delta + \beta} (g^2 \cos \alpha + g^3 \sin \alpha), \tag{C.10}
 \end{aligned}$$

and

$$\begin{aligned}
 C^9(x_1, t) = & \frac{1}{2(2\delta + \beta)} \left( \frac{\partial g^3}{\partial t} \cos \alpha - \frac{\partial g^2}{\partial t} \sin \alpha \right) - \frac{\delta}{2(2\delta + \beta)} \left( \frac{\partial^2 g^3}{\partial x_1^2} \cos \alpha + \tau \frac{\partial g^3}{\partial x_1} \sin \alpha \right. \\
 & + \left( \tau' g^3 + \tau \frac{\partial g^3}{\partial x_1} \right) \sin \alpha - \tau^2 g^3 \cos \alpha - \frac{\partial^2 g^2}{\partial x_1^2} \sin \alpha + \tau \frac{\partial g^2}{\partial x_1} \cos \alpha \\
 & + \left( \tau' g^2 + \tau \frac{\partial g^2}{\partial x_1} \right) \cos \alpha + \tau^2 g^2 \sin \alpha \left. \right) - \delta \kappa \sin \alpha H^{12} + 3\delta \kappa \cos \alpha H^{11} \\
 & + \frac{2\delta \kappa^2 \cos^2 \alpha}{2\delta + \beta} \left( g^3 \cos \alpha - g^2 \sin \alpha \right) - \left( \frac{\kappa \tau \cos \alpha}{4} g^1 - \left( \frac{\kappa}{2} \frac{\partial g^1}{\partial x_1} + \frac{\kappa'}{4} g^1 \right. \right. \\
 & \left. \left. - \frac{\kappa^2}{2(2\delta + \beta)} (g^2 \cos \alpha + g^3 \sin \alpha) \right) \sin \alpha \right) - \frac{\delta \kappa^2 \cos^2 \alpha}{2\delta + \beta} \left( g^3 \cos \alpha - g^2 \sin \alpha \right) \\
 & - \frac{\beta}{8\mu} \frac{\partial H^4}{\partial x_1} + \beta \kappa \cos \alpha H^{10} - \beta \kappa \sin \alpha H^{12} - \beta \kappa \tau \cos \alpha \frac{1}{4\delta} g^1 \\
 & + \beta \kappa \left( \kappa' \frac{1}{4\delta} g^1 + \kappa^2 \cos \alpha \frac{1}{2(2\delta + \beta)} (g^2 \cos \alpha + g^3 \sin \alpha) \right. \\
 & \left. - \kappa^2 \sin \alpha \frac{1}{2(2\delta + \beta)} (g^3 \cos \alpha - g^2 \sin \alpha) \right) \\
 & - 2\beta \kappa \left( \frac{1}{4\delta} \frac{\partial g^1}{\partial x_1} - \kappa \left( \cos \alpha \frac{1}{2(2\delta + \beta)} (g^2 \cos \alpha + g^3 \sin \alpha) \right. \right. \\
 & \left. \left. - \frac{1}{2(2\delta + \beta)} (g^3 \cos \alpha - g^2 \sin \alpha) \sin \alpha \right) \right) \sin \alpha + \frac{3a}{8\mu} H^1 \\
 & + \frac{4a\kappa}{\pi} F_0^* \cos \alpha + \frac{a}{2\delta + \beta} (g^3 \cos \alpha - g^2 \sin \alpha),
 \end{aligned}$$

$$\begin{aligned}
 C^{10}(x_1, t) = & - 2\delta \kappa \sin \alpha H^{11} + 2\delta \kappa \cos \alpha H^{12} - \frac{4\delta \kappa^2}{2\delta + \beta} \sin \alpha \cos \alpha (g^3 \cos \alpha - g^2 \sin \alpha) \\
 & + 2\delta \kappa^2 \cos \alpha \sin \alpha \frac{1}{2\delta + \beta} (g^3 \cos \alpha - g^2 \sin \alpha) - \frac{\beta}{4\mu} \frac{\partial H^3}{\partial x_1} + 2\beta \kappa \cos \alpha H^9 \\
 & - \beta \kappa \sin \alpha H^{11} - \beta \kappa' \cos \alpha \frac{1}{2\delta} g^1 - \beta \kappa \tau \sin \alpha \frac{1}{2\delta} g^1 - \beta \kappa^2 \cos^2 \alpha \frac{1}{2\delta + \beta} \\
 & (g^2 \cos \alpha + g^3 \sin \alpha) + \beta \kappa^2 \cos \alpha \sin \alpha \frac{1}{2\delta + \beta} (g^3 \cos \alpha - g^2 \sin \alpha) \\
 & - \beta \kappa \cos \alpha \frac{1}{\delta} \frac{\partial g^1}{\partial x_1} + 2\beta \kappa^2 \cos \alpha \frac{1}{2\delta + \beta} \left( \cos \alpha (g^2 \cos \alpha + g^3 \sin \alpha) \right. \\
 & \left. + \sin \alpha (g^3 \cos \alpha - g^2 \sin \alpha) \right) + \frac{a}{4\mu} H^2 - \frac{4a\kappa}{\pi} \sin \alpha F_0^*,
 \end{aligned}$$

$$C^{11}(x_1, t) = \frac{1}{2(2\delta + \beta)} \left( \frac{\partial g^3}{\partial t} \cos \alpha - \frac{\partial g^2}{\partial t} \sin \alpha \right) - \frac{\delta}{2(2\delta + \beta)} \left( \frac{\partial^2 g^3}{\partial x_1^2} \cos \alpha + \tau \frac{\partial g^3}{\partial x_1} \sin \alpha \right)$$

$$\begin{aligned}
 & + \left( \tau' g^3 + \tau \frac{\partial g^3}{\partial x_1} \right) \sin \alpha - \tau^2 g^3 \cos \alpha - \frac{\partial^2 g^2}{\partial x_1^2} \sin \alpha + \tau \frac{\partial g^2}{\partial x_1} \cos \alpha \\
 & + \left( \tau' g^2 + \tau \frac{\partial g^2}{\partial x_1} \right) \cos \alpha + \tau^2 g^2 \sin \alpha \Big) - 3\delta\kappa \sin \alpha H^{12} + \delta\kappa \cos \alpha H^{11} \\
 & + 2\delta\kappa^2 \sin^2 \alpha \frac{1}{2\delta + \beta} (g^3 \cos \alpha - g^2 \sin \alpha) \\
 & - \left( \cos \alpha \frac{\kappa\tau}{4} g^1 - \left( \frac{\kappa}{2} \frac{\partial g^1}{\partial x_1} + \frac{\kappa'}{4} g^1 \right) \sin \alpha \right) \\
 & + \frac{\kappa^2}{2(2\delta + \beta)} (g^2 \cos \alpha + g^3 \sin \alpha) \sin \alpha - \delta\kappa^2 \sin^2 \alpha \frac{1}{2\delta + \beta} (g^3 \cos \alpha - g^2 \sin \alpha) \\
 & - \frac{3\beta}{8\mu} \frac{\partial H^4}{\partial x_1} + 3\beta\kappa \cos \alpha H^{10} - 3\beta\kappa \sin \alpha H^{12} - \beta\kappa\tau \cos \alpha \frac{1}{4\delta} g^1 \\
 & + \beta\kappa \left( \kappa' \frac{1}{4\delta} g^1 + \kappa^2 \cos \alpha \frac{1}{2(2\delta + \beta)} (g^2 \cos \alpha + g^3 \sin \alpha) - \kappa^2 \sin \alpha \frac{1}{2(2\delta + \beta)} \right. \\
 & (g^3 \cos \alpha - g^2 \sin \alpha) \Big) - 2\beta\kappa \left( \frac{1}{4\delta} \frac{\partial g^1}{\partial x_1} - \kappa \left( \cos \alpha \frac{1}{2(2\delta + \beta)} (g^2 \cos \alpha + g^3 \sin \alpha) \right. \right. \\
 & \left. \left. - \frac{1}{2(2\delta + \beta)} (g^3 \cos \alpha - g^2 \sin \alpha) \sin \alpha \right) \right) \sin \alpha + \frac{\beta\kappa'}{2\delta} \sin \alpha g^1 - \beta\kappa\tau \cos \alpha \frac{1}{2\delta} g^1 \\
 & - \beta\kappa^2 \sin \alpha \left( - \cos \alpha \frac{1}{2\delta + \beta} (g^2 \cos \alpha + g^3 \sin \alpha) \right. \\
 & \left. + \sin \alpha \frac{1}{2\delta + \beta} (g^3 \cos \alpha - g^2 \sin \alpha) \right) \\
 & - 2\beta\kappa \sin \alpha \left( - \frac{1}{2\delta} \frac{\partial g^1}{\partial x_1} + \kappa \frac{1}{2\delta + \beta} \left( \cos \alpha (g^2 \cos \alpha + g^3 \sin \alpha) \right. \right. \\
 & \left. \left. + \sin \alpha (g^3 \cos \alpha - g^2 \sin \alpha) \right) \right) + \frac{a}{8\mu} H^1 + \frac{a}{2\delta + \beta} (g^3 \cos \alpha - g^2 \sin \alpha), \\
 C^{12}(x_1, t) = & - \frac{2}{2(2\delta + \beta)} \left( \frac{\partial g^3}{\partial t} \cos \alpha - \frac{\partial g^2}{\partial t} \sin \alpha \right) + \frac{\delta}{2(2\delta + \beta)} \left( \frac{\partial^2 g^3}{\partial x_1^2} \cos \alpha + \tau \frac{\partial g^3}{\partial x_1} \sin \alpha \right. \\
 & + \left( \tau' g^3 + \tau \frac{\partial g^3}{\partial x_1} \right) \sin \alpha - \tau^2 g^3 \cos \alpha - \frac{\partial^2 g^2}{\partial x_1^2} \sin \alpha + \tau \frac{\partial g^2}{\partial x_1} \cos \alpha \\
 & + \left( \tau' g^2 + \tau \frac{\partial g^2}{\partial x_1} \right) \cos \alpha + \tau^2 g^2 \sin \alpha \Big) + \delta\kappa \sin \alpha H^{12} - \delta\kappa \cos \alpha H^{11} \\
 & + \left( \cos \alpha \frac{\kappa\tau}{4} g^1 - \left( \frac{\kappa}{2} \frac{\partial g^1}{\partial x_1} + \frac{\kappa'}{4} g^1 - \frac{\kappa^2}{2(2\delta + \beta)} (g^2 \cos \alpha + g^3 \sin \alpha) \right) \sin \alpha \right) \\
 & + \frac{\beta}{8\mu} \frac{\partial H^4}{\partial x_1} - \beta\kappa \cos \alpha H^{10} + \beta\kappa \sin \alpha H^{12} + \beta\kappa\tau \cos \alpha \frac{1}{4\delta} g^1 \\
 & - \beta\kappa \left( \kappa' \frac{1}{4\delta} g^1 + \kappa^2 \cos \alpha \frac{1}{2(2\delta + \beta)} (g^2 \cos \alpha + g^3 \sin \alpha) \right. \\
 & \left. - \kappa^2 \sin \alpha \frac{1}{2(2\delta + \beta)} (g^3 \cos \alpha - g^2 \sin \alpha) \right) \\
 & + 2\beta\kappa \left( \frac{1}{4\delta} \frac{\partial g^1}{\partial x_1} - \kappa \left( \cos \alpha \frac{1}{2(2\delta + \beta)} (g^2 \cos \alpha + g^3 \sin \alpha) - \frac{1}{2(2\delta + \beta)} \sin \alpha \right. \right. \\
 & \left. \left. (g^3 \cos \alpha - g^2 \sin \alpha) \right) \right) \sin \alpha - \frac{a}{8\mu} H^1 - \frac{a}{2\delta + \beta} (g^3 \cos \alpha - g^2 \sin \alpha). \quad (C.11)
 \end{aligned}$$

The functions  $D^5(x_1, t), \dots, D^{12}(x_1, t)$  in the expressions (4.43) for the second and third component of the microrotation second-order corrector ( $W_2^2, W_2^3$ ) are given as follows:

$$\begin{aligned}
 D^5(x_1, t) &= \frac{(2\delta - \frac{12\beta^2}{12\delta+6\beta})D^7 + C^5 - \frac{3\beta C^{10}}{12\delta+6\beta}}{-14\delta - 12\beta + \frac{12\beta^2}{12\delta+6\beta}}, \quad D^6(x_1, t) = \frac{-4\beta(D^9 + D^{11}) - C^6}{12\delta + 6\beta}, \\
 D^7(x_1, t) &= \frac{(C^7 - \frac{3\beta C^{10}}{12\delta+6\beta})(-14\delta - 12\beta + \frac{12\beta^2}{12\delta+6\beta}) - (-2\delta - 2\beta + \frac{12\beta^2}{12\delta+6\beta})(C^5 - \frac{3\beta C^{10}}{12\delta+6\beta})}{(-2\delta - 2\beta + \frac{12\beta^2}{12\delta+6\beta})(2\delta - \frac{12\beta^2}{12\delta+6\beta}) + (-14\delta - 2\beta + \frac{12\beta^2}{12\delta+6\beta})^2}, \\
 D^8(x_1, t) &= \frac{2\delta(D^5 + D^7) + 2\beta D^5 + \beta D^{10} - C^8}{4\alpha + 2\beta}, \\
 D^9(x_1, t) &= \frac{C^9 - \frac{3\beta C^6}{12\delta+6\beta} + (2\delta + 2\beta - \frac{12\beta^2}{12\delta+6\beta})D^{11}}{-14\delta - 2\beta + \frac{12\beta^2}{12\delta+6\beta}}, \quad D^{10}(x_1, t) = \frac{-4\beta(D^5 + D^7) - C^{10}}{12\delta + 6\beta}, \\
 D^{11}(x_1, t) &= \frac{(C^{11} - \frac{3\beta C^6}{12\delta+6\beta})(-14\delta - 2\beta + \frac{12\beta^2}{12\delta+6\beta}) + (2\delta - \frac{12\beta^2}{12\delta+6\beta})(C^9 - \frac{3\beta C^6}{12\delta+6\beta})}{D_*^{11}}, \\
 D^{12}(x_1, t) &= \frac{2\delta(D^9 + D^{11}) + 2\beta D^{11} + \beta D^6 - C^{12}}{4\delta + 2\beta},
 \end{aligned} \tag{C.12}$$

where

$$\begin{aligned}
 D_*^{11}(x_1, t) &= \left(-2\delta + \frac{12\beta^2}{12\delta + 6\beta}\right) \left(2\delta + 2\beta - \frac{12\beta^2}{12\delta + 6\beta}\right) \\
 &\quad + \left(-14\delta - 12\beta + \frac{12\beta^2}{12\delta + 6\beta}\right) \left(-14\delta - 2\beta + \frac{12\beta^2}{12\delta + 6\beta}\right).
 \end{aligned}$$

## C.2 Boundary Layers

In the following, we write down the exponentially decreasing functions  $\Sigma, \Pi, \Theta$  and  $\Lambda$  appearing in the equations for the velocity, pressure and microrotation first and second order boundary layers correctors in Section 4.3.2 (see (4.49), (4.52), (4.55) and (4.56)).

### C.2.1 Boundary Layers for Velocity and Pressure

The function  $\Xi(x_1, t, \mathbf{J}, \mathbf{K}, j)$  appearing in the equation (4.49) is given as

$$\begin{aligned}
 \Xi(x_1, t, \mathbf{J}, \mathbf{K}, j) &= \mu \left( \kappa \cos \alpha \left( \frac{\partial J^1}{\partial y_2} - \frac{\partial J^2}{\partial y_1} \right) + \kappa \sin \alpha \left( \frac{\partial J^3}{\partial y_1} - \frac{\partial J^1}{\partial y_3} \right) + \kappa (e_\alpha \cdot y') \Delta J^1 \right. \\
 &\quad \left. - \kappa \left( \frac{\partial J^2}{\partial y_1} \cos \alpha - \frac{\partial J^3}{\partial y_1} \sin \alpha \right), -\kappa \cos \alpha \frac{\partial J^2}{\partial y_2} + \kappa \sin \alpha \frac{\partial J^2}{\partial y_3} + 2\kappa \cos \alpha \frac{\partial J^1}{\partial y_1} \right. \\
 &\quad \left. \kappa \sin \alpha \frac{\partial J^3}{\partial y_3} - \kappa \cos \alpha \frac{\partial J^3}{\partial y_2} - 2\kappa \sin \alpha \frac{\partial J^1}{\partial y_1} \right)
 \end{aligned}$$

$$- \left( \kappa(e_\alpha \cdot y') \frac{\partial j}{\partial y_1}, 0, 0 \right) + a \left( \frac{\partial K^3}{\partial y_2} - \frac{\partial K^2}{\partial y_3}, \frac{\partial K^1}{\partial y_3} - \frac{\partial K^3}{\partial y_1}, \frac{\partial K^2}{\partial y_1} - \frac{\partial K^1}{\partial y_2} \right), \quad (\text{C.13})$$

where  $\mathbf{J} = (J^1, J^2, J^3)$ ,  $\mathbf{K} = (K^1, K^2, K^3)$  are vector functions,  $j$  is a scalar function,  $x_1 \in [0, l]$  and  $t \in [0, T]$ .

The function  $\Pi(x_1, t, \mathbf{J}_0, \mathbf{J}_1, \mathbf{K}_0, \mathbf{K}_1, j_0, j_1)$  from the equation (4.52) reads:

$$\begin{aligned} \Pi(x_1, t, \mathbf{J}_0, \mathbf{J}_1, \mathbf{K}_0, \mathbf{K}_1, j_0, j_1) = & - \left( \frac{\partial J_0^1}{\partial t}, \frac{\partial J_0^2}{\partial t}, \frac{\partial J_0^3}{\partial t} \right) + \mu \left( \kappa \cos \alpha \left( \frac{\partial J_1^1}{\partial y_2} - \frac{\partial J_1^2}{\partial y_1} \right) \right. \\ & + \kappa \sin \alpha \left( \frac{\partial J_1^3}{\partial y_1} - \frac{\partial J_1^1}{\partial y_3} \right) - \left( \kappa \cos \alpha \frac{\partial J_1^2}{\partial y_1} - \kappa \sin \alpha \frac{\partial J_1^3}{\partial y_1} \right) \\ & - \left( J_0^2 (\kappa \cos \alpha)' - J_0^3 (\kappa \sin \alpha)' \right) - \kappa^2 J_0^1 \\ & + \kappa(e_\alpha \cdot y') \left( \Delta J_1^1 - \kappa \cos \alpha \frac{\partial J_0^1}{\partial y_2} + \kappa \sin \alpha \frac{\partial J_0^1}{\partial y_3} \right) \\ & + \kappa^2 (e_\alpha \cdot y')^2 \Delta J_0^1, -\kappa \cos \alpha \frac{\partial J_1^2}{\partial y_2} + \kappa \sin \alpha \frac{\partial J_1^2}{\partial y_3} \\ & + 2\kappa(e_\alpha \cdot y') \left( -\kappa \cos \alpha \frac{\partial J_0^2}{\partial y_2} + \kappa \sin \alpha \frac{\partial J_0^2}{\partial y_3} \right) \\ & + \left( 2\kappa \frac{\partial J_1^1}{\partial y_1} + \kappa' J_0^1 - \kappa^2 J_0^2 \right) \cos \alpha \\ & + \kappa \tau J_0^1 \sin \alpha + \kappa^2 \cos \alpha (e_\alpha \cdot y') \frac{\partial J_0^2}{\partial y_2} \\ & - \kappa^2 \sin \alpha (e_\alpha \cdot y') \frac{\partial J_0^2}{\partial y_3}, \kappa \sin \alpha \frac{\partial J_1^3}{\partial y_3} - \kappa \cos \alpha \frac{\partial J_1^3}{\partial y_2} \\ & + 2\kappa(e_\alpha \cdot y') \kappa \sin \alpha \frac{\partial J_0^3}{\partial y_3} \\ & - 2\kappa(e_\alpha \cdot y') \kappa \cos \alpha \frac{\partial J_0^3}{\partial y_2} + \kappa \tau J_0^1 \cos \alpha \\ & - \left( 2\kappa \frac{\partial J_1^1}{\partial y_1} + \kappa' J_0^1 - \kappa^2 J_0^2 \right) \sin \alpha + \kappa^2 \cos \alpha (e_\alpha \cdot y') \frac{\partial J_0^3}{\partial y_2} \\ & - \kappa^2 \sin \alpha (e_\alpha \cdot y') \frac{\partial J_0^3}{\partial y_3} \\ & - \left( \kappa(e_\alpha \cdot y') \frac{\partial j_1}{\partial y_1} + \kappa^2 (e_\alpha \cdot y')^2 \frac{\partial j_0}{\partial y_1}, 0, 0 \right) \\ & + a \left( \frac{\partial K_1^3}{\partial y_2} - \frac{\partial K_1^2}{\partial y_3}, \frac{\partial K_1^1}{\partial y_3} - \frac{\partial K_1^3}{\partial y_1} \right. \\ & + \kappa(e_\alpha \cdot y') \left( \frac{\partial K_0^1}{\partial y_3} - \frac{\partial K_0^3}{\partial y_1} \right), \frac{\partial K_1^2}{\partial y_1} - \frac{\partial K_1^1}{\partial y_2} \\ & \left. + \kappa(e_\alpha \cdot y') \left( \frac{\partial K_0^2}{\partial y_1} - \frac{\partial K_0^1}{\partial y_2} \right) \right), \quad (\text{C.14}) \end{aligned}$$



where  $\mathbf{J}_0 = (J_0^1, J_0^2, J_0^3)$ ,  $\mathbf{J}_1 = (J_1^1, J_1^2, J_1^3)$ ,  $\mathbf{K}_0 = (K_0^1, K_0^2, K_0^3)$ ,  $\mathbf{K}_1 = (K_1^1, K_1^2, K_1^3)$  are vector functions,  $j_0, j_1$  are scalar functions,  $x_1 \in [0, l]$  and  $t \in [0, T]$ .

## C.2.2 Boundary Layers for Microrotation

The function  $\Theta(x_1, t, \mathbf{J}, \mathbf{K})$  in the equation (4.55) takes the following form:

$$\begin{aligned}
 \Theta(x_1, t, \mathbf{J}, \mathbf{K}) = & \delta \left( \kappa \cos \alpha \left( \frac{\partial K^1}{\partial y_2} - \frac{\partial K^2}{\partial y_1} \right) + \kappa \sin \alpha \left( \frac{\partial K^3}{\partial y_1} - \frac{\partial K^1}{\partial y_3} \right) + \kappa (e_\alpha \cdot y') \Delta K^1 \right. \\
 & - \kappa \left( \frac{\partial K^2}{\partial y_1} \cos \alpha - \frac{\partial K^3}{\partial y_1} \sin \alpha \right), -\kappa \cos \alpha \frac{\partial K^2}{\partial y_2} + \kappa \sin \alpha \frac{\partial K^2}{\partial y_3} \\
 & + 2\kappa \cos \alpha \frac{\partial K^1}{\partial y_1}, \kappa \sin \alpha \frac{\partial K^3}{\partial y_3} - \kappa \cos \alpha \frac{\partial K^3}{\partial y_2} \\
 & - 2\kappa \sin \alpha \frac{\partial K^1}{\partial y_1} \left. \right) + \beta \left( -\kappa \cos \alpha \frac{\partial K^2}{\partial y_1} + \kappa \sin \alpha \frac{\partial K^3}{\partial y_1}, \right. \\
 & - \kappa \left( \frac{\partial K^2}{\partial y_2} \cos \alpha - \frac{\partial K^3}{\partial y_2} \sin \alpha \right) + 2\kappa \cos \alpha \frac{\partial K^1}{\partial y_1}, \\
 & - \kappa \left( \frac{\partial K^2}{\partial y_3} \cos \alpha - \frac{\partial K^3}{\partial y_3} \sin \alpha \right) - 2\kappa \sin \alpha \frac{\partial K^1}{\partial y_1} \left. \right) \\
 & + a \left( \frac{\partial J^3}{\partial y_2} - \frac{\partial J^2}{\partial y_3}, \frac{\partial J^1}{\partial y_3} - \frac{\partial J^3}{\partial y_1}, \frac{\partial J^2}{\partial y_1} - \frac{\partial J^1}{\partial y_2} \right),
 \end{aligned} \tag{C.15}$$

where  $\mathbf{J} = (J^1, J^2, J^3)$ ,  $\mathbf{K} = (K^1, K^2, K^3)$  are vector functions,  $x_1 \in [0, l]$  and  $t \in [0, T]$ .

The function  $\Lambda(x_1, t, \mathbf{J}_0, \mathbf{J}_1, \mathbf{K}_0, \mathbf{K}_1)$  from the equation (4.56) reads:

$$\begin{aligned}
 \Lambda(x_1, t, \mathbf{J}_0, \mathbf{J}_1, \mathbf{K}_0, \mathbf{K}_1) = & - \left( \frac{\partial K_0^1}{\partial t}, \frac{\partial K_0^2}{\partial t}, \frac{\partial K_0^3}{\partial t} \right) + \delta \left( \kappa \cos \alpha \left( \frac{\partial K_1^1}{\partial y_2} - \frac{\partial K_1^2}{\partial y_1} \right) \right. \\
 & + \kappa \sin \alpha \left( \frac{\partial K_1^3}{\partial y_1} - \frac{\partial K_1^1}{\partial y_3} \right) - \left( \kappa \cos \alpha \frac{\partial K_1^2}{\partial y_1} - \kappa \sin \alpha \frac{\partial K_1^3}{\partial y_1} \right) \\
 & - \kappa^2 K_0^2 - \left( K_0^2 (\kappa \cos \alpha)' - K_0^3 (\kappa \sin \alpha)' \right) \\
 & + \kappa (e_\alpha \cdot y') \left( \Delta K_1^1 - \kappa \cos \alpha \frac{\partial K_0^1}{\partial y_2} + \kappa \sin \alpha \frac{\partial K_0^1}{\partial y_3} \right) \\
 & + \kappa^2 (e_\alpha \cdot y')^2 \Delta K_0^1, -\kappa \cos \alpha \frac{\partial K_1^2}{\partial y_2} + \kappa \sin \alpha \frac{\partial K_1^2}{\partial y_3} \\
 & + 2\kappa (e_\alpha \cdot y') \left( -\kappa \cos \alpha \frac{\partial K_0^2}{\partial y_2} + \kappa \sin \alpha \frac{\partial K_0^2}{\partial y_3} \right) \\
 & + \left( 2\kappa \frac{\partial K_1^1}{\partial y_1} + \kappa' K_0^1 - \kappa^2 K_0^2 \right) \cos \alpha + \kappa \tau K_0^1 \sin \alpha \\
 & + \kappa^2 \cos \alpha (e_\alpha \cdot y') \frac{\partial K_0^2}{\partial y_2} - \kappa^2 \sin \alpha (e_\alpha \cdot y') \frac{\partial K_0^2}{\partial y_3}, \\
 & \kappa \sin \alpha \frac{\partial K_1^3}{\partial y_3} - \kappa \cos \alpha \frac{\partial K_1^3}{\partial y_2}
 \end{aligned}$$

$$\begin{aligned}
 & + 2\kappa(e_\alpha \cdot y')\kappa \sin \alpha \frac{\partial K_0^3}{\partial y_3} - 2\kappa(e_\alpha \cdot y')\kappa \cos \alpha \frac{\partial K_0^3}{\partial y_2} \\
 & + \kappa\tau K_0^1 \cos \alpha - \left( 2\kappa \frac{\partial K_1^1}{\partial y_1} + \kappa' K_0^1 - \kappa^2 K_0^2 \right) \sin \alpha \\
 & + \kappa^2 \cos \alpha (e_\alpha \cdot y') \frac{\partial K_0^3}{\partial y_2} - \kappa^2 \sin \alpha (e_\alpha \cdot y') \frac{\partial K_0^3}{\partial y_3} \\
 & + \beta \left( -(\kappa \cos \alpha)' K_0^2 - \kappa \cos \alpha \frac{\partial K_1^2}{\partial y_1} + (\kappa \sin \alpha)' K_0^3 + \kappa \sin \alpha \frac{\partial K_1^3}{\partial y_1} \right. \\
 & + \kappa(e_\alpha \cdot y') \left( -\kappa \cos \alpha \frac{\partial K_0^2}{\partial y_1} + \kappa \sin \alpha \frac{\partial K_0^3}{\partial y_1} \right), -\kappa \left( \frac{\partial K_1^2}{\partial y_2} \cos \alpha \right. \\
 & \left. - \frac{\partial K_1^3}{\partial y_2} \sin \alpha \right) + \left( \kappa' K_0^1 + \kappa^2 K_0^2 - \kappa^2 \sin \alpha K_0^3 + 2\kappa \left( \frac{\partial K_1^1}{\partial y_1} \right. \right. \\
 & \left. \left. - \kappa \left( K_0^2 \cos \alpha - K_0^3 \sin \alpha \right) \right) \right) \cos \alpha + \kappa\tau K_0^1 \sin \alpha \\
 & + \kappa'(e_\alpha \cdot y') \frac{\partial K_1^1}{\partial y_2} + \kappa\tau(e_\alpha^\perp \cdot y') \frac{\partial K_1^1}{\partial y_2} + \kappa^2(e_\alpha \cdot y') \frac{\partial K_0^2}{\partial y_2} \cos \alpha \\
 & - \kappa^2(e_\alpha \cdot y') \frac{\partial K_0^3}{\partial y_2} \sin \alpha + 2\kappa(e_\alpha \cdot y') \left( \frac{\partial^2 K_1^1}{\partial y_1 \partial y_2} - \kappa \left( \frac{\partial K_0^2}{\partial y_2} \cos \alpha \right. \right. \\
 & \left. \left. - \frac{\partial K_0^3}{\partial y_2} \sin \alpha \right) \right), -\kappa \left( \frac{\partial K_1^2}{\partial y_3} \cos \alpha - \frac{\partial K_1^3}{\partial y_3} \sin \alpha \right) + \kappa\tau K_0^1 \cos \alpha \\
 & - \left( \kappa' K_0^1 + \kappa^2 \cos \alpha K_0^2 - \kappa^2 \sin \alpha K_0^3 + 2\kappa \left( \frac{\partial K_1^1}{\partial y_1} \right. \right. \\
 & \left. \left. - \kappa \left( K_0^2 \cos \alpha - K_0^3 \sin \alpha \right) \right) \right) \sin \alpha + \kappa'(e_\alpha \cdot y') \frac{\partial K_0^1}{\partial y_3} \\
 & + \kappa\tau(e_\alpha^\perp \cdot y') \frac{\partial K_0^1}{\partial y_3} + \kappa^2(e_\alpha \cdot y') \left( \cos \alpha \frac{\partial K_0^2}{\partial y_3} - \sin \alpha \frac{\partial K_0^3}{\partial y_3} \right) \\
 & + 2\kappa(e_\alpha \cdot y') \frac{\partial^2 K_1^1}{\partial y_1 \partial y_3} - 2\kappa^2(e_\alpha \cdot y') \left( \frac{\partial K_0^2}{\partial y_3} \cos \alpha - \frac{\partial K_0^3}{\partial y_3} \sin \alpha \right) \\
 & - 2a \left( K_0^1, K_0^2, K_0^3 \right) + a \left( \frac{\partial J_1^3}{\partial y_2} - \frac{\partial J_1^2}{\partial y_3}, \frac{\partial J_1^1}{\partial y_3} - \frac{\partial J_1^3}{\partial y_1} \right. \\
 & + \kappa(e_\alpha \cdot y') \left( \frac{\partial J_0^1}{\partial y_3} - \frac{\partial J_0^3}{\partial y_1} \right), \frac{\partial J_1^2}{\partial y_1} - \frac{\partial J_1^1}{\partial y_2} \\
 & \left. + \kappa(e_\alpha \cdot y') \left( \frac{\partial J_0^2}{\partial y_1} - \frac{\partial J_0^1}{\partial y_2} \right) \right), \tag{C.16}
 \end{aligned}$$

where  $\mathbf{J}_0 = (J_0^1, J_0^2, J_0^3)$ ,  $\mathbf{J}_1 = (J_1^1, J_1^2, J_1^3)$ ,  $\mathbf{K}_0 = (K_0^1, K_0^2, K_0^3)$ ,  $\mathbf{K}_1 = (K_1^1, K_1^2, K_1^3)$  are vector functions,  $x_1 \in [0, l]$  and  $t \in [0, T]$ .



# Bibliography

- [1] A. Adams and J. F. Fournier. *Sobolev Spaces*. Pure and Applied Mathematics 140, Academic Press, 1992.
- [2] I. Aganović. *An Introduction to Boundary Value Problems in Continuum Mechanics*. Element, Zagreb, 2003.
- [3] T. Ameel, A. B. Frazier, I. Papautsky, and J. Brazzle. *Laminar fluid behaviour in microchannels using micropolar fluid theory*. Sens. Actuators A Phys. 73 (1999), 101-108.
- [4] M. Beneš and P. Kučera. *Solutions to the Navier–Stokes equations with mixed boundary conditions in two–dimensional bounded domains*. Math. Nachr. 289 (2016), 194-212.
- [5] M. Beneš, I. Pažanin, and M. Radulović. *Existence and uniqueness of the generalized Poiseuille solution for nonstationary micropolar flow in an infinite cylinder*. Electron. J. Differ. Eq. 148 (2018), issn:1072-6691, 1-26.
- [6] M. Beneš, I. Pažanin, and M. Radulović. *Rigorous derivation of the asymptotic model describing a nonsteady micropolar fluid flow through a thin pipe*. Comput. Math. Appl. 76 (9) (2018), 2035-2060.
- [7] J. L. Boldrini, M. Duran, and M. A. Rojas-Medar. *Existence and uniqueness of strong solution for the incompressible micropolar fluid equations in domains of  $\mathbb{R}^3$* . Ann. Univ. Ferrara 56 (2010), 37-51.
- [8] G. Castineira, E. Marušić-Paloka, I. Pažanin, and J. M. Rodriguez. *Rigorous justification of the asymptotic model describing a curved-pipe flow in a time-dependent domain*. Z. Angew. Math. Mech. 99 (1) (2018), 1-39.
- [9] G. Castineira and J. M. Rodriguez. *Asymptotic Analysis of a Viscous Flow in a Curved Pipe with Elastic Walls*. Trends in Differential Equations and Applications (2016), doi:10.1007/978-3-319-32013-75, 73-87.
- [10] D. Dupuy, G. Panasenko, and R. Stavre. *Asymptotic methods for micropolar fluids in a tube structure*. Math. Models Methods Appl. Sci. 14 (2004), 735-758.

- [11] D. Dupuy, G. Panasenko, and R. Stavre. *Asymptotic Solution for a Micropolar Flow in a Curvilinear Channel*. Z. Angew. Math. Mech. 88 (2008), 793-807.
- [12] A. C. Eringen. *Theory of Micropolar Fluids*. J. Appl. Math. Mech. 16 (1966), 1-18.
- [13] L. Evans. *Partial Differential Equations*. AMS, Providence, 1998.
- [14] G. P. Galdi. *An Introduction to the Mathematical Theory of the Navier-Stokes equations, vol. I*. Springer, Berlin, 1994.
- [15] M. Germano. *On the effect of torsion on a helical pipe flow*. J. Fluid Mech. 125 (1982), 1-8.
- [16] M. Germano. *The Dean equations extended to a helical pipe flow*. J. Fluid Mech. 203 (1989), 289-305.
- [17] A. Kufner, O. John, and S. Fučík. *Function Spaces*. Academia, 1977.
- [18] O. A. Ladyzhenskaya. *The Boundary Value Problems of Mathematical Physics*. Springer-Verlag, New York, 1985.
- [19] T. Levi-Civita. *The Absolute Differential Calculus*. Blackie and Son, London and Glasgow, 1927.
- [20] J. L. Lions and E. Magenes. *Non-Homogeneous Boundary Value Problems and Applications*. Springer-Verlag, Berlin, I and II edition, 1972.
- [21] G. Lukaszewicz. *Long time behaviour of 2D micropolar fluid flows*. Math. Comput. Model. 34 (2001), 487-509.
- [22] G. Lukaszewicz. *Micropolar fluids: Theory and Applications*. Birkhäuser, Boston, 2nd edition, 1999.
- [23] K.P. Madasu and M. K. Gurdatta. *Steady Rotation of Micropolar Fluid Sphere in Concentric Spherical Container*. Procedia Eng. 127 (2015), 469-475.
- [24] E. Marušić-Paloka. *The Effects of Flexion and Torsion on a Fluid Flow Through a Curved Pipe*. Appl. Math. Optim. 44 (2001), 245-272.
- [25] G. Panasenko and K. Pileckas. *Asymptotic analysis of the non-steady Navier-Stokes equations in a tube structure. I. The case without boundary layer-in-time*. Nonlinear Anal-Theor 122 (2015), 125-168.
- [26] G. Panasenko and K. Pileckas. *Asymptotic analysis of the non-steady Navier-Stokes equations in a tube structure. II. General case*. Nonlinear Anal-Theor 125 (2015), 582-607.

- 
- [27] G. Panasenko and K. Pileckas. *Asymptotic analysis of the nonsteady viscous flow with a given flow rate in a thin pipe*. Appl. Anal. 91 (2012), 559-574.
- [28] I. Pažanin. *Asymptotic Behaviour of Micropolar Fluid Flow Through a Curved Pipe*. Acta Appl. Math. 116 (2011), 1-25.
- [29] I. Pažanin. *Effective flow of Micropolar Fluid through a Thin or Long Pipe*. Math. Probl. Eng. 2011 (2011), doi:10.1155/2011/127070, 1-18.
- [30] I. Pažanin and M. Radulović. *Asymptotic analysis of the nonsteady micropolar fluid flow through a curved pipe*. Appl. Anal. (2018), doi:10.1080/00036811.2018.1553036, 1-48.
- [31] I. Pažanin and M. Radulović. *Asymptotic approximation of the nonsteady micropolar fluid flow through a circular pipe*. Math. Probl. Eng. 2018 (2018), doi:10.1155/2018/6759876, 1-16.
- [32] K. Pileckas. *Existence of Solutions with the Prescribed Flux of the Navier-Stokes System in an Infinite Cylinder*. J. Math. Fluid Mech. 8 (2006), 542-563.
- [33] K. Pileckas. *Navier-Stokes system in domains with cylindrical outlets to infinity. Leray's problem*. Handbook of Mathematical Fluid Dynamics 4 (2007), 445-667.
- [34] K. Pileckas. *On the behavior of a nonstationary Poiseuille solution as  $t \rightarrow \infty$* . Sib. Math. J. 46 (2005), 707-716.
- [35] K. Pileckas and V. Keblikas. *Existence of a nonstationary Poiseuille solution*. Sib. Math. J. 46 (2005), 514-526.
- [36] T. Roubiček. *Nonlinear Partial Differential Equations with Applications*. Birkhäuser, 2005.
- [37] V. A. Sava. *The Initial-Boundary-Value Problems in the Theory of Micropolar Fluids*. Z. Angew. Math. Mech. 56 (1978), 511-518.
- [38] F. V. Silva. *Leray's problem for a viscous incompressible micropolar fluid*. J. Math. Anal. Appl. 306 (2005), 692-713.
- [39] P. Szopa. *On existence and regularity of solutions for 2-D micropolar fluid equations with periodic boundary conditions*. Math. Method Appl. Sci. 30 (2007), 331-346.
- [40] R. Temam. *Navier-Stokes Equations: Theory and Numerical Analysis*. North-Holland Publishing edition, Company, Amsterdam, New York, Oxford. Revis, 1979.



# Curriculum Vitae

Marko Radulović was born on 14th of July 1990 in Zagreb, Croatia. He received his primary and secondary education in Zagreb. In 2014, he graduated at the Department of Mathematics, Faculty of Science, University of Zagreb, with the thesis title *Mathematical formulations of the uncertainty principle*, under the supervision of prof. Vjekoslav Kovač.

He worked as a teacher of mathematics from 2014 to 2015 at the Second gymnasium in Zagreb. In 2015, he enrolled in the doctoral program in mathematics at the Department of Mathematics under the supervision of prof. Igor Pažanin and became a member of the *Seminar for differential equations and numerical analysis*. In 2016, he started working as a research and teaching assistant at the Department of Mathematics, Faculty of Science, University of Zagreb, within the project *Mathematical modeling and numerical simulations of processes in thin or porous domains* (PI: prof. Eduard Marušić–Paloka) financed by the Croatian Science Foundation (3955, 2014–2018). He is currently a member of the project *Asymptotic analysis of boundary value problems in continuum mechanics* (PI: prof. Eduard Marušić–Paloka) financed by the Croatian Science Foundation (2735, 2018–2022).

He was a teaching assistant for several courses including *Applied mathematical analysis*, *Ordinary differential equations*, *Fundamentals of mathematical analysis* and *Fundamentals of algorithms*.

He attended a number of conferences and workshops, where he gave three talks and one poster presentation. He had two short scientific visits during which he gave one seminar talk. He co-authored nine papers, six of which are published:

1. E. Marušić-Paloka, I. Pažanin, and M. Radulović. *Flow of a micropolar fluid through a channel with small boundary perturbation*. Z. Naturforsch. A 71 (7) (2016), 607-619.
2. U. S. Mahabaleshwar, I. Pažanin, M. Radulović, and F. J. Suárez–Grau. *Effects of small boundary perturbation on the MHD duct flow*. Theor. Appl. Mech. 44 (1) (2017), 83-101.
3. I. Pažanin and M. Radulović. *Asymptotic approximation of the nonsteady micropolar fluid flow through a circular pipe*. Math. Probl. Eng. 2018 (2018), doi:10.1155/2018/6759876, 1-16.



4. M. Beneš, I. Pažanin, and M. Radulović. *Existence and uniqueness of the generalized Poiseuille solution for nonstationary micropolar flow in an infinite cylinder*. Electron. J. Differ. Eq. 148 (2018), issn:1072-6691, 1-26.
5. M. Beneš, I. Pažanin, and M. Radulović. *Rigorous derivation of the asymptotic model describing a nonsteady micropolar fluid flow through a thin pipe*. Comput. Math. Appl. 76 (9) (2018), 2035-2060.
6. I. Pažanin and M. Radulović. *Asymptotic analysis of the nonsteady micropolar fluid flow through a curved pipe*. Appl. Anal. (2018), doi:10.1080/00036811.2018.1553036, 1-48.