

# TeV-scale seesaw mechanism with quintuplet fermions

---

**Kumerički, Krešimir; Picek, Ivica; Radovčić, Branimir**

*Source / Izvornik:* **Physical Review D - Particles, Fields, Gravitation and Cosmology, 2012, 86**

**Journal article, Published version**

**Rad u časopisu, Objavljena verzija rada (izdavačev PDF)**

<https://doi.org/10.1103/PhysRevD.86.013006>

*Permanent link / Trajna poveznica:* <https://um.nsk.hr/um:nbn:hr:217:141911>

*Rights / Prava:* [In copyright](#)/[Zaštićeno autorskim pravom.](#)

*Download date / Datum preuzimanja:* **2025-01-10**



*Repository / Repozitorij:*

[Repository of the Faculty of Science - University of Zagreb](#)



# TeV-scale seesaw mechanism with quintuplet fermions

Krešimir Kumerički, Ivica Picek, and Branimir Radovčić

*Department of Physics, Faculty of Science, University of Zagreb, P.O.B. 331, HR-10002 Zagreb, Croatia*

(Received 4 May 2012; published 6 July 2012)

We propose a new seesaw model based on a fermionic hypercharge-zero weak quintuplet in conjunction with an additional scalar quadruplet which attains an induced vacuum expectation value. The model provides both tree-level seesaw  $\sim v^6/M^5$  and loop-suppressed radiative  $\sim (1/16\pi^2) \cdot v^2/M$  contributions to active neutrino masses. The empirical masses  $m_\nu \sim 10^{-1}$  eV can be achieved with  $M \sim \text{TeV}$  new states, accessible at the LHC. For  $5 \text{ fb}^{-1}$  of accumulated integrated luminosity at the LHC, there could be  $\sim 500$  doubly-charged  $\Sigma^{++}$  or  $\bar{\Sigma}^{++}$  fermions with mass  $M_\Sigma = 400 \text{ GeV}$ , leading to interesting multi-lepton signatures. The neutral component of the fermion quintuplet, previously identified as a minimal dark matter candidate, becomes unstable in the proposed seesaw setup. The stability can be restored by introducing a  $Z_2$  symmetry, in which case neutrinos get mass only from radiative contributions.

DOI: [10.1103/PhysRevD.86.013006](https://doi.org/10.1103/PhysRevD.86.013006)

PACS numbers: 14.60.Pq, 14.60.St, 95.35.+d

## I. INTRODUCTION

We propose a seesaw model built upon the hypercharge-zero fermionic weak quintuplet which, in isolation, provides a viable dark matter (DM) particle within the so-called minimal dark matter (MDM) model [1]. We explore the conditions under which the quintuplets  $\Sigma_R \sim (1, 5, 0)$  could simultaneously generate the masses of the known neutrinos and provide a stable DM candidate.

The proposed model goes beyond the three tree-level realizations of Weinberg's effective dimension-five operator  $LLHH$  [2]: type I [3], type II [4], and type III [5] seesaw mechanisms, mediated by a heavy fermion singlet, a scalar triplet, and a fermion triplet, respectively. A seesaw mediator of isospin larger than one has to be accompanied by a scalar multiplet larger than that of the standard model (SM) Higgs doublet.

Our previous model [6,7], based on an exotic nonzero hypercharge weak quintuplet Dirac fermion  $\Sigma_R \sim (1, 5, 2)$ , generates the neutrino masses both at the tree level and at the loop level. At the tree level it corresponds to dimension-nine seesaw operator which reproduces the empirical neutrino masses  $m_\nu \sim 10^{-1}$  eV with  $M_\Sigma \sim \text{few } 100 \text{ GeV}$  states testable at the LHC, while for heavier masses, which are outside of the LHC reach, these exotic leptons generate radiative neutrino masses. However, if one expects from new states to accomplish simultaneously the DM mission, they should have zero hypercharge.

A recent "R $\nu$ MDM model" [8] of purely radiative neutrino (R $\nu$ ) masses employs hypercharge-zero quintuplets  $\Sigma_R \sim (1, 5, 0)$  which, taken in isolation, provide a viable MDM candidate [1]. In a separate paper [9] we identify an omitted term in [8] which spoils the claimed DM stability. Therefore, we adopt here a more general approach in which we analyze in detail both the tree-level and the radiative neutrino masses generated by hypercharge-zero quintuplets  $\Sigma_R \sim (1, 5, 0)$ . Thereby we address also the phenomenology of these states at the LHC

and recall that by imposing a  $Z_2$  symmetry, one can reconcile the seesaw mission with the viability as a DM.

## II. THE MODEL WITH FERMIONIC QUINTUPLETS

As announced above, the model we propose here is based on the symmetry of the SM gauge group  $SU(3)_C \times SU(2)_L \times U(1)_Y$ . In addition to usual SM fermions, we introduce three generations of hypercharge-zero quintuplets  $\Sigma_R = (\Sigma_R^{++}, \Sigma_R^+, \Sigma_R^0, \Sigma_R^-, \Sigma_R^{--})$ , transforming as  $(1, 5, 0)$  under the gauge group. Also, in addition to the SM Higgs doublet  $H = (H^+, H^0)$  there is a scalar quadruplet  $\Phi = (\Phi^+, \Phi^0, \Phi^-, \Phi^{--})$  transforming as  $(1, 4, -1)$ .

This is in contrast to a recent model for radiative neutrino masses [8] adopted subsequently in [10], where a use of the scalar sextuplet  $\Phi \sim (1, 6, -1)$  avoids the tree-level contribution. In a tensor notation suitable to cope with higher  $SU(2)_L$  multiplets [8] our additional fields are totally symmetric tensors  $\Sigma_{Rijkl}$  and  $\Phi_{ijk}$  with the following components:

$$\begin{aligned} \Sigma_{R1111} &= \Sigma_R^{++}, & \Sigma_{R1112} &= \frac{1}{\sqrt{4}} \Sigma_R^+, \\ \Sigma_{R1122} &= \frac{1}{\sqrt{6}} \Sigma_R^0, & \Sigma_{R1222} &= \frac{1}{\sqrt{4}} \Sigma_R^-, \\ \Sigma_{R2222} &= \Sigma_R^{--}; \end{aligned} \quad (1)$$

$$\begin{aligned} \Phi_{111} &= \Phi^+, & \Phi_{112} &= \frac{1}{\sqrt{3}} \Phi^0, \\ \Phi_{122} &= \frac{1}{\sqrt{3}} \Phi^-, & \Phi_{222} &= \Phi^{--}. \end{aligned} \quad (2)$$

The gauge-invariant and renormalizable Lagrangian involving these new fields reads

$$\begin{aligned} \mathcal{L} = & \overline{\Sigma}_R i \gamma^\mu D_\mu \Sigma_R + (D_\mu \Phi)^\dagger (D_\mu \Phi) \\ & - \left( \overline{L}_L Y \Phi \Sigma_R + \frac{1}{2} \overline{(\Sigma_R)^C} M \Sigma_R + \text{H.c.} \right) - V(H, \Phi). \end{aligned} \quad (3)$$

Here,  $D_\mu$  is the gauge-covariant derivative,  $Y$  is the Yukawa-coupling matrix, and  $M$  is the mass matrix of the heavy leptons, which we choose to be real and diagonal. For simplicity, we drop the flavor indices altogether.

The scalar potential has the gauge-invariant form

$$\begin{aligned} V(H, \Phi) = & -\mu_H^2 H^\dagger H + \mu_\Phi^2 \Phi^\dagger \Phi + \lambda_1 (H^\dagger H)^2 \\ & + \lambda_2 H^\dagger H \Phi^\dagger \Phi + \lambda_3 H^* H \Phi^* \Phi \\ & + (\lambda_4 H^* H H \Phi + \text{H.c.}) + (\lambda_5 H H \Phi \Phi + \text{H.c.}) \\ & + (\lambda_6 H \Phi^* \Phi \Phi + \text{H.c.}) + \lambda_7 (\Phi^\dagger \Phi)^2 \\ & + \lambda_8 \Phi^* \Phi \Phi^* \Phi. \end{aligned} \quad (4)$$

In the adopted tensor notation the terms in Eqs. (3) and (4) read

$$\begin{aligned} \overline{L}_L \Phi \Sigma_R &= \overline{L}_L^i \Phi_{jkl} \Sigma_{Ri'j'k'l'} \epsilon^{ij'} \epsilon^{kk'} \epsilon^{ll'}, \\ \overline{(\Sigma_R)^C} \Sigma_R &= \overline{(\Sigma_R)^C}_{ijkl} \Sigma_{Ri'j'k'l'} \epsilon^{ij'} \epsilon^{kk'} \epsilon^{ll'}, \\ H^* H \Phi^* \Phi &= H^{*i} H_j \Phi^{*jkl} \Phi_{ikl}, \\ H^* H H \Phi &= H^{*i} H_j H_k \Phi_{ij'k'} \epsilon^{jj'} \epsilon^{kk'}, \\ H H \Phi \Phi &= H_i \Phi_{jkl} H_{i'} \Phi_{j'k'l'} \epsilon^{ij} \epsilon^{i'j'} \epsilon^{kk'} \epsilon^{ll'}, \\ H \Phi^* \Phi \Phi &= H_i \Phi^{*ijk} \Phi_{jlm} \Phi_{kl'm'} \epsilon^{ll'} \epsilon^{mm'}, \\ \Phi^* \Phi \Phi^* \Phi &= \Phi^{*ijk} \Phi_{i'jk} \Phi^{*i'j'k'} \Phi_{ij'k'}. \end{aligned} \quad (5)$$

Accordingly, the Majorana mass term for the quintuplet  $\Sigma_R$  is expanded in component fields to give

$$\begin{aligned} \overline{(\Sigma_R)^C} M \Sigma_R &= \overline{(\Sigma_R^{++})^C} M \Sigma_R^{--} - \overline{(\Sigma_R^+)^C} M \Sigma_R^- \\ &+ \overline{(\Sigma_R^0)^C} M \Sigma_R^0 - \overline{(\Sigma_R^-)^C} M \Sigma_R^+ \\ &+ \overline{(\Sigma_R^{--})^C} M \Sigma_R^{++}, \end{aligned} \quad (6)$$

the terms containing two charged Dirac fermions and one neutral Majorana fermion

$$\begin{aligned} \Sigma^{++} &= \Sigma_R^{++} + \Sigma_R^{--C}, & \Sigma^+ &= \Sigma_R^+ - \Sigma_R^{-C}, \\ \Sigma^0 &= \Sigma_R^0 + \Sigma_R^{0C}. \end{aligned} \quad (7)$$

The electroweak symmetry breaking proceeds in the usual way from the vacuum expectation value (VEV)  $v$  of the Higgs doublet, corresponding to the negative sign in front of the  $\mu_H^2$  term in Eq. (4). On the other hand, the electroweak  $\rho$  parameter dictates a small value for the VEV  $v_\Phi$  of the scalar quadruplet, implying the positive sign in front of the  $\mu_\Phi^2$  term. However, the presence of the  $\lambda_4$  term in Eq. (4), given explicitly by

$$\begin{aligned} H^* H H \Phi &= \frac{1}{\sqrt{3}} H^{*+} H^+ H^+ \Phi^- - \frac{2}{\sqrt{3}} H^{0*} H^+ H^0 \Phi^- \\ &+ H^{0*} H^+ H^+ \Phi^{--} + H^{*+} H^0 H^0 \Phi^+ \\ &- \frac{2}{\sqrt{3}} H^{*+} H^+ H^0 \Phi^0 + \frac{1}{\sqrt{3}} H^{0*} H^0 H^0 \Phi^0, \end{aligned} \quad (8)$$

leads to the induced VEV for the  $\Phi^0$  field,

$$v_\Phi \simeq -\frac{1}{\sqrt{3}} \lambda_4^* \frac{v^3}{\mu_\Phi^2}. \quad (9)$$

Since it changes the electroweak  $\rho$  parameter from the unit value to  $\rho \simeq 1 + 6v_\Phi^2/v^2$ , a comparison to the experimental value  $\rho = 1.0008_{-0.0007}^{+0.0017}$  [11] gives us a constraint  $v_\Phi \lesssim 3.6$  GeV.

### III. NEUTRINO MASSES

The Yukawa interaction terms from Eq. (3), when expressed like that in Eq. (5), read explicitly as

$$\begin{aligned} \overline{L}_L \Phi \Sigma_R &= -\frac{\sqrt{3}}{2} \bar{\nu}_L \Phi^- \Sigma_R^+ - \frac{1}{\sqrt{2}} \bar{l}_L \Phi^- \Sigma_R^0 + \frac{\sqrt{3}}{2} \bar{l}_L \Phi^0 \Sigma_R^- \\ &+ \frac{1}{\sqrt{2}} \bar{\nu}_L \Phi^0 \Sigma_R^0 - \frac{1}{2} \bar{\nu}_L \Phi^+ \Sigma_R^- - \bar{l}_L \Phi^+ \Sigma_R^- \\ &+ \frac{1}{2} \bar{l}_L \Phi^{--} \Sigma_R^+ + \bar{\nu}_L \Phi^{--} \Sigma_R^{++}. \end{aligned} \quad (10)$$

The VEV  $v_\Phi$  generates a Dirac mass term connecting  $\nu_L$  and  $\Sigma_R^0$ , a nondiagonal entry in the mass matrix for neutral leptons given by

$$\mathcal{L}_{\nu\Sigma^0} = -\frac{1}{2} (\bar{\nu}_L \overline{(\Sigma_R^0)^C}) \begin{pmatrix} 0 & \frac{1}{\sqrt{2}} Y v_\Phi \\ \frac{1}{\sqrt{2}} Y^T v_\Phi & M \end{pmatrix} \begin{pmatrix} (\nu_L)^c \\ \Sigma_R^0 \end{pmatrix} + \text{H.c.} \quad (11)$$

A similar term connecting light and heavy charged leptons gives the mass matrix for charged leptons

$$\mathcal{L}_{l\Sigma^-} = -(\bar{l}_L \overline{(\Sigma_R^+)^C}) \begin{pmatrix} Y_l v & -\frac{\sqrt{3}}{2} Y v_\Phi \\ 0 & M \end{pmatrix} \begin{pmatrix} l_R \\ (\Sigma_L^+)^c \end{pmatrix} + \text{H.c.} \quad (12)$$

After diagonalizing the mass matrix for the neutral leptons, the light neutrinos acquire the Majorana mass matrix given by

$$m_\nu^{\text{tree}} = -\frac{1}{2} v_\Phi^2 Y M^{-1} Y^T. \quad (13)$$

In the basis where the matrix of heavy leptons is real and diagonal,  $M = \text{diag}(M_1, M_2, M_3)$ , we can write  $m_\nu^{\text{tree}}$  as

$$(m_\nu)_{ij}^{\text{tree}} = -\frac{1}{2} v_\Phi^2 \sum_k \frac{Y_{ik} Y_{jk}}{M_k}. \quad (14)$$

Together with the induced VEV in Eq. (9), this gives

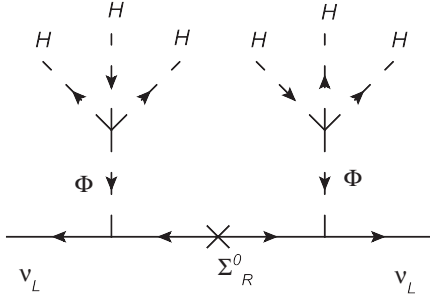

FIG. 1. Tree-level diagram corresponding to dimension-nine operator in Eq. (15). The fermion line flow indicates a Majorana nature of the seesaw mediator.

$$(m_\nu)_{ij}^{\text{tree}} = -\frac{1}{6}(\lambda_4^*)^2 \frac{v^6}{\mu_\Phi^4} \sum_k \frac{Y_{ik} Y_{jk}}{M_k}, \quad (15)$$

which reflects the fact that the light neutrino mass is generated from the dimension-nine operator corresponding to the tree-level seesaw mechanism displayed on Fig. 1.

Besides at the tree level, the light neutrino masses arise also through one-loop diagrams displayed on Fig. 2. The crucial quartic  $\lambda_5$  term in Eq. (4), which, expanded in component fields gives

$$\begin{aligned} HH\Phi\Phi &= \frac{2}{\sqrt{3}}\Phi^-\Phi^+H^0H^0 - \frac{2}{3}\Phi^-\Phi^-H^+H^+ \\ &+ \frac{2}{\sqrt{3}}\Phi^{--}\Phi^0H^+H^+ - \frac{2}{3}\Phi^0\Phi^0H^0H^0 \\ &+ \frac{2}{3}\Phi^-\Phi^0H^+H^0 - 2\Phi^+\Phi^{--}H^+H^0. \end{aligned} \quad (16)$$

There are two different contributions on Fig. 2, one with heavy neutral fields ( $\Sigma^0$ ,  $\Phi^0$ ) and the other with heavy charged fields ( $\Sigma^\pm$ ,  $\Phi^\pm$ ) running in the loop. If we neglect the mass splitting within the  $\Sigma$  and  $\Phi$  multiplets, the contribution to the light neutrino mass matrix is given by

$$(m_\nu)_{ij}^{\text{loop}} = \frac{-5\lambda_5^* v^2}{24\pi^2} \sum_k \frac{Y_{ik} Y_{jk} M_k}{m_\Phi^2 - M_k^2} \left[ 1 - \frac{M_k^2}{m_\Phi^2 - M_k^2} \ln \frac{m_\Phi^2}{M_k^2} \right]. \quad (17)$$

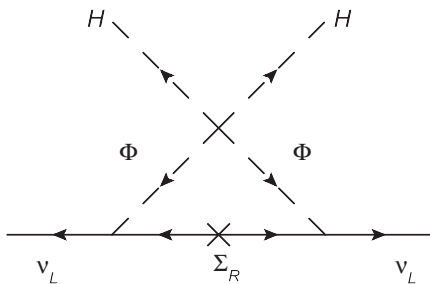

FIG. 2. One-loop diagrams generating the light neutrino masses.

This expression can be further specified [12], depending on relative values of the masses for additional fermion and scalar multiplets. For heavy fermions significantly heavier than the new scalars,  $M_k^2 \gg m_\Phi^2$ ,

$$(m_\nu)_{ij}^{\text{loop}} = \frac{-5\lambda_5^* v^2}{24\pi^2} \sum_k \frac{Y_{ik} Y_{jk}}{M_k} \left[ \ln \frac{M_k^2}{m_\Phi^2} - 1 \right]. \quad (18)$$

In the opposite case, for  $m_\Phi^2 \gg M_k^2$ ,

$$(m_\nu)_{ij}^{\text{loop}} = \frac{-5\lambda_5^* v^2}{24\pi^2 m_\Phi^2} \sum_k Y_{ik} Y_{jk} M_k. \quad (19)$$

Finally, if  $m_\Phi^2 \approx M_k^2$ , then

$$(m_\nu)_{ij}^{\text{loop}} = \frac{-5\lambda_5^* v^2}{48\pi^2} \sum_k \frac{Y_{ik} Y_{jk}}{M_k}. \quad (20)$$

The tree-level and the loop contributions added together give the light neutrino mass matrix

$$\begin{aligned} (m_\nu)_{ij} &= (m_\nu)_{ij}^{\text{tree}} + (m_\nu)_{ij}^{\text{loop}} \\ &= \frac{-1}{6}(\lambda_4^*)^2 \frac{v^6}{\mu_\Phi^4} \sum_k \frac{Y_{ik} Y_{jk}}{M_k} + \frac{-5\lambda_5^* v^2}{24\pi^2} \sum_k \frac{Y_{ik} Y_{jk} M_k}{m_\Phi^2 - M_k^2} \\ &\times \left[ 1 - \frac{M_k^2}{m_\Phi^2 - M_k^2} \ln \frac{m_\Phi^2}{M_k^2} \right]. \end{aligned} \quad (21)$$

In the case of comparable masses the light neutrino mass matrix reads

$$(m_\nu)_{ij} = \left[ \frac{-1}{6}(\lambda_4^*)^2 \frac{v^6}{\mu_\Phi^4} + \frac{-5\lambda_5^* v^2}{48\pi^2} \right] \sum_k \frac{Y_{ik} Y_{jk}}{M_k}. \quad (22)$$

From this expression we can estimate the high-energy scale of our model and the corresponding value for  $v_\Phi$  in Eq. (9). For illustrative purposes, we take the same values for the mass parameters ( $\mu_\Phi = M_\Sigma = \Lambda_{NP}$ ) and the empirical input values  $v = 174$  GeV and  $m_\nu \sim 0.1$  eV. For the moderate values  $Y \sim 10^{-3}$ ,  $\lambda_4 \sim 10^{-2}$  and  $\lambda_5 \sim 10^{-4}$  we get

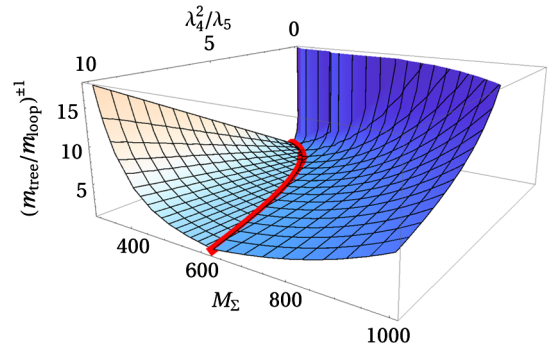

FIG. 3 (color online). For the portion of the parameter space left from the equality-division line, where the tree-level contribution to neutrino masses dominates, we plot  $m_{\text{tree}}/m_{\text{loop}}$ . Right from the equality-division line, the one-loop contribution to neutrino masses dominates, and we plot  $m_{\text{loop}}/m_{\text{tree}}$ .

$\Lambda_{NP} \simeq 440$  GeV and  $v_\Phi \simeq 160$  MeV. Corresponding masses of the new states could be tested at the LHC. In Fig. 3 we display the part of the parameter space for which the tree-level (loop-level) contribution dominates.

#### IV. PRODUCTION OF QUINTUPLET LEPTONS AT THE LHC

The production channels of the heavy quintuplet leptons in proton-proton collisions are dominated by the quark-antiquark annihilation via neutral and charged gauge bosons

$$q + \bar{q} \rightarrow A \rightarrow \Sigma + \bar{\Sigma}, \quad A = \gamma, Z, W^\pm,$$

where the gauge Lagrangian relevant for the production is given by

$$\begin{aligned} \mathcal{L}_{\text{gauge}}^{\Sigma\bar{\Sigma}} = & +e(2\bar{\Sigma}^{++}\gamma^\mu\Sigma^{++} + \bar{\Sigma}^+\gamma^\mu\Sigma^+)A_\mu \\ & + g \cos\theta_W(2\bar{\Sigma}^{++}\gamma^\mu\Sigma^{++} + \bar{\Sigma}^+\gamma^\mu\Sigma^+)Z_\mu \\ & + g(\sqrt{2}\bar{\Sigma}^+\gamma^\mu\Sigma^{++} + \sqrt{3}\bar{\Sigma}^0\gamma^\mu\Sigma^+)W_\mu^- + \text{H.c.} \end{aligned} \quad (23)$$

The cross section for the partonic process is

$$\hat{\sigma}(q\bar{q} \rightarrow \Sigma\bar{\Sigma}) = \frac{\beta(3 - \beta^2)}{48\pi} \hat{s}(V_L^2 + V_R^2), \quad (24)$$

where  $\hat{s} \equiv (p_q + p_{\bar{q}})^2$  is the Mandelstam variable  $s$  for the quark-antiquark system, the parameter  $\beta \equiv \sqrt{1 - 4M_\Sigma^2/\hat{s}}$  denotes the heavy lepton velocity, and the left- and right-handed couplings are given by

$$V_{L,R}^{(\gamma+Z)} = \frac{Q_\Sigma Q_q e^2}{\hat{s}} + \frac{g^{Z\Sigma} g_{L,R}^q g^2}{c_W^2(\hat{s} - M_\Sigma^2)}, \quad (25)$$

$$V_L^{(W^-)} = \frac{g^{W\Sigma} g^2 V_{ud}}{\sqrt{2}(\hat{s} - M_W^2)} = V_L^{(W^+)*}, \quad (26)$$

$$V_R^{(W^\pm)} = 0. \quad (27)$$

Here,  $g_L^q = T_3 - s_W^2 Q_q$  and  $g_R^q = -s_W^2 Q_q$  are the SM chiral quark couplings to the  $Z$  boson. The vector couplings of heavy leptons to gauge bosons are

$$g^{Z\Sigma} = T_3 - s_W^2 Q_\Sigma \quad \text{and} \quad g^{W\Sigma} = \sqrt{2} \quad \text{or} \quad \sqrt{3}, \quad (28)$$

where  $g^{W\Sigma}$  can be read of the last row in Eq. (23), relevant for the production of  $\Sigma^{++}\bar{\Sigma}^+$  and  $\Sigma^+\bar{\Sigma}^0$  pairs, respectively.

In evaluating the cross sections for a hadron collider, the partonic cross section (24) has to be convoluted with the appropriate parton distribution functions (PDFs). To

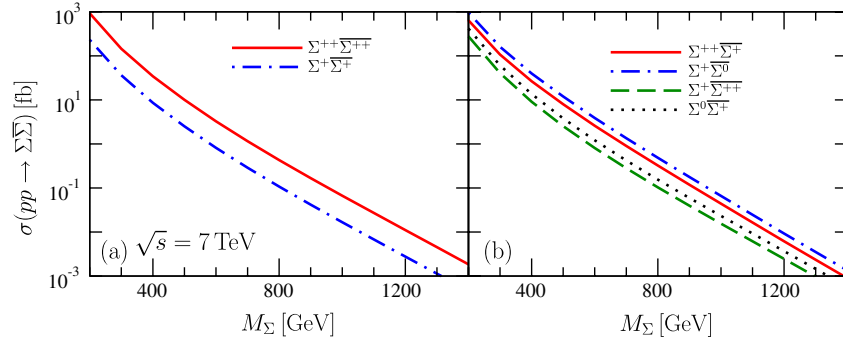

FIG. 4 (color online). The cross sections for production of quintuplet lepton pairs on LHC proton-proton collisions at  $\sqrt{s} = 7$  TeV via neutral  $\gamma, Z$  (a) and charged  $W^\pm$  currents (b), in dependence on the heavy quintuplet mass  $M_\Sigma$ .

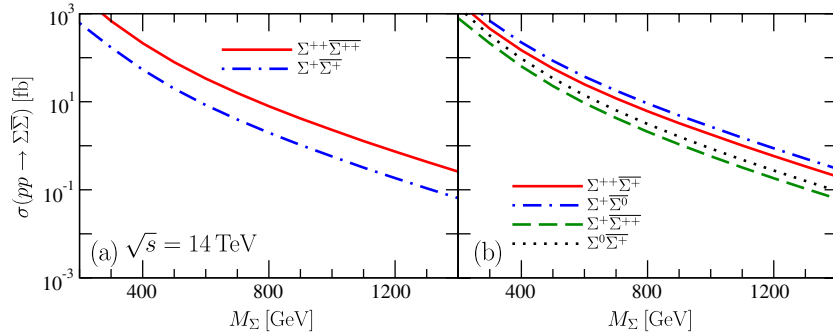

FIG. 5 (color online). Same as Fig. 4, but for designed  $\sqrt{s} = 14$  TeV at the LHC.

TABLE I. Production cross sections for  $\Sigma$ - $\bar{\Sigma}$  pairs for the LHC run at  $\sqrt{s} = 7$  TeV, for three selected values of  $M_\Sigma$ .

Produced pair	Cross section (fb)		
	$M_\Sigma = 200$ GeV	$M_\Sigma = 400$ GeV	$M_\Sigma = 800$ GeV
$\Sigma^{++}\bar{\Sigma}^{++}$	924	34.4	0.43
$\Sigma^+\bar{\Sigma}^+$	231	8.6	0.11
$\Sigma^{++}\bar{\Sigma}^+$	641	26.5	0.32
$\Sigma^+\bar{\Sigma}^0$	961	39.8	0.49
$\Sigma^+\bar{\Sigma}^{++}$	276	9.1	0.10
$\Sigma^0\bar{\Sigma}^+$	414	13.6	0.15
Total	3447	132	1.6

evaluate the cross sections we have used CTEQ6.6 PDFs [13] via LHAPDF software library [14].

The cross sections for proton-proton collisions are presented on Fig. 4 for  $\sqrt{s} = 7$  TeV appropriate for the 2011 LHC run, and for designed  $\sqrt{s} = 14$  TeV on Fig. 5. Thereby we distinguish separately the production via neutral currents shown on the left panel, and via charged currents shown on the right panel of Figs. 4 and 5.

We extract in Table I the pair production cross sections from Fig. 4 for three selected values of  $M_\Sigma$ . From this table we find that the doubly-charged  $\Sigma^{++}$  has the largest production cross section  $\sigma(\Sigma^{++})|_{M_\Sigma=400 \text{ GeV}} = 60.9$  fb and doubly-charged  $\bar{\Sigma}^{++}$  has the smallest, still comparable  $\sigma(\bar{\Sigma}^{++})|_{M_\Sigma=400 \text{ GeV}} = 43.5$  fb. The production rates of other heavy leptons are in between. On Fig. 6 we plot the expected number of produced  $\Sigma^{++}$  and  $\bar{\Sigma}^{++}$  particles for three characteristic collider setups. In particular, for  $5 \text{ fb}^{-1}$  of integrated luminosity of 2011 LHC run at  $\sqrt{s} = 7$  TeV, there should be about 520 doubly-charged  $\Sigma^{++}$  or  $\bar{\Sigma}^{++}$  fermions produced. In total, there should be 660  $\Sigma$ - $\bar{\Sigma}$  pairs produced.

By testing the heavy lepton production cross sections, one can hope to identify the quantum numbers of the quintuplet particles, but in order to confirm their relation to neutrinos, one has to study their decays.

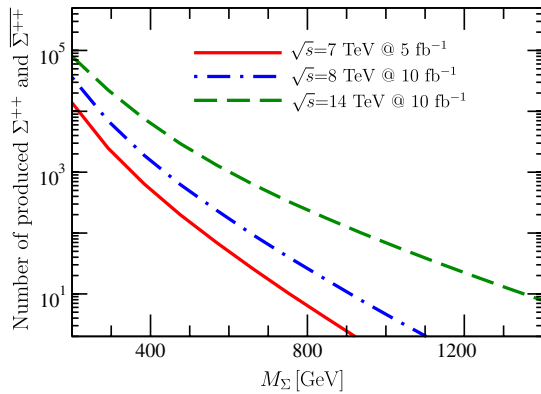

FIG. 6 (color online). Number of  $\Sigma^{++}$  and  $\bar{\Sigma}^{++}$  particles produced for three characteristic LHC collider setups, in dependence on the heavy lepton mass  $M_\Sigma$ .

## V. DECAYS OF QUINTUPLET STATES

Our focus here is entirely on the decay modes of the heavy lepton states listed in Eq. (7). Namely, provided that in our scenario the exotic scalar states are slightly heavier than the exotic leptons, the exotic scalar fields will not appear in the final states of heavy lepton decays. Note that exotic scalar states  $\Phi \sim (1, 4, 1)$  were considered recently in [15], in the context of modified type III seesaw model.

The couplings relevant for the decays at hand stem from off-diagonal entries in the mass matrices in Eqs. (11) and (12). The diagonalization of these matrices can be achieved by making the following unitary transformations on the lepton fields:

$$\begin{aligned} \begin{pmatrix} (\nu_L)^c \\ \Sigma_R^0 \end{pmatrix} &= U^0 \begin{pmatrix} (\nu_{mL})^c \\ \Sigma_{mR}^0 \end{pmatrix}, \\ \begin{pmatrix} l_L \\ (\Sigma_R^+)^c \end{pmatrix} &= U^L \begin{pmatrix} l_{mL} \\ (\Sigma_{mR}^+)^c \end{pmatrix}, \\ \begin{pmatrix} l_R \\ (\Sigma_L^+)^c \end{pmatrix} &= U^R \begin{pmatrix} l_{mR} \\ (\Sigma_{mL}^+)^c \end{pmatrix}. \end{aligned} \quad (29)$$

Following the procedure in Refs. [7,16,17], the matrices  $U^0$  and  $U^{L,R}$  can be expressed in terms of  $Y\nu_\Phi$  and  $M$ . Thereby, by expanding  $U^0$  and  $U^{L,R}$  in powers of  $M^{-1}$  and keeping only the leading-order terms, we get

$$\begin{aligned} U^0 &\equiv \begin{pmatrix} V_{PMNS}^* & \frac{1}{\sqrt{2}}\nu_\Phi^* Y^* M^{-1} \\ -\frac{1}{\sqrt{2}}\nu_\Phi M^{-1} Y^T V_{PMNS}^* & 1 \end{pmatrix}, \\ U^L &\equiv \begin{pmatrix} 1 & -\frac{\sqrt{3}}{2}\nu_\Phi Y M^{-1} \\ \frac{\sqrt{3}}{2}\nu_\Phi M^{-1} Y^\dagger & 1 \end{pmatrix}, \quad U^R \equiv \begin{pmatrix} 1 & 0 \\ 0 & 1 \end{pmatrix}. \end{aligned} \quad (30)$$

Here,  $V_{PMNS}$  is a  $3 \times 3$  unitary matrix which diagonalizes the effective light neutrino mass matrix in Eq. (21), and the nondiagonal entries are related to the sought couplings of heavy and light leptons, and are expressed in terms of the matrix-valued quantity

$$V_{l\Sigma} = (\nu_\Phi Y M^{-1})_{l\Sigma}. \quad (32)$$

Next, for simplicity, we suppress the indices indicating the mass-eigenstate fields. The Lagrangian in the mass-eigenstate basis, relevant for the decays of the heavy leptons, has the neutral current part

$$\begin{aligned} \mathcal{L}_{NCZ} &= \frac{g}{c_W} \left[ \bar{\nu} \left( \frac{1}{2\sqrt{2}} V_{PMNS}^\dagger V \gamma^\mu P_L \right. \right. \\ &\quad \left. \left. - \frac{1}{2\sqrt{2}} V_{PMNS}^T V^* \gamma^\mu P_R \right) \Sigma^0 \right. \\ &\quad \left. + \bar{l}^c \left( \frac{\sqrt{3}}{4} V^* \gamma^\mu P_R \right) \Sigma^+ + \text{H.c.} \right] Z_\mu^0, \end{aligned} \quad (33)$$

and the charged current part

$$\begin{aligned}
 \mathcal{L}_{CC} = & g \left[ \bar{\nu} \left( -\sqrt{\frac{3}{2}} V_{PMNS}^\dagger V \gamma^\mu P_L \right. \right. \\
 & + \left. \frac{-\sqrt{3}}{2\sqrt{2}} V_{PMNS}^T V^* \gamma^\mu P_R \right) \Sigma^+ + \bar{l} (-V \gamma^\mu P_L) \Sigma^0 \\
 & \left. + \bar{l}^c \left( \sqrt{\frac{3}{2}} V^* \gamma^\mu P_R \right) \Sigma^{++} \right] W_\mu^- + \text{H.c.} \quad (34)
 \end{aligned}$$

Let us start our list of the partial decay widths by the decays of neutral  $\Sigma^0$  state

$$\begin{aligned}
 \Gamma(\Sigma^0 \rightarrow \ell^\mp W^\pm) &= \frac{g^2}{32\pi} |V_{\ell\Sigma}|^2 \frac{M_\Sigma^3}{M_W^2} \left(1 - \frac{M_W^2}{M_\Sigma^2}\right)^2 \\
 &\quad \times \left(1 + 2 \frac{M_W^2}{M_\Sigma^2}\right), \\
 \sum_{m=1}^3 \Gamma(\Sigma^0 \rightarrow \nu_m Z^0) &= \frac{g^2}{32\pi c_W^2} \sum_{\ell=\{e,\mu,\tau\}} \frac{1}{4} |V_{\ell\Sigma}|^2 \frac{M_\Sigma^3}{M_Z^2} \\
 &\quad \times \left(1 - \frac{M_Z^2}{M_\Sigma^2}\right)^2 \left(1 + 2 \frac{M_Z^2}{M_\Sigma^2}\right). \quad (35)
 \end{aligned}$$

The positive singly-charged heavy lepton  $\Sigma^+$  has the following partial decay widths:

$$\begin{aligned}
 \Gamma(\Sigma^+ \rightarrow \ell^+ Z^0) &= \frac{g^2}{32\pi c_W^2} \frac{3}{16} |V_{\ell\Sigma}|^2 \frac{M_\Sigma^3}{M_Z^2} \left(1 - \frac{M_Z^2}{M_\Sigma^2}\right)^2 \\
 &\quad \times \left(1 + 2 \frac{M_Z^2}{M_\Sigma^2}\right), \\
 \sum_{m=1}^3 \Gamma(\Sigma^+ \rightarrow \nu_m W^+) &= \frac{g^2}{32\pi} \sum_{\ell=\{e,\mu,\tau\}} \frac{15}{8} |V_{\ell\Sigma}|^2 \frac{M_\Sigma^3}{M_W^2} \\
 &\quad \times \left(1 - \frac{M_W^2}{M_\Sigma^2}\right)^2 \left(1 + 2 \frac{M_W^2}{M_\Sigma^2}\right). \quad (36)
 \end{aligned}$$

Finally, the doubly-charged  $\Sigma^{++}$  state decays exclusively via a charged current, with the partial decay width

$$\begin{aligned}
 \Gamma(\Sigma^{++} \rightarrow \ell^+ W^+) &= \frac{g^2}{32\pi} \frac{3}{2} |V_{\ell\Sigma}|^2 \frac{M_\Sigma^3}{M_W^2} \left(1 - \frac{M_W^2}{M_\Sigma^2}\right)^2 \\
 &\quad \times \left(1 + 2 \frac{M_W^2}{M_\Sigma^2}\right). \quad (37)
 \end{aligned}$$

The mass difference induced by loops of SM gauge bosons between two components of  $\Sigma$  quintuplet with electric charges  $Q$  and  $Q'$  is explicitly calculated in [1]

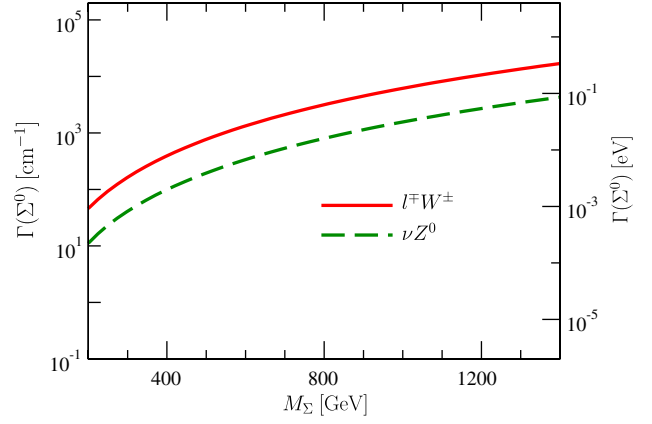

FIG. 7 (color online). Partial decay widths of  $\Sigma^0$  quintuplet lepton for  $|V_{l\Sigma}| = 3.5 \times 10^{-7}$ , in dependence on heavy quintuplet mass  $M_\Sigma$ .

$$\begin{aligned}
 M_Q - M_{Q'} &= \frac{\alpha_2 M}{4\pi} \left\{ (Q^2 - Q'^2) s_W^2 f\left(\frac{M_Z}{M}\right) + (Q - Q') \right. \\
 &\quad \times (Q + Q' - Y) \left[ f\left(\frac{M_W}{M}\right) - f\left(\frac{M_Z}{M}\right) \right] \Big\}, \\
 f(r) &= \frac{r}{2} \left[ 2r^3 \ln r - 2r + (r^2 - 4)^{1/2} (r^2 + 2) \right. \\
 &\quad \left. \times \ln\left(\frac{r^2 - 2 - r\sqrt{r^2 - 4}}{2}\right) \right]. \quad (38)
 \end{aligned}$$

The values for the mass splittings  $\Delta M_{ij} = M_i - M_j$  in Eq. (38) for  $M_\Sigma = 400$  GeV are

$$\begin{aligned}
 \Delta M_{21} &\equiv M_{\Sigma^{++}} - M_{\Sigma^+} \simeq 490 \text{ MeV}, \\
 \Delta M_{10} &\equiv M_{\Sigma^+} - M_{\Sigma^0} \simeq 163 \text{ MeV}, \quad (39)
 \end{aligned}$$

which opens additional decay channels, like  $\Sigma^{++} \rightarrow \pi^+ \Sigma^+$  and  $\Sigma^+ \rightarrow \pi^+ \Sigma^0$ . The decay rate for a single pion final state is given by

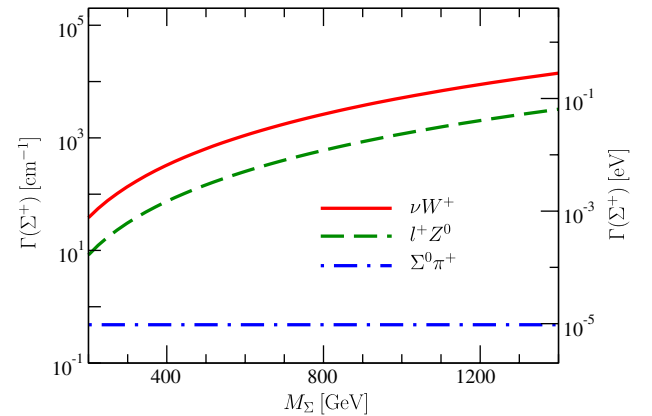

FIG. 8 (color online). Partial decay widths of  $\Sigma^+$  quintuplet lepton for  $|V_{l\Sigma}| = 3.5 \times 10^{-7}$ , in dependence on heavy quintuplet mass  $M_\Sigma$ .

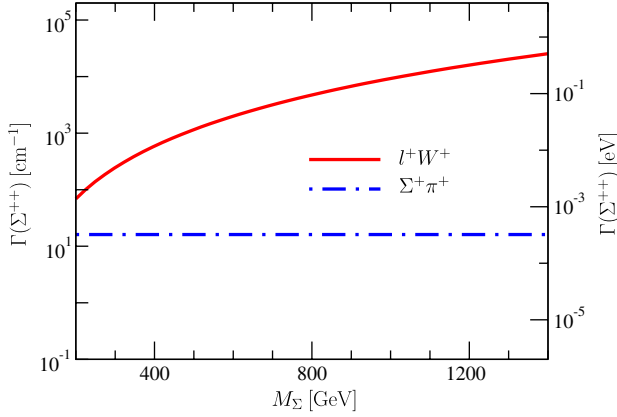

FIG. 9 (color online). Partial decay widths of  $\Sigma^{++}$  quintuplet lepton for  $|V_{l\Sigma}| = 3.5 \times 10^{-7}$ , in dependence on heavy quintuplet mass  $M_\Sigma$ .

$$\Gamma(\Sigma^i \rightarrow \Sigma^j \pi^+) = (g^{W\Sigma})_{ij}^2 \frac{2}{\pi} G_F^2 |V_{ud}|^2 f_\pi^2 (\Delta M_{ij})^3 \times \sqrt{1 - \frac{m_\pi^2}{(\Delta M_{ij})^2}}, \quad (40)$$

where  $(g^{W\Sigma})_{ij}^2$  is given in Eq. (28). These decays are suppressed by small mass differences.

In Figs. 7–9 we plot the partial widths of the decays of  $\Sigma^0$ ,  $\Sigma^+$  and  $\Sigma^{++}$  given in Eqs. (35)–(37), respectively. Figures 8 and 9 also show pion final state decays from Eq. (40). We list the representative final states of these decays in Table II, which includes same-sign dilepton events as distinguished signatures at the LHC.

## VI. POSSIBLE ROLE AS DARK MATTER

The fermionic quintuplet of this paper was selected previously as a viable MDM candidate in [1]. To employ it as a seesaw mediator requires additional scalar multiplets, which makes the neutral component of the quintuplet unstable. If we employ a  $Z_2$  symmetry under which  $\Sigma \rightarrow -\Sigma$ ,  $\Phi \rightarrow -\Phi$  and all SM fields are unchanged,

the lightest component of the  $\Sigma$  and  $\Phi$  multiplets is again a DM candidate. The quartic  $\lambda_5$  term in the scalar potential is still allowed so that neutrinos acquire radiatively generated masses given by Eq. (17).

If  $\Sigma^0$  is the DM particle, its mass is fixed by the relic abundance to the value  $M_\Sigma \approx 10$  TeV in [1]. The choice  $\lambda_5 = 10^{-7}$  gives enough suppression to have small neutrino masses with large Yukawas,  $Y \sim 0.1$ . In this part of the parameter space the model could have interesting lepton flavor violating effects like in [8].

The neutral component of the scalar multiplet  $\Phi$  could also be a DM particle, despite its tree-level coupling to the Z boson. Similar to the inert doublet model, the  $\lambda_5$  term in the scalar potential in Eq. (4) splits the real and imaginary parts of the  $\Phi^0$  field. If the mass splitting is large enough, the inelastic scattering through the Z boson exchange is kinematically forbidden in direct detection experiments. In this case the new states could be within reach of the LHC. To ensure a large enough mass splitting, the coupling  $\lambda_5$  cannot be too small. Accordingly, from Eq. (17), it follows that the Yukawa couplings have to be smaller, suppressing the lepton flavor violating effects.

## VII. CONCLUSION

In this account we propose a TeV-scale model for neutrino masses based only on the gauge symmetry and the renormalizability of the SM. The model employs fermion quintuplets with zero hypercharge, which in isolation correspond to cosmological minimal dark matter candidate. Such TeV-scale fermions in conjunction with the scalar quadruplet can generate neutrino masses both by the tree-level contributions in Fig. 1 and the loop-level contributions in Fig. 2. Also, such states are expected to be abundantly produced at the LHC, and the distinctive signatures could come from doubly-charged components of the fermionic quintuplets. For  $5 \text{ fb}^{-1}$  of already accumulated integrated luminosity at the LHC ( $\sqrt{s} = 7$  TeV), there could be  $\sim 500$  produced doubly-charged  $\Sigma^{++}$  or  $\bar{\Sigma}^{++}$  fermions, with mass  $M_\Sigma = 400$  GeV. The decays of these states to SM charged

TABLE II. Decays of exotic leptons to SM charged leptons, including multilepton and same-sign dilepton events, together with their branching ratios (restricted to  $l = e, \mu$ ) and for  $M_\Sigma = 400$  GeV.

	$\bar{\Sigma}^{++} \rightarrow \ell^- W^-$ (0.66)	$\bar{\Sigma}^+ \rightarrow \ell^- Z^0$ (0.06)	$\Sigma^0 \rightarrow \ell^+ W^-$ (0.30)	$\Sigma^0 \rightarrow \ell^- W^+$ (0.30)
$\Sigma^{++} \rightarrow \ell^+ W^+$ (0.66)	$\ell^+ \ell^- W^+ W^-$ (0.44)	$\ell^+ \ell^- W^+ Z^0$ (0.04)	...	...
$\Sigma^+ \rightarrow \ell^+ Z^0$ (0.06)	$\ell^+ \ell^- Z^0 W^-$ (0.04)	$\ell^+ \ell^- Z^0 Z^0$ (0.004)	$\ell^+ \ell^+ Z^0 W^-$ (0.02)	$\ell^+ \ell^- Z^0 W^+$ (0.02)
$\Sigma^0 \rightarrow \ell^- W^+$ (0.30)	...	$\ell^- \ell^- W^+ Z^0$ (0.02)	...	...
$\Sigma^0 \rightarrow \ell^+ W^-$ (0.30)	...	$\ell^+ \ell^- W^- Z^0$ (0.02)	...	...



leptons have an interesting multilepton signature. There are, in addition, same-sign dilepton events displayed in Table II. These events have a negligible SM background, as demonstrated [18,19] in generic new physics scenario with lepton number violation. In particular, the detailed studies of fermionic triplets from type III seesaw scenario [17,20] apply to our case of fermionic quintuplets. The multilepton events listed in our Table II are in direct correspondence with the items from the type III seesaw given in Table 13 of Ref. [20], to which also the analysis in [17] refers. The signals that are good for the discovery correspond to a relatively high signal rate and small SM background, which is calculated by MADGRAPH [21]. In order to compare the signal and SM background cross sections, we assume a particular choice of parameters leading to the branching ratios given in Table II, restricted to  $l = e, \mu$  leptons in the final states. In this respect we distinguish four classes of events containing  $\Sigma^+$  decaying to  $e^+$  or  $\mu^+$  lepton and  $Z^0 \rightarrow (\ell^+ \ell^-, q\bar{q})$  resonance to help in  $\Sigma^+$  identification:

$$(i) pp \rightarrow \Sigma^+ \bar{\Sigma}^+ \rightarrow (\ell^+ Z^0)(\ell^- Z^0),$$

which has too small of a cross section (0.03 fb with respect to the SM background of 0.6 fb) at 7 TeV LHC;

$$(ii) pp \rightarrow \Sigma^+ \bar{\Sigma}^0 \rightarrow (\ell^+ Z^0)(\ell^- W^+),$$

which has a cross section of 0.7 fb, comparable to the SM background of 0.8 fb;

$$(iii) pp \rightarrow \Sigma^+ \bar{\Sigma}^0 \rightarrow (\ell^+ Z^0)(\ell^+ W^-),$$

the LNV event having 0.7 fb with the same-sign dilepton state, which is nonexistent in the SM and thus devoid of the SM background;

$$(iv) pp \rightarrow \Sigma^{++} \bar{\Sigma}^+ \rightarrow (\ell^+ W^+)(\ell^- Z^0),$$

having a relatively high signal rate (1.1 fb with respect to the SM background of 0.8 fb). The classes (iii) and (iv) lead to signals elaborately detailed in [17,20], which can be rescaled to infer on the LHC discovery reach.

The model of neutrino mass generation presented here represents a generalization of the fermion triplet seesaw mediator from the type III seesaw model to a hypercharge-zero quintuplet, which we postponed at the time of elaborating first its nonzero hypercharge variant in [6]. The hypercharge-zero quintuplet has been proposed subsequently in [22]. One can question the possibility to distinguish between the present hypercharge-zero quintuplet with a doubly-charged component and previously considered nonzero hypercharge states [6,7], which provide spectacular falsifiable triply-charged signatures. Consequently, a nonobservation of the latter would put in a forefront the hypercharge-zero quintuplets, which provide their neutral components as potential MDM candidates. However, a blow to the stability of such DM comes from the presence of additional fields needed to generate the described small neutrino masses. As usual, the stability can be restored by introducing the discrete symmetry under which the new states are odd, in which case neutrinos get mass only from radiative contributions.

## ACKNOWLEDGMENTS

This work is supported by the Croatian Ministry of Science, Education, and Sports under Contract No. 119-0982930-1016.

- 
- [1] M. Cirelli, N. Fornengo, and A. Strumia, *Nucl. Phys. B* **753**, 178 (2006); M. Cirelli and A. Strumia, *New J. Phys.* **11**, 105005 (2009).
- [2] S. Weinberg, *Phys. Rev. Lett.* **43**, 1566 (1979).
- [3] P. Minkowski, *Phys. Lett. B* **67**, 421 (1977); T. Yanagida, in *Proceedings of the Workshop on Unified Theory and the Baryon Number of the Universe*, edited by O. Sawada and A. Sugamoto (KEK, Tsukuba, 1979), p. 95; M. Gell-Mann, P. Ramond, and R. Slansky, in *Supergravity*, edited by P. van Nieuwenhuizen and D. Freedman (North Holland, Amsterdam, 1979), p. 315; S.L. Glashow, in *Quarks and Leptons*, edited by M. Lévy *et al.* (Plenum, New York, 1980), p. 707; R.N. Mohapatra and G. Senjanovic, *Phys. Rev. Lett.* **44**, 912 (1980).
- [4] W. Konetschny and W. Kummer, *Phys. Lett. B* **70**, 433 (1977); M. Magg and C. Wetterich, *Phys. Lett. B* **94**, 61 (1980); J. Schechter and J.W.F. Valle, *Phys. Rev. D* **22**, 2227 (1980); T.P. Cheng and L.F. Li, *Phys. Rev. D* **22**, 2860 (1980); G. Lazarides, Q. Shafi, and C. Wetterich, *Nucl. Phys. B* **181**, 287 (1981); R.N. Mohapatra and G. Senjanovic, *Phys. Rev. D* **23**, 165 (1981).
- [5] R. Foot, H. Lew, X.G. He, and G.C. Joshi, *Z. Phys. C* **44**, 441 (1989).
- [6] I. Picek and B. Radovčić, *Phys. Lett. B* **687**, 338 (2010).
- [7] K. Kumerički, I. Picek, and B. Radovčić, *Phys. Rev. D* **84**, 093002 (2011).
- [8] Y. Cai, X-G He, M. Ramsey-Musolf, and L-H Tsai, *J. High Energy Phys.* **12** (2011) 054.
- [9] K. Kumerički, I. Picek, and B. Radovčić, *arXiv:1204.6597*.
- [10] C.-H. Chen and S.S.C. Law, *Phys. Rev. D* **85**, 055012 (2012).
- [11] K. Nakamura *et al.* (Particle Data Group), *J. Phys. G* **37**, 075021 (2010).
- [12] E. Ma, *Phys. Rev. D* **73**, 077301 (2006).

- [13] P.M. Nadolsky, H.-L. Lai, Q.-H. Cao, J. Huston, J. Pumplin, D. Stump, W.-K. Tung, and C.-P. Yuan, *Phys. Rev. D* **78**, 013004 (2008).
- [14] M.R. Whalley, D. Bourilkov, and R.C. Group, [arXiv:hep-ph/0508110](https://arxiv.org/abs/hep-ph/0508110).
- [15] B. Ren, K. Tsumura, and X.-G. He, *Phys. Rev. D* **84**, 073004 (2011).
- [16] W. Grimus and L. Lavoura, *J. High Energy Phys.* **11** (2000) 042.
- [17] T. Li and X.-G. He, *Phys. Rev. D* **80**, 093003 (2009).
- [18] B. Mukhopadhyaya and S. Mukhopadhyay, *Phys. Rev. D* **82**, 031501 (2010); S. Mukhopadhyay and B. Mukhopadhyaya, *Phys. Rev. D* **84**, 095001 (2011).
- [19] F. del Aguila and J.A. Aguilar-Saavedra, *Phys. Lett. B* **672**, 158 (2009); J.A. Aguilar-Saavedra, *Nucl. Phys.* **B828**, 289 (2010).
- [20] F. del Aguila and J.A. Aguilar-Saavedra, *Nucl. Phys.* **B813**, 22 (2009).
- [21] J. Alwall, M. Herquet, F. Maltoni, O. Mattelaer, and T. Stelzer, *J. High Energy Phys.* **06** (2011) 128.
- [22] Y. Liao, *J. High Energy Phys.* **06** (2011) 098.