

Inverse limit spaces of interval maps

Anušić, Ana

Doctoral thesis / Disertacija

2019

Degree Grantor / Ustanova koja je dodijelila akademski / stručni stupanj: **University of Zagreb, Faculty of Science / Sveučilište u Zagrebu, Prirodoslovno-matematički fakultet**

Permanent link / Trajna poveznica: <https://um.nsk.hr/um:nbn:hr:217:255744>

Rights / Prava: [In copyright](#)/[Zaštićeno autorskim pravom.](#)

Download date / Datum preuzimanja: **2024-09-27**



Repository / Repozitorij:

[Repository of the Faculty of Science - University of Zagreb](#)





University of Zagreb

FACULTY OF SCIENCE
DEPARTMENT OF MATHEMATICS

Ana Anušić

**INVERSE LIMIT SPACES OF INTERVAL
MAPS**

DOCTORAL THESIS

Zagreb, 2018



Sveučilište u Zagrebu

PRIRODOSLOVNO - MATEMATIČKI FAKULTET
MATEMATIČKI ODSJEK

Ana Anušić

**INVERZNI LIMESI PRESLIKAVANJA NA
INTERVALU**

DOKTORSKI RAD

Zagreb, 2018.



University of Zagreb

FACULTY OF SCIENCE
DEPARTMENT OF MATHEMATICS

Ana Anušić

INVERSE LIMIT SPACES OF INTERVAL MAPS

DOCTORAL THESIS

Supervisors:

Univ.-Prof. PhD Henk Bruin
izv. prof. dr. sc. Sonja Štimac

Zagreb, 2018



Sveučilište u Zagrebu

PRIRODOSLOVNO - MATEMATIČKI FAKULTET
MATEMATIČKI ODSJEK

Ana Anušić

INVERZNI LIMESI PRESLIKAVANJA NA INTERVALU

DOKTORSKI RAD

Mentori:

Univ.-Prof. PhD Henk Bruin
izv. prof. dr. sc. Sonja Štimac

Zagreb, 2018.

Acknowledgements

During my PhD studies I have met so many extraordinary people who became not only my future colleagues but my dear friends. They all deserve to be mentioned here and it is going to be really hard not to leave somebody out.

I would like to express my deepest gratitude to my supervisors Sonja Štimac and Henk Bruin. Sonja, thank you for introducing me to the area, giving me a push into the community, and for the life lessons I am still to comprehend. Henk, thank you for openly sharing your knowledge, treating me like an equal from the very beginning, never locking your doors, and turtle keeping it simple. I am also deeply indebted to Jernej and Vesna Činč. Guys, thank you for being the best friends a person can have. Jernej, I also have to thank you for your patience during our collaboration.

The completion of this thesis would not have been possible without Martina Stojić and Goran Erceg who shared their template with me, Mario Stipčić who helped me hand the thesis in, and the committee members who carefully read the first drafts and improved it with valuable comments.

I am extremely grateful for the patience and encouragement of mathematical communities I consider myself a part of, namely:

Zagreb Topology Seminar, thanks for accepting me since I was an undergrad and helping me shape my results with your questions. I very much appreciate the enthusiasm of Professor Ivan Ivanšić during our Friday meetings and warm recommendations of Zoran Škoda.

Topology Seminar Ljubljana-Maribor-Zagreb, thank you for giving me the first glimpse of the international mathematical spirit and for the friendly atmosphere. Special thanks to Iztok Banič for introducing me to Jure, Alpha

and Tupki and to Boštjan Lemež for the interesting discussions during our trip to Auburn, Atlanta.

Department of Applied Mathematics at Faculty of Electrical Engineering and Computing, thank you for making the workplace feel like home. Special thanks to the D153 one-and-two-stars crew, and to everybody who selflessly accepted more work to support my constant absence.

Ergodic Theory and Dynamical Systems group in Vienna, thank you for always treating me as your own and making Vienna my second home. Many thanks to my long-term landlord Roland Zweimüller, my external memory Maik Gröger, and crazy people who trusted me with their plants - Oliver Butterley and Henna Koivusalo.

I would also like to thank all the mathematicians I have met around the world. Thank you for welcoming me warmly in the community, and readily answering my questions with a smile on your face. I am extremely grateful to Logan Hoehn and John Mayer for making me interested in planar embeddings of tree-like continua, Lori Alvin for showing me how to find hidden adding machines, Judy Kennedy for teaching me to eagerly grab everything life gives me, Roman Hric for giving me kung-fu fighting lessons, and to Chris Mouron for making me realize that purple and brown can make green.

I must acknowledge the friendship with Mate Puljiz who hosted me in UK many times, introduced me to his group there, and gave new perspectives on many interesting math problems.

Thanks to all my mathematical teachers from elementary school onwards, notably Dinka Žanić who told me that mathematics is a horrible career choice I should pursue, and Mirna Šašić-Smojver for teaching me to always work hard and never laugh with my mouth full.

Finally, none of this would have been possible without the constant love from my family and friends. Thank you for supporting all my crazy life choices and unquestionably believing my mathematics can change the world.

Contents

Contents	iii
1 Introduction	1
2 Preliminaries	15
2.1 Chainable continua	15
2.2 Inverse limit spaces	18
2.3 Dynamics of unimodal interval maps	22
2.3.1 Tent map family	25
2.3.2 The Milnor-Thurston kneading theory for tent maps . .	26
2.3.3 Hofbauer tower	30
3 Unimodal inverse limit spaces	34
3.1 Definition and basic properties	34
3.2 Symbolic description	35
3.3 Basic arcs	37
3.4 Inhomogeneities	40
3.5 Arc-components	48
4 The Core Ingram Conjecture	50
4.1 Patterns and symmetry	52
4.2 The structure of \mathfrak{R} – arcs A_i	55
4.3 ε -symmetry	59
4.4 Completeness of the sequence $\{A_i\}_{i \in \mathbb{N}}$	60
4.5 ε -symmetry and ε -closeness in the infinite non-recurrent case .	62

4.6	Topological uniqueness of \mathfrak{R}	66
4.7	The main theorem	71
5	Planar embeddings of chainable continua	80
5.1	Permuting the graph	82
5.2	Chain refinements and stretching	83
5.3	Composing chain refinements	86
5.4	Construction of the embeddings	87
5.5	Zig-zags	89
5.6	Thin embeddings	98
5.7	Uncountably many non-equivalent embeddings	101
	Bibliography	110
	Abstract	118
	Sažetak	119
	Curriculum vitae	122
	Životopis	124

Chapter 1

Introduction

This thesis studies the topological properties of inverse limit spaces with continuous interval bonding maps. In the first part (Chapters 3 and 4) we focus on the topology of unimodal inverse limit spaces, and in the second (Chapter 5) we construct different planar embeddings of chainable continua with respect to their accessible sets.

Inverse limits with application in dynamical systems

The inverse limit construction gives a method to efficiently describe spaces obtained as nested intersections of (closed) discs in the ambient metric space. Assume that we are given a sequence of non-empty compact connected metric spaces (*i.e.*, *continua*) $\{X_n\}_{n \in \mathbb{N}_0}$ and continuous maps $f_n: X_n \rightarrow X_{n-1}$, for all $n \in \mathbb{N}$. The *inverse limit* of inverse sequence $\{X_n, f_n\}$ is the subset of $\prod_{n \in \mathbb{N}_0} X_n$, given by

$$X = \varprojlim \{X_n, f_n\} = \{(\dots, x_{-2}, x_{-1}, x_0) : f_{n+1}(x_{-(n+1)}) = x_{-n}, n \in \mathbb{N}_0\},$$

and equipped with the product topology. Spaces X_n are called *factor spaces* and maps f_n are called *bonding maps*. It is easy to see that every inverse limit of continua is also a continuum. Conversely, every continuum X is homeomorphic to an inverse limit of compact connected polyhedra with onto bonding maps (Freudenthal [44]). Here by *polyhedron* we mean a compact

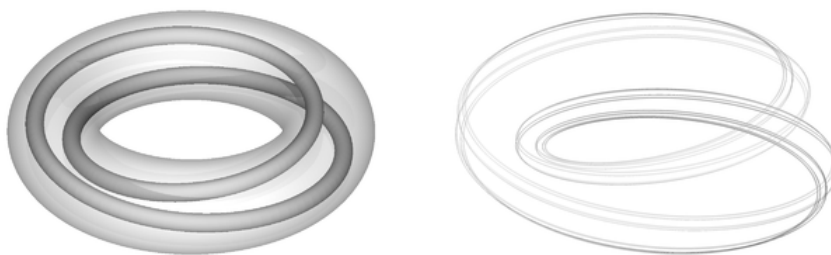

Figure 1.1: Formation of the dyadic solenoid¹. Left: map $F: \mathbb{D}^2 \times \mathbb{S}^1 \rightarrow \mathbb{D}^2 \times \mathbb{S}^1$ of the solid torus. Right: approximation of the attractor, $\bigcap_{n=1}^N F^n(\mathbb{D}^2 \times \mathbb{S}^1)$ for some large $N \in \mathbb{N}$.

triangulable space (*i.e.*, homeomorphic to a simplicial complex). Thus the use of inverse limits in topology (general as well as algebraic and specifically shape theory) is immediate; it basically gives an approximation of spaces by polyhedra.

On the other hand, nested intersections (and thus also inverse limits) naturally appear in topological dynamics. Assume we are given a topological space M (often a manifold) and a continuous map (often with some extra smoothness assumptions) $F: M \rightarrow M$. Space $\Lambda \subset M$ is called an *attractor* of F if there exists an open set $U \supset \Lambda$ such that $F(\text{Cl}(U)) \subset U$ and $\Lambda = \bigcap_{n \in \mathbb{N}} F^n(U)$. Such an attractor is a set which attracts forward orbits of points close to it. Often one requires the topological transitivity of $F|_{\Lambda}$, which roughly (on compact metric spaces) implies the existence of a (typical) set of dense orbits. This means that the forward orbit $\{F^n(x) : n \in \mathbb{N}\}$ of almost every $x \in U$ will be plotting the whole (strange) attractor, see *e.g.* the formation of the dyadic solenoid in Figure 1.1. By a *strange attractor* we usually mean an attractor carrying certain *fractal structure*.

Note that an attractor is naturally the inverse limit of the sequence $\{F^n(U), i_n\}$, where $i_n: F^n(U) \rightarrow F^{n-1}(U)$ are inclusions, but it would be much more useful to describe Λ as an inverse limit on a single space with a single bonding map such that the shift map is conjugate to the action of the original map F . To be more precise, one wants to find a (the simpler the better) topological space

¹Pictures taken from [https://en.wikipedia.org/wiki/Solenoid_\(mathematics\)](https://en.wikipedia.org/wiki/Solenoid_(mathematics)).

Y and a continuous $f: Y \rightarrow Y$ such that $\Lambda = \varprojlim\{Y, f\}$ and the maps $F|_\Lambda$ and $\sigma: \varprojlim\{Y, f\} \rightarrow \varprojlim\{Y, f\}$ given by

$$\sigma((\dots, x_{-2}, x_{-1}, x_0)) = (\dots, x_{-2}, x_{-1}, x_0, f(x_0))$$

are topologically conjugate, *i.e.*, there exists a homeomorphism $h: \varprojlim\{Y, f\} \rightarrow \Lambda$ such that the diagram in Figure 1.2 commutes (consequently, F and σ have the same dynamical properties).

$$\begin{array}{ccc} \varprojlim\{Y, f\} & \xrightarrow{\sigma} & \varprojlim\{Y, f\} \\ h \downarrow & & \downarrow h \\ \Lambda & \xrightarrow{F} & \Lambda \end{array}$$

Figure 1.2: Topological conjugation of F and σ .

The ideas originated from Smale's school in the 60's. It turns out that the crucial requirement for such a representation is the *uniform hyperbolicity* of map F . Williams proved in [86] that for one-dimensional uniformly hyperbolic attractors there exists a *branched 1-manifold* Y and a continuous $f: Y \rightarrow Y$ such that (Λ, F) and $(\varprojlim\{Y, f\}, \sigma)$ are topologically conjugate. We note here that $\varprojlim\{Y, f\}$ from Williams' result are *solenoids*, which are locally homeomorphic to the Cantor set of open arcs (see *e.g.* the dyadic solenoid in Figure 1.1). Later we will study attractors which contain *folding points*, which makes them substantially more complicated than Williams' uniformly hyperbolic solenoids.

Unfortunately, there are many systems which do not carry the hyperbolic structure, even on simple spaces like *e.g.* the plane. Probably the most prominent planar systems lacking the hyperbolic structure come from the family of Hénon maps $H_{a,b}: \mathbb{R}^2 \rightarrow \mathbb{R}^2$,

$$H_{a,b}(x, y) = (1 + y - ax^2, bx),$$

for $a, b \in \mathbb{R}$, see the attractor of Hénon's original example [51] in Figure 1.3.

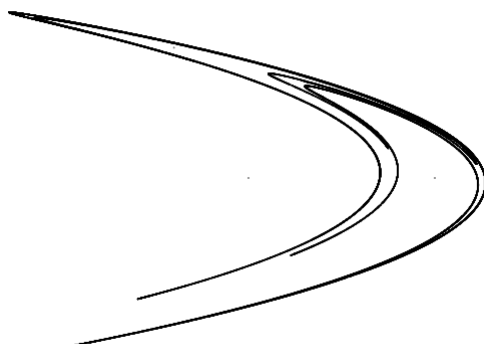
Figure 1.3: Hénon attractor² for $a = 1.4$, $b = 0.3$.

The existence of parameters $a, b \in \mathbb{R}$ for which there exists a strange attractor was proven by Benedicks and Carleson in [20], but to this day not much is known about their topology. For certain parameters the situation is simple. Namely, Barge and Holte prove in [15] that if b is small and if $a \in \mathbb{R}$ is such that the logistic map $f_a: [0, 1] \rightarrow [0, 1]$ given by $f_a(x) = ax(1-x)$ has an attracting periodic orbit, then $(\Lambda, H_{a,b}|_\Lambda)$ and $(\varprojlim\{[0, 1], f_a\}, \sigma)$ are conjugate. However, in general the situation gets a lot more complicated. Barge shows in [11] that the presence of *homoclinic tangencies* (*i.e.*, non-transversal intersections of stable and unstable manifolds) for map F makes it impossible to represent (Λ, F) as $(\varprojlim\{Y, f\}, \sigma)$, where Y is some finite graph. One can hope to find a more complicated space Y nevertheless. This approach was used in some conceptual *pruned horseshoe* models by de Carvalho and Hall in [39], but to our knowledge not developed further. Pruned horseshoe models were suggested by Cvitanović et al. in [42] and later developed by de Carvalho in [38].

At the end of this section we would like to point out the complicated topological structure of attractors with homoclinic tangencies. In [12] it is shown that such phenomena produce copies of every possible unimodal inverse limit space (defined below; this family contains uncountably many mutually non-homeomorphic continua, see *e.g.* [10]) in every small neighbourhood. Even

²Picture is taken from https://en.wikipedia.org/wiki/Henon_map.

more dramatic is the result from [66] showing that a small perturbation of a map with a homoclinic tangency can produce an attractor which locally resembles every inverse limit on intervals (including *e.g.* the pseudo-arc, the unique hereditarily indecomposable chainable continuum).

The topology of unimodal inverse limits

In the first part of the thesis we study *unimodal inverse limits*, which serve as simple models for dynamical systems beyond Williams' uniformly hyperbolic solenoids. That is, we study the topological properties of inverse limit spaces defined on the unit interval with a single *unimodal* bonding map. In general, unimodal map f on the interval $I = [0, 1]$ is a piecewise (strictly) monotone map for which $f(0) = f(1) = 0$ and which has a unique critical point in the interior of the interval. We will mostly focus on the family of tent maps, given by $T_s: I \rightarrow I$, $T_s(x) = \min\{sx, s(1-x)\}$, for $s \in (0, 2]$, see Figure 1.4. Denote the critical point by c and its images by $c_n = T_s^n(c)$. So the spaces of interest are

$$X_s = \varprojlim\{I, T_s\} = \varprojlim\{[0, c_1], T_s|_{[0, c_1]}\},$$

for $s \in [0, 2]$. Here $[0, c_1]$ is the maximal interval on which T_s is surjective. One readily checks that if $s < 1$, the space X_s is degenerate and thus not very interesting. For $s = 1$ the space X_s is an *arc*, *i.e.*, homeomorphic to the unit interval. For $s > 1$ there is an invariant interval $[c_2, c_1]$ called the core and all the points in $(0, c_2)$ are eventually mapped to the core. So it is not difficult to see that $X_s = \mathfrak{C} \cup X'_s$, where

$$X'_s = \varprojlim\{[c_2, c_1], T_s|_{[c_2, c_1]}\}$$

is a continuum called the core of X_s , and \mathfrak{C} is a topological ray which compactifies on the core. The endpoint of \mathfrak{C} is $(\dots, 0, 0, 0) \in X_s$. This facts were proven by Bennett [21] in his Master's thesis.

The restriction to the tent family might seem very strong, but it captures

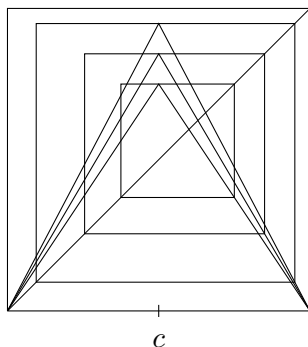

Figure 1.4: Graph of T_s for $s = 1.5, 1.7, 1.9$ with cores.

many features of unimodal dynamics and also interesting phenomena when we pass to the inverse limit. Actually, every unimodal map with no *wandering intervals*, no *attracting periodic points*, and which is not *renormalizable* is topologically conjugate to some tent map (see *e.g.* [70] and Section 2.3). In the inverse limit, wandering intervals or attracting periodic points will produce shift invariant collection of arcs as subcontinua. The effect of renormalization is also very well understood in the inverse limit, see *e.g.* [10, 35] and specially [16] for the topological description of infinitely renormalizable unimodal map (like *e.g.* logistic map at the *Feigenbaum parameter*).

Barge and Martin show in [17] that, given a continuous $f: I \rightarrow I$, it is possible to construct an (orientation-preserving or orientation-reversing) homeomorphism $H_f: \mathbb{R}^2 \rightarrow \mathbb{R}^2$ with global attractor Λ homeomorphic to $\varprojlim \{I, f\}$ and such that H_f on Λ is conjugate to the shift homeomorphism on $\varprojlim \{I, f\}$. They note that the construction readily generalizes, as was later proven by Boyland, de Carvalho and Hall in [25], where the construction was simultaneously conducted on parametrized families. Specially, it was shown that $[1, 2] \ni s \mapsto H_{T_s}$ is continuous (C^0 topology) and that $\{X_s : s \in [1, 2]\}$ vary continuously in Hausdorff topology. We would like to note that the family of cores X'_s embedded in the plane in an orientation-preserving Barge-Martin way goes through very interesting sequence of bifurcations with respect to the set of *accessible points* and the *prime end rotation number*, as was recently shown in [24] (we obtained the same classification using symbolic computa-

tions in [7]). This results played a big role in motivating the last chapter of this thesis.

Let us indicate some basic topological properties of tent inverse limits. Naturally, every X_s is a continuum. Furthermore, every X_s is *chainable*. That means that there exist arbitrary small chain covers, where a *chain* is a cover which has an arc for a nerve. Generally, a continuum is chainable if and only if it is an inverse limit on intervals. It is P -like if and only if it is an inverse limit on spaces homeomorphic to P (and then it can be covered by an arbitrary small cover whose nerve is P). For example, the dyadic solenoid from Figure 1.1 is circle-like but not arc-like. Moreover, if $1 < s \leq \sqrt{2}$, then X_s is decomposable. More precisely, it is the union of two copies of X_{s^2} joined in the endpoints of their corresponding rays \mathfrak{C} . If $s > \sqrt{2}$, then X_s is *indecomposable*, *i.e.*, it cannot be represented as a union of two of its proper subcontinua. Note that indecomposable continua have uncountably many composants (*composant* of a point $x \in X$ is the union of all proper subcontinua of X which contain x) and each is dense in the whole space, see [76] and Chapter 2.

We specifically point out that the inverse limit of the full tent map T_2 (actually every open unimodal map) is commonly known as the *Knaster continuum*. It is probably the simplest example of an indecomposable continuum and is realized as the global attractor of the *Smale horseshoe* map, see Figure 1.5. Note that every point in X_2 has an open neighbourhood homeomorphic to the Cantor set of (open) arcs but one - the fixed point $(\dots, 0, 0)$.

In general, if we make a computer simulation of the Barge-Martin homeomorphism producing some X_s as the attractor, one might be led to conclude that we locally see the Cantor set of arcs almost everywhere. Points which do not have an (open) neighbourhood homeomorphic to the Cantor set of (open) arcs are called *folding points* and are extensively studied in Chapter 3. Every X_s , $s > 1$ will contain folding points, *e.g.* $(\dots, 0, 0)$, but there are folding points also when we strip \mathfrak{C} off. Actually, the simulations turn out to be dramatically deceiving - there are examples of X_s in which every point is

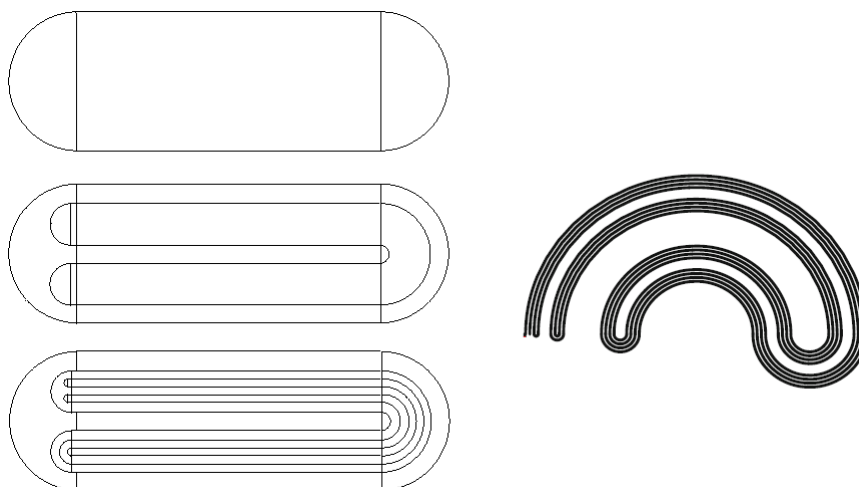

Figure 1.5: Left: Smale horseshoe map F is defined on a stadium-shaped region $D \subset \mathbb{R}^2$ in the topmost figure³. The following two figures show $F^2(D) \subset F(D) \subset D$. Right: The Knaster continuum, global attractor of F .

a folding point. This happens when the orbit of c is dense in the core; and it is the typical situation (*i.e.*, that happens for a dense G_δ set of parameters of full Lebesgue measure), see [9].

In Chapter 3 we study the topological properties of the set of folding points using its well-known characterization in terms of the omega-limit set of the critical point (Raines [79]). We distinguish the set of *endpoints* within the set of folding points and study its properties. An *endpoint* x in X_s is a point such that whenever two subcontinua $X, Y \subset X_s$ both contain x , then either $X \subset Y$ or $Y \subset X$ (think of *e.g.* $(\dots, 0, 0)$). It turns out that it can happen that every folding point is actually an endpoint, like *e.g.* in the inverse limit spaces of infinitely renormalizable unimodal maps. In 2010 Alvin and Brucks [2] asked for the characterization of X_s for which this happens. The main theorem in Section 3.4 gives an answer to this question.

Theorem 1.1. *Every folding point in X_s is an endpoint if and only if c is persistently recurrent.*

The definition of persistent recurrence (see Definition 3.20) first appeared

³Pictures are taken from [59].

in Lyubich's paper [63] in relation with the existence of *wild attractors* (*i.e.*, when metric and topological notion of an attractor disagree) in unimodal interval maps, where it turns out to be a necessary condition.

In order to obtain a complete understanding of the topological structure of spaces X_s , one might ask for a characterization of subcontinua, composants or arc-components. There are still many open questions in this direction. In Section 3.5 we use our knowledge of endpoints (precisely, *spiral* endpoints, see Definition 3.25) to give a symbolic characterization of arc-components in X_s , generalizing the result of Brucks and Diamond in [29]. Symbolically, arc-components can be characterized by a symbolic backward tail, with exception of at most two endpoints which are *spiral*. This result was included in paper [7]. Generally, topological classification of arc-components of X_s (as subspaces of X_s) is an entirely open question. We know that in X_2 all the arc-components (uncountably many of them) except \mathfrak{C} are homeomorphic, see Bandt [8], but no similar results exist for other X_s .

Topological classification of unimodal inverse limits

The question of classifying spaces X_s , commonly known as the *Ingram conjecture*, was open for a long time. It was first posed at 1992 Spring Topology Conference in Charlotte, where Tom Ingram asked if the three tent maps with critical orbit of period five generate topologically distinct inverse limits. Later, in his contribution to the Houston Problem Book [56, pg 257], Ingram attributes the original question to Stu Baldwin dated 1991. Barge and Diamond provide a positive answer to the period five case in [14], but naturally the classification in greater generality was also of interest. After some partial results in finite critical orbit case (see Swanson and Volkmer [84] and Bruin [31]), the conjecture was proven for periodic critical orbits by Kailhofer in [58] and finite critical orbits by Štimac in [83, 82]. (We say that the critical orbit is *finite* if the set $\{c_n : n \in \mathbb{N}_0\}$ is finite. It is *preperiodic* if it is finite and $c_n \neq c$ for all $n \in \mathbb{N}$, and *periodic* otherwise). Later, the result was extended to an uncountable class of infinite non-recurrent critical orbit case for which $\omega(c)$ is a Cantor set by Good and Raines in [46], infinite non-recurrent critical

orbit case in general by Raines and Štimac in [80], and finally to all X_s by Barge, Bruin and Štimac in 2012 [10]. (Here $\omega(c)$ is the set of limit points of $\{c_n : n \in \mathbb{N}_0\}$, the critical orbit is *non-recurrent* if $c \notin \omega(c)$, and *recurrent* otherwise. For more thorough definitions of the basic dynamical properties of unimodal maps see Definition 2.24).

However, in the proof of the Ingram conjecture, the authors extensively use the structure of ray \mathfrak{C} which is not contained in the core, leaving the topological classification of the cores X'_s open. Having \mathfrak{C} within the space is a great advantage since it must be preserved under homeomorphisms. Once it is removed, it cannot be constructed from the core anymore. This is for instance illustrated by the work of Minc [72] showing that in general there are uncountably many mutually non-homeomorphic rays which compactify on an arbitrary non-degenerate continuum.

In Chapter 4 (already published in paper [3]) we give a partial topological classification of cores of unimodal inverse limits, related to the following extension of the Ingram conjecture:

Question 1.2 (The Core Ingram Conjecture). *Is it true that if $\sqrt{2} < s < \tilde{s} \leq 2$, then X'_s and $X'_{\tilde{s}}$ are non-homeomorphic?*

In the process of proving the Ingram Conjecture, partial solutions of the Core Ingram Conjecture were obtained as well. Kailhofer [58], Good and Raines [46] and Štimac [82] all make use of a distinguished dense arc-component inside the core of the inverse limit space, so the result holds true for finite critical orbit case and certain subset of non-recurrent critical orbit case. In 2015 Bruin and Štimac [37] proved that the conjecture holds true for the set of parameters where the critical point is *Fibonacci-like*. The last result was obtained from observations on the arc-component \mathfrak{A} , which is the arc-component of the orientation reversing fixed point in the core.

We prove the Core Ingram Conjecture (in the positive) in case when both T_s and $T_{\tilde{s}}$ have the infinite non-recurrent critical orbits. In that case X'_s contains no endpoints and there exist infinitely many folding points. That gives a

topological distinction of infinite non-recurrent critical orbit case. The main theorem of this chapter is the following.

Theorem 1.3. *If $\sqrt{2} < s < \tilde{s} \leq 2$ and T_s and $T_{\tilde{s}}$ have infinite non-recurrent critical orbits, then X'_s and $X'_{\tilde{s}}$ are non-homeomorphic.*

The approach we utilize resembles Barge, Bruin and Štimac's proof in [10]. There the authors exploit the structure of *link-symmetric* arcs in \mathfrak{C} and, knowing that \mathfrak{C} is preserved by homeomorphisms, prove the conjecture. Here (following the approach in [37]) we replace the arc-component \mathfrak{C} by the arc-component \mathfrak{R} which exists in every X'_s and is dense in it. In general we can extract the structure of long link-symmetric arcs in \mathfrak{R} and show that it substantially differs for different slopes s . However, it is hard to prove that \mathfrak{R} is preserved under homeomorphisms. This is what we succeeded to prove only in infinite non-recurrent critical orbit case, leaving the Core Ingram Conjecture open in general. The result on the rigidity of the group of self-homeomorphisms of X'_s from [36] extends as well, so we obtain the following result too.

Theorem 1.4. *If $\sqrt{2} < s \leq 2$ and T_s has infinite non-recurrent critical orbit, then for every self-homeomorphism $h: X'_s \rightarrow X'_s$ there exists $R \in \mathbb{Z}$ such that h and σ^R are isotopic.*

Planar embeddings of chainable continua

Recall the mentioned Barge-Martin construction [17] which produces planar homeomorphisms with X_s for global attractors. There are two substantially different ways to perform the construction; one preserves the orientation and another reverses it (see the Smale horseshoe in Figure 1.5 for visualization). That gives two ways to embed spaces X_s in the plane, called *standard embeddings*. Standard embeddings of unimodal inverse limits were symbolically constructed by Brucks and Diamond in [29] (orientation preserving) and Bruin in [32] (orientation reversing). In 2015 Boyland asked the following questions:

Question 1.5 (Boyland 2015). *Is there an embedding of X_s in the plane not equivalent to standard embeddings? Is there such an embedding for which σ can be extended to a homeomorphism of the plane?*

We gave the positive answer to the first question in [5]. There are uncountably many non-equivalent planar embeddings of every X_s for $s > 1$. However, for non-standard embeddings in the constructed class the map σ is not extendable to a homeomorphism of the plane, as we showed in [7], leaving the second question open. The contents of papers [5] and [7] are not contained in this thesis. However, they have motivated the general study in Chapter 5. There we study planar embeddings of general chainable continua, partially answering the following long-standing open problem.

Question 1.6 (Nadler and Quinn, 1972). *Given a chainable continuum X and $x \in X$, is it possible to embed X in the plane such that x is accessible?*

A point $x \in X \subset \mathbb{R}^2$ is called *accessible* if there is an arc $A \subset \mathbb{R}^2$ such that $A \cap X = \{x\}$. It was shown in Bing's 1952 paper [22] that chainable continua can always be embedded in the plane. We can simply construct such embeddings as nested intersections of chains which follow the patterns prescribed by bonding maps. There is a substantial amount of freedom in this construction, which enables us to push some points "out", making them accessible. That can be done for points which are not contained in *zigzags* of bonding maps (see Definition 5.13). In Chapter 5 (results are contained in paper [6]) we construct different planar embeddings of chainable continua. We show that the provided technique constructs all *thin embeddings* of chainable continua in the plane, *i.e.*, for which there exist arbitrary small planar chain covers with *connected* links. This enables us to give a partial answer to the Nadler-Quinn problem. We show the following.

Theorem 1.7. *If $X = \varprojlim \{I, f_n\}$, where f_n are continuous and piecewise linear, and if $x = (\dots, x_{-2}, x_{-1}, x_0) \in X$ is such that x_{-n} is not contained in a zigzag of f_n for all $n \geq 1$, then X can be embedded in the plane such that x is accessible.*

The Nadler-Quinn problem is still open in full generality. We show that every point of Nadler's original candidate for a counterexample can be embedded accessibly, see Example 5.24. It is commonly believed that there should exist a counterexample (see Minc's candidate in Figure 5.16) to Nadler and Quinn's problem. It would be interesting to see if point p from Minc's map in Figure 5.16 can be embedded accessibly and when it is possible to embed zigzag points accessibly in general (having the pseudo-arc in mind).

Another problem of interest in this context is the following.

Question 1.8 (Mayer 1983). *Are there uncountably many non-equivalent planar embeddings of every indecomposable chainable continuum?*

There is no unique definition of equivalence of embeddings in the literature. Throughout this thesis we say that embeddings $\varphi, \psi: X \rightarrow \mathbb{R}^2$ are *equivalent* if the homeomorphism $\varphi \circ \psi^{-1}$ can be extended to a homeomorphism of the plane. Using that definition, we give a positive answer to Mayer's question. The main tool we use is Mazurkiewicz' theorem (Theorem 5.33), which states that the number of composants of planar X which are accessible in more than a point is at most countable. The main theorem is:

Theorem 1.9. *Every chainable continuum which contains an indecomposable subcontinuum can be embedded in the plane in uncountably many (strongly) non-equivalent ways.*

The question is still open for hereditarily decomposable continua, *i.e.*, continua for which every subcontinuum is decomposable. We know that the arc has a unique embedding, but already the $\sin \frac{1}{x}$ -curve has uncountably many (proved by Mayer in [67]). A hereditarily decomposable continuum which is particularly of interest is the inverse limit of the logistic map at the Feigenbaum parameter.

There is a weaker definition of equivalence which commonly appears in the literature. In that case we say that $\varphi, \psi: X \rightarrow \mathbb{R}^2$ are equivalent if there exists a homeomorphism $h: \varphi(X) \rightarrow \psi(X)$ which can be extended to a

homeomorphism of the plane. We note that Mayer's question is still open in this case. A positive answer was only obtained in the case of the pseudo-arc (see Lewis [62]) and unimodal inverse limits X_s with $s > 1$ (see [5]). In the course of the thesis we suggest possible paths towards a full generalization.

Short outline of the thesis

In Chapter 2 we give basic definitions and results on chainable continua and inverse limit spaces. We also give basic dynamical properties of the tent family since they will play a crucial role in the study of topological properties of spaces X_s later. The symbolic description of the dynamics of maps T_s is given in two (equivalent) ways; the *Milnor-Thurston kneading theory* and the *Hofbauer tower* construction. Both techniques are extended to spaces X_s in Chapter 3 and heavily used in the rest of our study.

In Chapter 3 we study the local and global topological properties of spaces X_s . Section 3.4 is devoted to the structures of folding points culminating with a proof of Theorem 1.1. Section 3.5 gives symbolic characterization of arc-components.

In Chapter 4 we study the structure of the *complete sequence* $\{A_i\}$ of long link-symmetric arcs in \mathfrak{R} and show that it characterizes \mathfrak{R} in the case when the critical orbit is infinite and non-recurrent. That enables us to prove the Core Ingram Conjecture in this case, see Theorem 1.3.

In Chapter 5 we construct different planar embeddings of chainable continua. We introduce the notion of a zigzag and prove Theorem 1.7. We also give counterexamples to the converse of Theorem 1.7 and explain the main difficulty in obtaining the full answer to the Nadler-Quinn problem. The construction enables us to explore non-equivalent embeddings of chainable continua. We use the strong definition of equivalence and show Theorem 1.9. This chapter contains many open questions and possible paths towards their solutions.

Chapter 2

Preliminaries

In this chapter we give an overview of the basic notions used throughout the thesis. We introduce continua, some of their special properties, and relate them to the notion of an inverse limit space. Since the thesis will focus on the interval inverse limits (*i.e.*, chainable continua), they are given a special treatment. Furthermore, we introduce unimodal dynamical systems on the interval and some basic symbolic techniques, such as the Milnor-Thurston kneading theory [71] and Hofbauer towers [53].

2.1 Chainable continua

We will first introduce the notion of a continuum and focus on the basic properties of chainable continua.

Definition 2.1. *Continuum is a non-empty compact connected metric space. A subcontinuum of a continuum X is a subset of X which is itself a continuum. It is called proper if it does not equal X . The compositant of a point $x \in X$ is the union of all proper subcontinua of X which contain x .*

Definition 2.2. *The unit interval will be denoted by $I = [0, 1]$. An arc A is a space homeomorphic to I . Given a continuum X and $x \in X$, the arc-component \mathfrak{A}_x of x is the union of all arcs in X which contain x .*

In the next example we introduce continua, other than the arc, which will commonly appear in our study.

Example 2.3. The $\sin \frac{1}{x}$ continuum is a space homeomorphic to the closure of the graph of $\sin \frac{1}{x}$ on $(0, 1]$. It consists of an arc and a ray compactifying on it. A ray is a continuous one-to-one image of $[0, \infty)$. More generally, an *Elsa* continuum is a continuum consisting of an arc and a ray compactifying on it. The terminology *Elsa continuum* was introduced by Sam Nadler in [77] (after his wife).

Definition 2.4. A continuum is called indecomposable if it cannot be represented as a union of two of its proper subcontinua.

Remark 2.5. Decomposable continuum X can have either one or three composants. Precisely, if X is not irreducible, i.e., if for every pair $p, q \in X$ there exists a proper subcontinuum of X containing both p and q , then the component of every point equals X . If there is a pair of points p, q which are not contained in a proper subcontinuum of X , then there exist three composants, namely, $\kappa(p) = \{x \in X : \text{there is a proper subcontinuum of } X \text{ containing } p \text{ and } x\}$, $\kappa(q) = \{x \in X : \text{there is a proper subcontinuum of } X \text{ containing } q \text{ and } x\}$, and the whole X , see [76], Theorem 11.13. For example, an arc $I = [0, 1]$ has three composants: $[0, 1)$, $(0, 1]$, and I . In the next theorem we see that the component structure is much more interesting for indecomposable continua.

Theorem 2.6 ([52], Theorems 3-44, 3-46, 3-47). An indecomposable continuum X contains uncountably many pairwise disjoint composants and each is dense in X .

Definition 2.7. A chain in a metric space X is a set $\mathcal{C} = \{\ell_1, \dots, \ell_n\}$ of open subsets of X called links, such that $\ell_i \cap \ell_j \neq \emptyset$ if and only if $|i - j| \leq 1$. The mesh of \mathcal{C} is defined as $\text{mesh}(\mathcal{C}) := \max_{i \in \{1, \dots, n\}} \text{diam}(\ell_i)$. Denote by $\mathcal{C}^* := \cup_{i \in \mathbb{N}} \ell_i$. We say that a continuum X is chainable if for every $\varepsilon > 0$ there exists a chain \mathcal{C} which covers X and such that $\text{mesh}(\mathcal{C}) < \varepsilon$.

Definition 2.8. Given metric spaces X and Y , a continuous map $f: X \rightarrow Y$ is called an ε -map if $\text{diam}(f^{-1}(f(x))) < \varepsilon$ for every $x \in X$. A continuum X is called arc-like if for every $\varepsilon > 0$ there exists an ε -map $f: X \rightarrow I$.

Theorem 2.9 ([76], Theorem 12.11). A continuum is chainable if and only if it is arc-like.

Definition 2.10. We say that $\mathcal{C}' = \{\ell'_1, \dots, \ell'_m\}$ refines \mathcal{C} and write $\mathcal{C}' \prec \mathcal{C}$ if for every $j \in \{1, \dots, m\}$ there exists $i \in \{1, \dots, n\}$ such that $\ell'_j \subset \ell_i$. If $\mathcal{C}' \prec \mathcal{C}$, then we define the pattern of \mathcal{C}' in \mathcal{C} as an ordered m -tuple $\text{Pat}(\mathcal{C}', \mathcal{C}) = (a_1, \dots, a_m)$ such that $\ell'_j \subset \ell_{a(j)}$ for every $j \in \{1, \dots, m\}$. If $\ell'_j \subset \ell_i \cap \ell_{i+1}$ we take $a(j) = i$, but that choice is made just for completeness.

Lemma 2.11. Let X and Y be compact metric spaces and let \mathcal{C}_n and \mathcal{D}_n be chain covers of X and Y respectively such that $\mathcal{C}_{n+1} \prec \mathcal{C}_n$, $\mathcal{D}_{n+1} \prec \mathcal{D}_n$ and $\text{Pat}(\mathcal{C}_{n+1}, \mathcal{C}_n) = \text{Pat}(\mathcal{D}_{n+1}, \mathcal{D}_n)$ for all $n \in \mathbb{N}_0$. Assume also that $\text{mesh}(\mathcal{C}_n) \rightarrow 0$, $\text{mesh}(\mathcal{D}_n) \rightarrow 0$ as $n \rightarrow \infty$. Then $X = \bigcap_{n \in \mathbb{N}_0} \mathcal{C}_n^*$ and $Y = \bigcap_{n \in \mathbb{N}_0} \mathcal{D}_n^*$ are homeomorphic.

Proof. Denote by $\mathcal{C}_k = \{\ell_1^k, \dots, \ell_{n(k)}^k\}$ and $\mathcal{D}_k = \{L_1^k, \dots, L_{n(k)}^k\}$ for all $k \in \mathbb{N}_0$. Let $x \in X$. Then $x = \bigcap_{k \in \mathbb{N}_0} \ell_{i(k)}^k$ for some $\ell_{i(k)}^k \in \mathcal{C}_k$ such that $\ell_{i(k)}^k \subset \ell_{i(k-1)}^{k-1}$ for every $k \in \mathbb{N}$.

Define $h: X \rightarrow Y$ as $h(x) := \bigcap_{k \in \mathbb{N}_0} L_{i(k)}^k$. Since the patterns agree and diameters tend to zero, this map is a well defined bijection. We show that it is continuous. First note that $h(\ell_{i(m)}^m) = L_{i(m)}^m$ for every $m \in \mathbb{N}_0$ and every $i(m) \in \{1, \dots, n(m)\}$, since if $x = \bigcap_{k \in \mathbb{N}_0} \ell_{i(k)}^k \subset \ell_{i(m)}^m$, then there is $k' \in \mathbb{N}_0$ such that $\ell_{i(k)}^k \subset \ell_{i(m)}^m$ for all $k \geq k'$. But then $L_{i(k)}^k \subset L_{i(m)}^m$ for all $k \geq k'$, thus $h(x) = \bigcap_{k \in \mathbb{N}_0} L_{i(k)}^k \subset L_{i(m)}^m$. The other direction follows similarly. Now let $U \subset Y$ be an open set and $x \in h^{-1}(U)$. Since diameters tend to zero, there is $m \in \mathbb{N}_0$ and $i(m) \in \{1, \dots, n(m)\}$ such that $h(x) \in L_{i(m)}^m \subset U$ and thus $x \in \ell_{i(m)}^m \subset h^{-1}(U)$. So $h^{-1}(U) \subset X$ is open and that concludes the proof. \square

We note that the previous lemma holds in a more general setting, *i.e.*, for graph-like continua and graph chains once the pattern is well defined, see [69].

Corollary 2.12 (See also [22]). *Every chainable continuum can be embedded in the plane.*

The precise construction of an embedding from the previous Corollary (actually, of many different embeddings) will be given in Chapter 5. For now

we only mention that the construction will use nested intersections of planar chains whose links are discs in the plane. Lemma 2.11 shows that we get the space homeomorphic to the chosen chainable continuum X if the constructed chains follow the prescribed patterns.

2.2 Inverse limit spaces

The notion of a chainable continuum is equivalent to the notion of an inverse limit on intervals. In this section we define an inverse limit space and give some basic results, focusing on the interval inverse limits.

Definition 2.13. *Let $(X_n)_{n \in \mathbb{N}_0}$ be a sequence of continua and let $f_n: X_n \rightarrow X_{n-1}$ be a continuous function for every $n \in \mathbb{N}$. The inverse limit of pair (X_n, f_n) is the space*

$$X = \varprojlim \{X_n, f_n\} := \{(\dots, x_{-1}, x_0) : f_n(x_{-n}) = x_{-n+1}, n \in \mathbb{N}\} \subset \prod_{n \in \mathbb{N}_0} X_n,$$

equipped with the standard product topology, i.e., the smallest topology in which the projections $\pi_n: X \rightarrow X_n$, $\pi_n((\dots, x_{-2}, x_{-1}, x_0)) := x_{-n}$ are continuous.

Remark 2.14. *Note that the countable product (with product topology) of metric spaces is metrizable. Moreover, note that $X = \bigcap_{m \in \mathbb{N}_0} Z_m$, where $Z_m = \{(\dots, x_{-1}, x_0) \in X : f_n(x_{-n}) = x_{-n+1}, \text{ for all } n \leq m\}$. Since (Z_m) is a nested sequence of compact and connected spaces, X is a non-degenerate continuum. Details are given in [55].*

Remark 2.15. *For $n < m$ denote by $f_n^m := f_{n+1} \circ f_{n+2} \circ \dots \circ f_m: X_m \rightarrow X_n$. If f_n are not surjections, we can replace every X_n by $Y_n = \bigcap_{m > n} f_n^m(X_m)$. Then $X = \varprojlim \{Y_n, f_n\}$ and $f_n|_{Y_n}$ is a surjection. So in the rest of the text we assume that all bonding maps are surjections.*

The next theorem gives necessary and sufficient conditions on two inverse limits to be homeomorphic.

Theorem 2.16 (Mioduszewski, [74]). *Continua $\varprojlim \{X_i, f_i\}$ and $\varprojlim \{Y_i, g_i\}$ are homeomorphic if and only if for every sequence of positive numbers $\varepsilon_i \rightarrow 0$*

there exist sequences of strictly increasing integers (n_i) and (m_i) , and an infinite diagram as in Figure 2.1, such that every subdiagram as in Figure 2.2

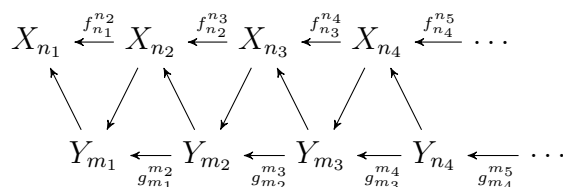

Figure 2.1: Infinite (ε_i) -commutative diagram from Mioduszewski's theorem.

is ε_i -commutative.

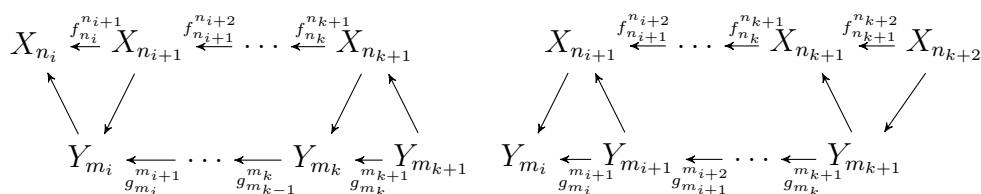

Figure 2.2: Subdiagrams which are ε_i -commutative for every $i \in \mathbb{N}$.

Corollary 2.17 (see also [55], Theorem 166). *Let $(n_i)_{i \in \mathbb{N}}$ be a sequence in \mathbb{N} and denote by $g_i = f_{n_i}^{n_{i+1}}$ for $i \in \mathbb{N}$. Then $\varprojlim \{X_i, f_i\}$ and $\varprojlim \{X_{n_i}, g_i\}$ are homeomorphic.*

The next theorem gives necessary and sufficient conditions on the indecomposability of an inverse limit.

Theorem 2.18 (Kuykendall, [60]). *Suppose $\{X_i, f_i\}$ is an inverse sequence such that each X_i is a continuum and each f_i is a continuous surjection. Then $X = \varprojlim \{X_i, f_i\}$ is indecomposable if and only if for every $n \in \mathbb{N}$ and every $\varepsilon > 0$ there exists $m > n$ and three points of X_m such that if K is a subcontinuum of X_m containing two of them, then $d_n(x, f_n^m(K)) < \varepsilon$ for every $x \in X_n$ (here d_n denotes the metric on X_n).*

In the rest of the thesis we focus on the inverse limits on intervals. Without loss of generality we can take all factor spaces to be $I = [0, 1]$ and $f_i: I \rightarrow I$

continuous surjections. Actually, by Mioduszewski's theorem, every f_i can be taken piecewise linear. We will use the following metric on I^∞ :

$$d((\dots, x_{-2}, x_{-1}, x_0), (\dots, y_{-2}, y_{-1}, y_0)) = \sum_{n \in \mathbb{N}_0} \frac{|x_{-n} - y_{-n}|}{2^n}.$$

This metric induces the standard product topology. The space I^∞ equipped with the product topology is called the *Hilbert cube*. The following theorem relates the notion of an inverse limit with the notion of a chainable continuum.

Theorem 2.19 ([76], Theorem 12.19). *A continuum is arc-like if and only if it is an inverse limit on arcs with onto bonding maps.*

Thus, a continuum is chainable if and only if it is an inverse limit on intervals. In Remark 2.21 we construct *natural chains* for every inverse limit on intervals.

Remark 2.20. *If $S \subset X$ is a set, by \bar{S} we will denote its closure. Also, for $S = \{S_1, \dots, S_n\}$ we denote by $S^* = \cup_{i=1}^n S_i$.*

Remark 2.21 (Construction of natural chains). *Let $X = \varprojlim \{I, f_i\}$, where $f_i: I \rightarrow I$ are continuous surjections. We show that X is chainable by constructing the natural chains. See Figure 2.3.*

Take some chain $C_0 = \{l_1^0, \dots, l_{k(0)}^0\}$ in I which covers I and define $\pi_0^{-1}(C_0) =: \mathcal{C}_0 = \{\ell_1^0, \dots, \ell_{k(0)}^0\}$, where $\ell_i^0 = \pi_0^{-1}(l_i^0)$. Note that \mathcal{C}_0 is an open cover of X and a chain in X .

Now take a chain $C_1 = \{l_1^1, \dots, l_{k(1)}^1\}$ cover of I such that for every $j \in \{1, \dots, k(1)\}$ there exists $j' \in \{1, \dots, k(0)\}$ such that $f_1(\bar{l}_j^1) \subset l_{j'}^0$, and define $\mathcal{C}_1 := \pi_1^{-1}(C_1)$. Note that \mathcal{C}_1 is a chain cover of X . Also note that $\mathcal{C}_1 \prec \mathcal{C}_0$ and $\text{Pat}(\mathcal{C}_1, \mathcal{C}_0) = \{a_1^1, \dots, a_{k(1)}^1\}$ where $f_1(\pi_1(\ell_j^1)) \subset \pi_0(\ell_{a_j^1}^0)$ for all $j \in \{1, \dots, k(1)\}$.

Inductively we construct $\mathcal{C}_{n+1} = \{\ell_1^{n+1}, \dots, \ell_{k(n+1)}^{n+1}\} := \pi_{n+1}^{-1}(C_{n+1})$, where $C_{n+1} = \{l_1^{n+1}, \dots, l_{k(n+1)}^{n+1}\}$ is some chain of I such that for every $j \in \{1, 2, \dots, k(n+1)\}$ there exists $j' \in \{1, \dots, k(n)\}$ such that $f_{n+1}(\bar{l}_j^{n+1}) \subset l_{j'}^n$. Note that $\mathcal{C}_{n+1} \prec \mathcal{C}_n$ and $\text{Pat}(\mathcal{C}_{n+1}, \mathcal{C}_n) = (a_1^{n+1}, \dots, a_{k(n+1)}^{n+1})$, where $f_{n+1}(\pi_{n+1}(\ell_j^{n+1})) \subset \pi_n(\ell_{a_j^{n+1}}^n)$ for all $j \in \{1, \dots, k(n+1)\}$.

Note that links of C_n can be chosen small enough to ensure that $\text{mesh}(C_n) \rightarrow 0$ as $n \rightarrow \infty$ and note that $X = \bigcap_{n \in \mathbb{N}_0} C_n^*$.

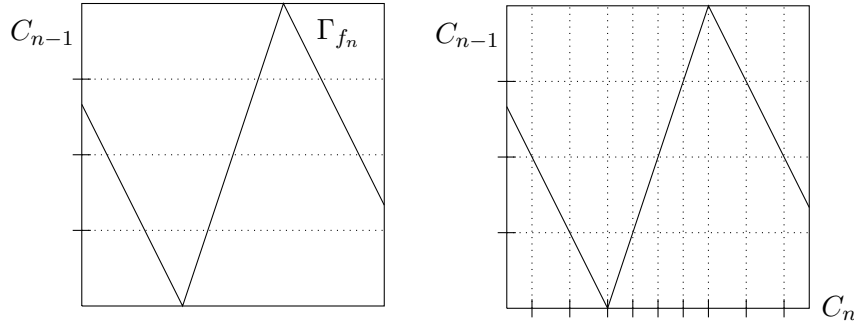

Figure 2.3: Construction of natural chains. For simplicity, in the picture the links of C_n are taken to be closed segments with a common boundary point.

Many chainable continua are inverse limits with a single bonding map $f: I \rightarrow I$. Such inverse limits will be denoted by $\varprojlim\{I, f\}$. The important property of the inverse limit space with a single bonding map is the existence of the *shift homeomorphism*. It is defined as $\sigma: \varprojlim\{I, f\} \rightarrow \varprojlim\{I, f\}$,

$$\sigma((\dots, x_{-2}, x_{-1}, x_0)) := (\dots, x_{-2}, x_{-1}, x_0, f(x_0)).$$

The dynamical system $(\varprojlim\{I, f\}, \sigma)$ is the smallest invertible extension of (I, f) and is easily analyzed. The spaces $\varprojlim\{I, f\}$ occur as global attractors of planar homeomorphisms (see [17], [25]). Thus the dynamics on the attractor can be easily understood in terms of (I, f) , which is a great advantage. Moreover, for many systems the dynamics on the global attractor can be obtained as a shift on an inverse limit on some simple space; *e.g.* on a branched 1-manifold for hyperbolic systems, see [85, 86], on the interval for certain parameters in the Hénon family, see [15], or on a finite tree for some simple pruned horseshoes, see [39].

We cite one more important theorem which will be often used. Although it is stated for inverse limits with a single bonding map, it can easily be generalized to more bonding maps. We will not need such generality. The theorem was

originally proven in a weaker form by Bennett in [21] and generalized by Ingram in [55].

Theorem 2.22. [Bennett, [55], Theorem 19] Assume $f: I \rightarrow I$ is onto and there exists $c \in (0, 1)$ such that $f([c, 1]) \subset [c, 1]$, $f|_{[0, c]}$ is monotone and there exists $n \in \mathbb{N}$ such that $f^n([0, c]) = I$. Then $\varprojlim\{I, f\}$ is a closure of a topological ray R (continuous one-to-one image of $[0, \infty)$) and $\overline{R} \setminus R = \varprojlim\{[c, 1], f|_{[c, 1]}\}$.

Example 2.23. Let $f: I \rightarrow I$ be as in Figure 2.4. Note that $\varprojlim\{[\frac{1}{2}, 1], f|_{[\frac{1}{2}, 1]}\}$ is an arc. Bennett's theorem implies that $\varprojlim\{I, f\}$ is an Elsa continuum. Actually, it is easy to prove that $\varprojlim\{I, f\}$ is the $\sin \frac{1}{x}$ -continuum, see Example 16 in [55].

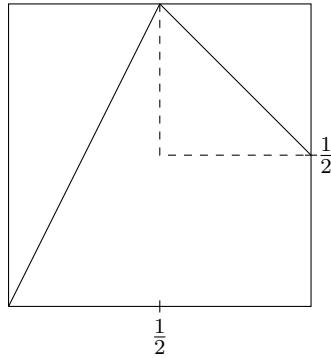

Figure 2.4: Map f from Example 2.23.

For the end of this section we note that there are examples of chainable continua which cannot be represented as an inverse limit with a single bonding map, see [64], [65]. However, it can be shown that every chainable continuum can be represented as an inverse limit with two bonding maps, see [87].

2.3 Dynamics of unimodal interval maps

Definition 2.24. By a dynamical system we mean a pair (X, f) , where X is a compact metric space and $f: X \rightarrow X$ is (piecewise) continuous. For $n \in \mathbb{N}$

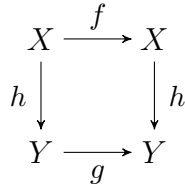

Figure 2.5: Topological (semi)-conjugacy of f and g .

denote by $f^n := f \circ f \circ \dots \circ f$ (n times). The forward orbit of $x \in X$ is

$$\text{Orb}(x) := \{x, f(x), f^2(x), f^3(x), \dots\}.$$

The ω -limit set of x is a set of limit points of $\text{Orb}(x)$, i.e.,

$$\omega(x, f) = \{y \in X : \text{there exists an increasing } (n_i)_{i \in \mathbb{N}}, f^{n_i}(x) \rightarrow y \text{ as } i \rightarrow \infty\}.$$

We say that x is periodic if there exists $n \in \mathbb{N}$ such that $f^n(x) = x$. The smallest such $n \in \mathbb{N}$ is called the prime period of x . If x has period one, it is called a fixed point. If x is not periodic but there exists $m \in \mathbb{N}$ such that $f^m(x)$ is periodic of (prime) period n , then x is called preperiodic with period n . If $x \in \omega(x)$, then x is called recurrent.

Definition 2.25. Let (X, f) and (Y, g) be dynamical systems. We say that systems (or maps f, g) are topologically conjugate if there exists a homeomorphism $h: X \rightarrow Y$ such that $h \circ f = g \circ h$. Such h is called a topological conjugacy of f and g . If h can be taken at most continuous and surjective, systems are topologically semi-conjugate and g is called a factor of f . See Figure 2.5.

We will be interested in dynamical properties of systems (I, f) , where $I = [0, 1]$ and $f: I \rightarrow I$ is unimodal, defined below.

Definition 2.26. We say that $f: I \rightarrow I$ is unimodal if

- (a) f is continuous,
- (b) there exists a unique local maximum $c \in (0, 1)$, i.e., $f|_{[0,c]}$ is strictly increasing, $f|_{[c,1]}$ is strictly decreasing,

(c) $f(0) = f(1) = 0$.

Example 2.27. Typical families of unimodal maps are

(a) The *logistic family* $f_a(x) = ax(1 - x)$, $a \in (0, 4]$.

(b) The *tent family* $T_s(x) = \min\{sx, s(1 - x)\}$, $s \in (0, 2]$.

(c) The *sine family* $S_\alpha(x) = \alpha \sin(\pi x)$, $\alpha \in (0, 1]$.

See Figure 2.6. Note that every unimodal map has a fixed point 0.

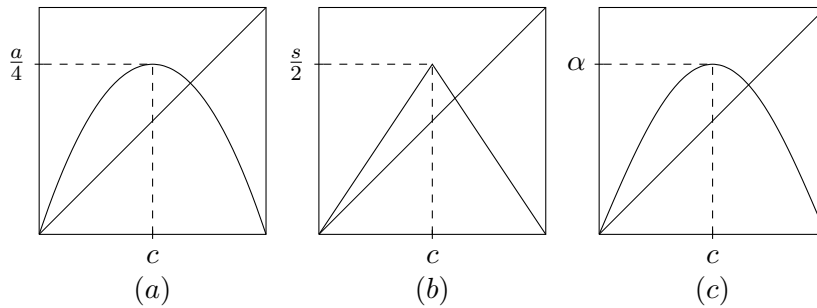

Figure 2.6: Graphs of (a) f_3 , (b) $T_{1.5}$, (c) $S_{0.75}$.

In the rest of the thesis we will be studying inverse limits with a single unimodal map, most often taken from the tent family. This is not such a drastic restriction as it may appear. Namely, it turns out that every unimodal map of positive topological entropy is topologically semi-conjugate to the tent map of the same entropy [71] and unimodal maps with entropy zero are renormalizable and the return map is again unimodal. In the remainder of this subsection we will define the notions of *renormalization* and *wandering intervals*. Every non-infinitely renormalizable unimodal map with no wandering intervals and no attracting periodic orbits is topologically conjugate to a tent map, see [70].

Definition 2.28. We say that a periodic orbit $\text{Orb}(x)$ of period n is attracting if there exists an open set $U \ni x$ such that for every $y \in U$ it holds that $f^{ni}(y) \rightarrow x$ as $i \rightarrow \infty$.

Definition 2.29. We say that $J \subset I$ is a wandering interval for f if $J, f(J), f^2(J), \dots$ are all disjoint and no point of J is attracted to an attracting periodic orbit.

Definition 2.30. Unimodal map f is called renormalizable if there exists a closed interval $J \subset I$ and $n \geq 2$ such that

- (i) $f^n(J) \subset J$
- (ii) $J, f(J), \dots, f^{n-1}(J)$ have disjoint interiors
- (iii) J contains c in its interior.

Interval J is called a restrictive interval of period n and $f^n|_J: J \rightarrow J$ is called the return map or renormalization of f to J . If the renormalization is again renormalizable, we say that f is twice renormalizable. This way we can define n -renormalizable maps for every $n \in \mathbb{N}$ and also infinitely renormalizable maps.

Infinite renormalization does not occur in the tent family, but it does in the logistic family. The famous example is the *Feigenbaum map*, i.e., logistic map with (Feigenbaum parameter) $a = 0.892486418\dots$. Actually, the only dynamical phenomena which make the logistic family richer than the tent family are the existence of attracting periodic orbits and the infinite renormalization. Those phenomena have simple topological consequences in the inverse limit spaces, see e.g. [10] or [29], justifying once again the restriction of our study to tent maps.

2.3.1 Tent map family

When the parameter $s > 1$ is understood, we denote $T_s^n(c) = c_n$ for all $n \in \mathbb{N}$. Let $r = \frac{s}{s+1}$ denote the fixed point of T_s in $(c, 1]$.

Remark 2.31. Behavior of orbits in the tent family is as follows:

- (i) For $s < 1$, for every point $x \in I$ it holds that $f^n(x) \rightarrow 0$ as $n \rightarrow \infty$, and 0 is the unique fixed point.

- (ii) For $s = 1$, every point $x \in [0, 1/2]$ is fixed and for every $y \in (1/2, 1]$ it holds that $f^2(y) \in [0, 1/2]$.
- (iii) For $s > 1$, the interval $[c_2, c_1]$ is invariant (called the dynamical core) and for every point $x \in (0, c_2)$ there exists $N \in \mathbb{N}$ such that $f^n(x) \in [c_2, c_1]$ for every $n \geq N$.
 - (a) If $1 < s \leq \sqrt{2}$, then T_s is renormalizable with restrictive interval $J = [c_2, r]$. Also $T_s(J) = [r, c_1]$ so every point in the core belongs either to J or its image. $T_s^2|_J$ is topologically conjugate to T_{s^2} . We conclude that if $\sqrt{2} < s^m \leq 2$ for some $m \geq 2$, then T_s is $m - 1$ times renormalizable. See Figure 2.7.
 - (b) If $\sqrt{2} < s \leq 2$, then T_s is locally eventually onto on the core, i.e., for every open $U \subset [c_2, c_1]$ there exists $n \in \mathbb{N}$ such that $T_s^n(U) = [c_2, c_1]$. Also, direct calculations give $c_3 < c_4$ and if $c_3 > c$, then $c_3 < r < c_4$. Specially, the smallest $\xi \geq 3$ such that $c_\xi \leq c$ is odd. Some other properties of T_s in this case will be discussed later.

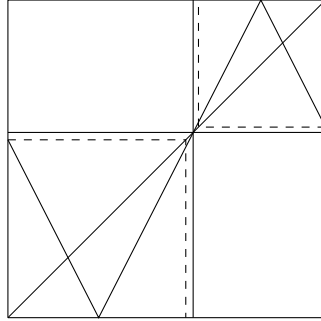

Figure 2.7: The graph of the map $T_s^2|_{[c_2, c_1]}$ where $s = 1.4 < \sqrt{2}$. Dashed lines denote the core of the renormalized map $T_s^2|_{[c_2, r]}$.

2.3.2 The Milnor-Thurston kneading theory for tent maps

In this section we present the Milnor-Thurston kneading theory [71] in a specific case when the piecewise linear interval map is a tent map T_s . We

will represent the points of the interval as a symbolic sequences (symbols will be chosen from the set $\{0, *, 1\}$) and the action of the chosen tent map will correspond to the symbolic shift. This theory was one of the major breakthroughs in the theory of dynamical systems on the interval. For example, in the original paper by Milnor and Thurston [71] it is proven that the topological entropy of the logistic family is monotone (which is still an open question for other unimodal families!) and the formula for the number of periodic orbits of unimodal maps was given. Later Guckenheimer [47] uses the symbolic description to study bifurcations in the unimodal family and the order in which periodic orbits appear. The phenomenon of renormalization in unimodal (and more general multimodal) families of interval maps was studied using the symbolic description in *e.g.* [41] and [70].

The symbolic coding can naturally be given in a greater generality. We restrict to tent maps mainly since the given symbolic coding will be one-to-one which makes the later analysis simpler. Moreover, the study of the topology of unimodal inverse limit spaces can, with the exception of infinitely renormalizable maps, be completely understood in the terms of tent map inverse limits. We come back to this in Chapter 3.

Assume $T = T_s$ is a tent map. To every $x \in [0, 1]$ we assign its *itinerary*:

$$i(x) := \nu_0(x)\nu_1(x)\dots,$$

where

$$\nu_i(x) := \begin{cases} 0, & T^i(x) \in [0, c), \\ *, & T^i(x) = c, \\ 1, & T^i(x) \in (c, 1]. \end{cases}$$

Note that if $\nu_i(x) = *$ for some $i \in \mathbb{N}_0$, then $\nu_{i+1}(x)\nu_{i+2}(x)\dots = i(c_1)$. The sequence $\nu := i(c_1)$ is called the *kneading sequence of T* and denoted by $\nu = \nu_1\nu_2\dots$. Observe that if $*$ appears in the kneading sequence, then c is periodic under T , *i.e.*, there exists $n > 0$ such that $c_n = c$ and the kneading sequence is of the form $\nu = (\nu_1\dots\nu_{n-1}*)^\infty$. In this case we adjust the kneading

sequence by taking the smallest of $(\nu_1 \dots \nu_{n-1} 0)^\infty$ and $(\nu_1 \dots \nu_{n-1} 1)^\infty$ in the parity-lexicographical ordering defined below.

By $\#_1(a_1 \dots a_n)$ we denote the number of ones in a finite word $a_1 \dots a_n \in \{0, 1\}^n$; it can be either even or odd.

Choose $t = t_1 t_2 \dots \in \{0, 1\}^\mathbb{N}$ and $s = s_1 s_2 \dots \in \{0, 1\}^\mathbb{N}$ such that $s \neq t$. Take the smallest $k \in \mathbb{N}$ such that $s_k \neq t_k$. Then the *parity-lexicographical ordering* is defined as

$$s \prec t \Leftrightarrow \begin{cases} s_k < t_k \text{ and } \#_1(s_1 \dots s_{k-1}) \text{ is even, or} \\ s_k > t_k \text{ and } \#_1(s_1 \dots s_{k-1}) \text{ is odd.} \end{cases}$$

This ordering is also well-defined on $\{0, *, 1\}^\mathbb{N}$ once we define $0 < * < 1$. Thus if $(\nu_1 \dots \nu_{n-1} 0)^\infty \prec (\nu_1 \dots \nu_{n-1} 1)^\infty$ we modify $\nu = (\nu_1 \dots \nu_{n-1} 0)^\infty$, otherwise $\nu = (\nu_1 \dots \nu_{n-1} 1)^\infty$.

In the same way we modify the itinerary of an arbitrary point $x \in [0, 1]$. If $\nu_i(x) = *$ and i is the smallest positive integer with this property then we replace $\nu_{i+1}(x)\nu_{i+2}(x)\dots$ with the modified kneading sequence. Thus $*$ can appear only once in the modified itinerary of an arbitrary point $x \in [0, 1]$.

From now onwards we assume that the itineraries of points from $[0, 1]$ are modified and use the same notation $i(x)$ for the modified itinerary of x .

It is a well-known fact (see [71]) that a kneading sequence completely characterizes the dynamics of unimodal map in the sense of the following proposition:

Proposition 2.32. *If $s_0 s_1 \dots \in \{0, *, 1\}^\mathbb{N}$ is the itinerary of a point $x \in [c_2, c_1]$, then*

$$i(c_2) \preceq s_k s_{k+1} \dots \preceq \nu = i(c_1), \text{ for every } k \in \mathbb{N}_0. \quad (2.1)$$

*Conversely, assume $s_0 s_1 \dots \in \{0, *, 1\}^\mathbb{N}$ satisfies (2.1). If there exists $j \in \mathbb{N}_0$ such that $s_{j+1} s_{j+2} \dots = \nu$, and j is minimal with this property, assume additionally that $s_j = *$. Then $s_0 s_1 \dots$ is realized as the itinerary of some $x \in [c_2, c_1]$.*

$$\begin{array}{ccc}
 I & \xrightarrow{T} & I \\
 i \downarrow & & \downarrow i \\
 S_{adm} & \xrightarrow{\sigma} & S_{adm}
 \end{array}$$

Figure 2.8: Equivalence of the system (I, T) and its symbolic model.

Definition 2.33. We say that a sequence $s_0s_1\dots \in \{0, *, 1\}^{\mathbb{N}}$ is admissible if it is realized as the itinerary of some $x \in [0, 1]$. Denote the set of all admissible sequences by S_{adm} .

Remark 2.34. Note that Proposition 2.32 gives conditions on admissible itineraries of points $x \in [c_2, c_1]$. For points $y \in [0, c_2) \cup (c_1, 1]$ admissible itineraries are exactly $0^{\mathbb{N}}, 10^{\mathbb{N}}, 0^j s_0 s_1 \dots, 10^{j-1} s_0 s_1 \dots$ where $s_0 s_1 \dots \in \{0, *, 1\}^{\mathbb{N}}$ is the itinerary of the point $T^j(y)$ which satisfies the conditions of Proposition 2.32 for $j := \min\{i \in \mathbb{N} : T^i(y) \in [c_2, c_1]\}$.

Remark 2.35. Note that if $s > 1$, then for every interval $[x, y] \subset I$ there exists $n \in \mathbb{N}$ such that $c \in T^n([x, y])$. Thus it follows that $x \mapsto i(x)$ is one-to-one. Actually, i is strictly increasing. Moreover, Proposition 2.32 implies that $i: I \rightarrow S_{adm}$ is surjective. Let $\sigma: S_{adm} \rightarrow S_{adm}$ denote the shift map $\sigma(s_0 s_1 s_2 \dots) = s_1 s_2 \dots$. Then the diagram in Figure 2.8 is commutative. Note, however, that i is not continuous in the preimages of c so it does not conjugate T and σ .

Remark 2.36. Note that for $s > 1$ the kneading sequence starts as $\nu = 10\dots$. If T is not renormalizable, then Remark 2.31 (iii) implies that $\nu = 10(11)^k 0\dots$, where $k \geq 0$.

The rest of the subsection is devoted to the admissibility conditions on tent map kneading sequences.

Definition 2.37. We say that $x = x_0 x_1 \dots$ is shift-maximal if $\sigma^k(x) \preceq x$ for every $k \in \mathbb{N}_0$.

Since c_1 is the maximum of T and i is increasing, it follows that ν is shift-maximal. In general, every shift-maximal sequence is realized as the kneading

sequence of some logistic map (which makes it a *full family*), see [47]. In order to give admissibility conditions on the kneading sequences of tent maps we still have to exclude renormalization. The symbolics of renormalization is captured in the definition of the star product introduced in [41].

Definition 2.38. *Let $A \in \{0, 1\}^m$ and let $B = B_0B_1 \dots \in \{0, 1\}^\infty$. Define the ***-product** as follows:*

$$A * B = \begin{cases} AB_0AB_1AB_2 \dots, & \text{if } \#_1(A) \text{ is even,} \\ AB_0^*AB_1^*AB_2^* \dots, & \text{if } \#_1(A) \text{ is odd, where } 0^* = 1, 1^* = 0. \end{cases}$$

*The definition remains the same if B is finite (then $A * B$ is finite). The sequence $s = A * B$ is called *renormalizable*. The sequence which is not renormalizable is called *primary*.*

Proposition 2.39 ([41], Lemma III.1.4 and Lemma III.1.6). *A non-periodic sequence $s = s_1s_2 \dots$ or a sequence $\nu = (\nu_1 \dots \nu_{n-1}^*)^\infty$ is the kneading sequence of some T_s for $s > \sqrt{2}$ if and only if $\nu \succ 101^\infty$ is shift-maximal and primary.*

Remark 2.40. *For $m \geq 2$ and $\sqrt{2} < s^m \leq 2$ the kneading sequence of T_s is of the form $1 * \nu$, where ν is the kneading sequence of T_{s^2} . See Remark 2.31 and [41].*

2.3.3 Hofbauer tower

In this section we introduce the Hofbauer tower of a unimodal map, see originally [53] and later [70] and [27]. It is a Markov extension of the original map and the orbits can be easily tracked by jumping up and down the tower. We will only introduce the basic notions needed later.

Let $s > 1$ and $T = T_s$ be a corresponding tent map. Closed intervals in \mathbb{R} will be denoted by $[a, b]$, also if we do not know whether $a < b$ or $b < a$.

The *Hofbauer tower* of T is a disjoint union of middle branches of T , *i.e.*,

$$\mathcal{H} = \bigsqcup_{n \in \mathbb{N}} D_n,$$

where $D_1 = [c_1, c]$ and

$$D_{n+1} = \begin{cases} T(D_n); & c \notin D_n, \\ [c_{n+1}, c_1]; & c \in D_n, \end{cases}$$

for every $n \in \mathbb{N}$. Note that if $a_n \in I$, $a_n < c$ denotes the point such that $[a_n, c]$ is the largest interval on which T^n is monotone, then $D_n = T^n([a_n, c])$ for every $n > 1$.

Note that one endpoint of D_n is always c_n for every $n \in \mathbb{N}$. If there exists $n \in \mathbb{N}$ such that $c = c_n$, then $c \in D_{n-1}$ so $D_n = [c_n, c_1] = D_1$, *i.e.*, the tower is periodic with period n .

If $c \in D_n$, then n is called a *cutting time*. Note that for $s > 1$ there are infinitely many cutting times. Denote by $(S_k)_{k \in \mathbb{N}_0}$ the strictly increasing sequence of all cutting times, where $S_0 = 1$. Note that for $s \geq 1$ we have $S_1 = 2$.

Denote by $\beta(n) := n - \max_{k \in \mathbb{N}_0} \{S_k : S_k < n\}$. Then $D_n = [c_n, c_{\beta(n)}]$ for every $n > 1$. Note that both $c_n < c_{\beta(n)}$ and $c_{\beta(n)} < c_n$ is possible.

Lemma 2.41 ([70], Lemma I.3.3). $D_k \subset D_{\beta(k)}$ for every $k > 1$.

Since $c \in D_{S_k} \subset D_{\beta(S_k)}$, we conclude that $\beta(S_k) = S_k - S_{k-1}$ is a cutting time. The map $Q: \mathbb{N}_0 \rightarrow \mathbb{N}_0$ given by $S_{Q(k)} := S_k - S_{k-1}$ is called the *kneading map* for f . For completeness we set $Q(0) = 0$. Note that $Q(k) = \infty$ is possible, in which case c is periodic. Further on we restrict to non-periodic cases.

Remark 2.42. Note that for every $k \in \mathbb{N}$

$$\nu_1 \dots \nu_{S_k} = \nu_1 \dots \nu_{S_{k-1}} \nu_1 \dots \nu_{S_{Q(k)}}^*.$$

Lemma 2.43. $\nu_1 \dots \nu_{S_k}$ has odd number of 1s for every $k \in \mathbb{N}$.

Proof. The claim is obviously true for $k = 0, 1$. Assume it is true for all $k < n$. Then $\nu_1 \dots \nu_{S_n} = \nu_1 \dots \nu_{S_{n-1}} \nu_1 \dots \nu_{S_n - S_{n-1} - 1} (1 - \nu_{S_n - S_{n-1}})$. Since $S_n - S_{n-1}$ is a cutting time, by the inductive assumption $\nu_1 \dots \nu_{S_n - S_{n-1} - 1} (1 - \nu_{S_n - S_{n-1}})$ is even. Also, $\nu_1 \dots \nu_{S_{n-1}}$ is odd and thus $\nu_1 \dots \nu_{S_n}$ is odd. \square

Proposition 2.44 ([34], Proposition 1). *The map $Q: \mathbb{N}_0 \rightarrow \mathbb{N}_0$ is realized as the kneading map of some tent map T_s , $s > \sqrt{2}$, with non-periodic critical point c , if and only if*

- (a) $\{Q(k+j)\}_{j \in \mathbb{N}} \succeq_L \{Q(Q^2(k)+j)\}_{j \in \mathbb{N}}$ for every $k \in \mathbb{N}$; where \preceq_L denotes the lexicographical order,
- (b) For every $K > 1$ such that $Q(K) = K - 1$ there is $k > K$ such that $Q(k) < K - 1$.

Proof. The condition (a) originates from Hofbauer's original work [53]. There he proves that the condition (a) is equivalent to Q being the kneading map of some logistic map (with no attracting periodic orbit). Assume that (a) and (b) hold. Thus Q is the kneading map of some logistic map with kneading sequence ν . If ν was renormalizable, it is of the form $\nu = AB_1AB_2AB_3 \dots$. If $B_i = B_1$ for every $i \in \mathbb{N}$, then ν is periodic, a contradiction. So there exists the smallest $i \in \mathbb{N}$ such that $B_1 \neq B_i$. Note that then both AB_1 and AB_1^* are admissible, so $|A| + 1$ must be a cutting time, denote it by $|A| + 1 = S_k$. Again since ν is not periodic, $S_{Q(k+1)} = |A| + 1 = S_k$ so $Q(k+1) = k$ and $Q(k+j) \geq k$ for every $j \in \mathbb{N}$, a contradiction. Conversely, assume that Q is a kneading map of some T_s , where $s > \sqrt{2}$ and c is not periodic. Then [53] implies that (a) is satisfied. Assume that (b) is not satisfied, so there is $K > 1$ such that $Q(K) = K - 1$ and $Q(k) \geq K - 1$ for every $k \in \mathbb{N}$. This immediately implies that ν is a renormalizable sequence of period S_{K-1} , which is a contradiction. \square

Remark 2.45. *There is a symbolically simpler condition equivalent to (a) defined in terms of co-cutting times, see [34]. However, co-cutting times will not be needed in the rest of the thesis.*

Example 2.46. It is not difficult to check that the following sequence is shift-maximal and primary and is thus the kneading sequence of some T_s for $s > \sqrt{2}$.

$$\nu = 1.0.0.11.101.11.10010.100111100.1001110110.100111011110011.1 \dots$$

Dots denote the cutting times, which are 1, 2, 3, 5, 8, 10, 15, 23, 33, 48, \dots . The kneading map is $Q(0) = Q(1) = Q(2) = 0$, $Q(3) = 1$, $Q(4) = 2$, $Q(5) = 1$, $Q(k) = k - 3$, for $k > 5$. The Hofbauer tower is given in Figure 2.9. Straightforward calculation shows that all conditions from Proposition 2.44 are also satisfied.

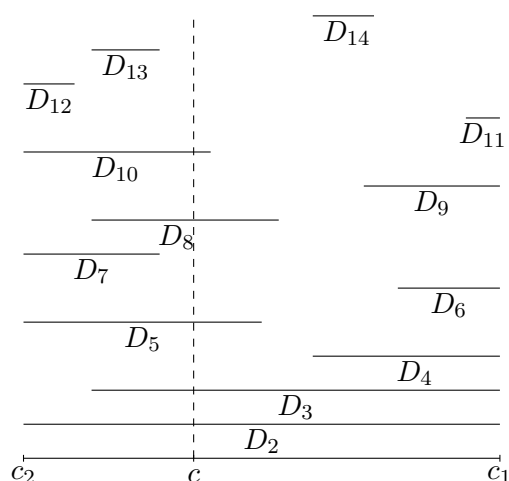

Figure 2.9: The Hofbauer tower for the kneading sequence given in Example 2.46.

Chapter 3

Unimodal inverse limit spaces

In this chapter we study the topological properties of unimodal inverse limit spaces, *i.e.*, spaces $\varprojlim\{I, f\}$ where f is unimodal. For simplicity we will restrict to tent maps, covering all but infinitely renormalizable unimodal maps, the structure of which is well-known, see [13]. In our study we use the extension of the Milnor-Thurston kneading theory, representing every point as a two-sided infinite sequence on two symbols, with certain identification points. We give a symbolic characterization of arc-components and discuss the structure of folding points, *i.e.*, points which do not have a neighbourhood homeomorphic to the Cantor set of open arcs. This study continues in Chapter 4, where we study the arc-component containing the fixed point in the core to obtain the partial classification of cores of tent inverse limits.

3.1 Definition and basic properties

We will be studying the topological properties of inverse limit spaces generated by a single bonding map from the tent family. Since every non-renormalizable unimodal map is semi-conjugate to some tent map, this can be directly applied to obtain topological properties of more general inverse limits generated by a single unimodal map.

Recall that the tent family is given by $T_s: I \rightarrow I$, $T_s(x) = \min\{sx, s(1-x)\}$, for $s \in [0, 2]$. The inverse limit space with a single bonding map T_s is given

by

$$X_s := \varprojlim \{[0, 1], T_s\}.$$

Recall the shift homeomorphism and natural chains introduced in Section 2.2. We list some properties of X_s . First note that T_s are not surjective for $s < 2$ so we restrict to the maximal interval on which T_s is surjective, which is $[0, c_1]$. From now on we always take $X_s = \varprojlim \{[0, c_1], T_s|_{[0, c_1]}\}$.

Remark 3.1. *Some of the basic properties of X_s are listed below:*

- (1) For $s < 1$, $X_s = \{(\dots, 0, 0)\}$.
- (2) For $s = 1$, X_s is an arc.
- (3) For $s > 1$, by Bennett's Theorem 2.22, the space X_s is the closure of a topological ray \mathfrak{C} and the remainder is the space

$$X'_s := \varprojlim \{[c_2, c_1], T_s|_{[c_2, c_1]}\},$$

called the core of X_s . Also, \mathfrak{C} contains the point $\bar{0} = (\dots, 0, 0)$ and it equals the arc-component of $\bar{0}$.

- (a) If $\sqrt{2} < s \leq 2$, then X'_s is indecomposable. Specifically, if $s = 2$, then $X_s = X'_s$ is the Knaster continuum.
- (b) If $1 < s \leq \sqrt{2}$, then X'_s is homeomorphic to two copies of X_{s^2} joined at the points which correspond to $\bar{0}$.

In the rest of the chapter we will often, without loss of generality, restrict to the case $s > \sqrt{2}$.

3.2 Symbolic description

In this section we give the extension of the Milnor-Thurston kneading theory to the spaces X_s from [29] and show how it can be used to study the topological properties. We give a symbolic characterization of arc-components in X_s and inhomogeneity points.

Chapter 3. Unimodal inverse limit spaces

We will show that the space X_s is homeomorphic to the space Σ_{adm}/\sim , where Σ_{adm} is the set of *admissible* two-sided infinite sequences in $\{0, 1\}^{\mathbb{Z}}$ and \sim is an equivalence relation obtained by replacing the symbol $*$ by both 0 and 1.

In this section we fix $s > \sqrt{2}$ and, when there is no confusion, denote X_s just by X . We show how the Milnor-Thurston construction from Subsection 2.3.2 can be expanded to describe the space X .

Take $x = (\dots, x_{-2}, x_{-1}, x_0) \in X$. Define the itinerary of x as a two-sided infinite sequence

$$I(x) := \dots \nu_{-2}(x) \nu_{-1}(x) \nu_0(x) \nu_1(x) \dots \in \{0, *, 1\}^{\mathbb{Z}},$$

where $\nu_0(x) \nu_1(x) \dots = i(x_0)$ and

$$\nu_i(x) = \begin{cases} 0, & x_i \in [0, c), \\ *, & x_i = c, \\ 1, & x_i \in (c, 1], \end{cases}$$

for all $i < 0$.

Remark 3.2. *To avoid unnecessary extra notation, we will often abuse the notation and write $I(x) = \dots x_{-2}x_{-1}.x_0x_1\dots$ instead of using $\nu_i(x)$. We also use $\overleftarrow{x} = \dots x_{-2}x_{-1}$ and $\overrightarrow{x} = x_0x_1\dots$ to denote the left and right infinite itineraries of x .*

If c is periodic, we make the same modifications as in Subsection 2.3.2. If $*$ appears for the first time at $\nu_k(x)$ for some $k \in \mathbb{Z}$, then $\nu_{k+1}(x) \nu_{k+2}(x) \dots = \nu$. If there is infinitely such k , then the kneading sequence is periodic with period $n \in \mathbb{N}$, $\nu = (\nu_1 \nu_2 \dots \nu_{n-1} *)^\infty$ and the itinerary of x is of the form $(\nu_1 \dots \nu_{n-1} *)^{\mathbb{Z}}$. Replace $(\nu_1 \dots \nu_{n-1} *)^{\mathbb{Z}}$ with the modified itinerary $(\nu_1 \nu_2 \dots \nu_{n-1} \nu_n)^{\mathbb{Z}}$, where $\nu = (\nu_1 \dots \nu_{n-1} \nu_n)^\infty$. In this way $*$ can appear at most once in every itinerary. Now we are ready to identify the inverse limit space with a quotient of a space of two-sided sequences consisting of two symbols.

Chapter 3. Unimodal inverse limit spaces

Let $\Sigma := \{0, 1\}^{\mathbb{Z}}$ be the space of two-sided sequences equipped with the metric

$$d((s_i)_{i \in \mathbb{Z}}, (t_i)_{i \in \mathbb{Z}}) := \sum_{i \in \mathbb{Z}} \frac{|s_i - t_i|}{2^{|i|}},$$

for $(s_i)_{i \in \mathbb{Z}}, (t_i)_{i \in \mathbb{Z}} \in \Sigma$. We define the shift homeomorphism $\sigma: \Sigma \rightarrow \Sigma$ as

$$\sigma(\dots s_{-2}s_{-1}.s_0s_1\dots) := \dots s_{-2}s_{-1}s_0.s_1\dots$$

By $\Sigma_{adm} \subseteq \Sigma$ we denote all $s \in \Sigma$ such that either

- (a) $s_k s_{k+1} \dots$ is admissible (*i.e.*, contained in S_{adm} , see Subsection 2.3.2) for every $k \in \mathbb{Z}$, or
- (b) there exists $k \in \mathbb{Z}$ such that $s_{k+1} s_{k+2} \dots = \nu$ and $s_{k-i} \dots s_{k-1} * s_{k+1} s_{k+2} \dots$ is admissible (contained in S_{adm}) for every $i \in \mathbb{N}$.

We abuse notation and call the two-sided sequences in Σ_{adm} also *admissible*.

Let us define an equivalence relation on the space Σ_{adm} . For sequences $s = (s_i)_{i \in \mathbb{Z}}, t = (t_i)_{i \in \mathbb{Z}} \in \Sigma_{adm}$ we define the relation

$$s \sim t \Leftrightarrow \begin{cases} \text{either } s_i = t_i \text{ for every } i \in \mathbb{Z}, \\ \text{or if there exists } k \in \mathbb{Z} \text{ such that } s_i = t_i \text{ for all } i \neq k \text{ but } s_k \neq t_k \\ \text{and } s_{k+1} s_{k+2} \dots = t_{k+1} t_{k+2} \dots = \nu. \end{cases}$$

It is not difficult to see that this is indeed an equivalence relation on the space Σ_{adm} . Furthermore, every itinerary is identified with at most one other itinerary and the quotient space Σ_{adm}/\sim of Σ_{adm} is well defined. In [29] it was shown that Σ_{adm}/\sim is homeomorphic to X . For all observations in this subsection we refer to the paper [29] of Brucks & Diamond (Lemmas 2.2–2.4 and Theorem 2.5).

3.3 Basic arcs

The space $X_s = \Sigma_{adm}/\sim$ can be represented as the union of arcs which we call *basic arcs*. Those arcs will be determined by a left-infinite sequence of

Chapter 3. Unimodal inverse limit spaces

0s and 1s. We give symbolic conditions which guarantee that two basic arcs have a common endpoint. The condition relates to the equivalence relation \sim and gives a symbolic characterization of endpoints of X_s .

We say that a left-infinite sequence $\dots s_{-2}s_{-1} \in \{0,1\}^{\mathbb{N}}$ is admissible if a finite word $s_{-k}\dots s_{-1}$ is admissible for every $k \in \mathbb{N}$.

Definition 3.3. Let $\overleftarrow{s} = \dots s_{-2}s_{-1}$ be an admissible left-infinite sequence. The basic arc determined by \overleftarrow{s} is defined as:

$$A(\overleftarrow{s}) := \{(t_i)_{i \in \mathbb{Z}} \in \Sigma_{adm} : t_i = s_i, i < 0\}.$$

Given an admissible \overleftarrow{s} , define two sets

$$\mathcal{L}(\overleftarrow{s}) := \{l \in \mathbb{N} : s_{-(l-1)} \dots s_{-1} = \nu_1 \dots \nu_{l-1}, \#_1(\nu_1 \dots \nu_{l-1}) \text{ odd}\},$$

$$\mathcal{R}(\overleftarrow{s}) := \{r \in \mathbb{N} : s_{-(r-1)} \dots s_{-1} = \nu_1 \dots \nu_{r-1}, \#_1(\nu_1 \dots \nu_{r-1}) \text{ even}\}.$$

Let $\tau_L(\overleftarrow{s}) := \sup \mathcal{L}$ and $\tau_R(\overleftarrow{s}) := \sup \mathcal{R}$ (we allow them to be infinite). When there is no confusion, we will often just write \mathcal{L} and \mathcal{R} .

Lemma 3.4 ([32], Lemma 2). Assume that $\tau_L(\overleftarrow{s}) < \infty$ and $\tau_R(\overleftarrow{s}) < \infty$. Then

$$\pi_0(A(\overleftarrow{s})) = [c_{\tau_L(\overleftarrow{s})}, c_{\tau_R(\overleftarrow{s})}].$$

If $\overleftarrow{t} \in \{0,1\}^{\mathbb{N}}$ is another admissible left-infinite sequence such that $s_i = t_i$ for all $i < 0$ except for $i = -\tau_R(\overleftarrow{s}) = -\tau_R(\overleftarrow{t})$ (or $i = -\tau_L(\overleftarrow{s}) = -\tau_L(\overleftarrow{t})$), then $A(\overleftarrow{s})$ and $A(\overleftarrow{t})$ have a common boundary point.

It is often useful to obtain basic arcs as nested intersections of levels of the Hofbauer tower. We will show how to do it in the following lemmas. Recall that $\beta(n) = n - \max\{S_k : S_k < n\}$ for every $n \in \mathbb{N}$.

Lemma 3.5. If $\#_1(\nu_1 \dots \nu_{n-1})$ is odd, then $c_n < c_{\beta(n)}$. If $\#_1(\nu_1 \dots \nu_{n-1})$ is even, then $c_n > c_{\beta(n)}$.

Proof. Note that $c_2 < c_{\beta(2)} = c_1$ and proceed inductively. Assume the claim holds for some $n \in \mathbb{N}$ and assume $\#_1(\nu_1 \dots \nu_n)$ is odd. If n is a cutting time,

Chapter 3. Unimodal inverse limit spaces

then $c_{n+1} < c_1 = c_{\beta(n+1)}$ and we are done. So assume n is not a cutting time. If $\#_1(\nu_1 \dots \nu_{n-1})$ is odd, then $c_n < c_{\beta(n)}$ and since $\nu_n = 0$, it follows that $c_n < c_{\beta(n)} < c$. So $c_{n+1} < c_{\beta(n)+1} = c_{\beta(n+1)}$. If $\#_1(\nu_1 \dots \nu_{n-1})$ is even, then $c_n > c_{\beta(n)} > c$ and thus $c_{n+1} < c_{\beta(n+1)}$. The case when $\#_1(\nu_1 \dots \nu_n)$ is even follows analogously once we note that n cannot be a cutting time using Lemma 2.43. \square

Lemma 3.6. *If $l < l' \in \mathcal{L}$, then $c_l < c_{l'}$. If $r < r' \in \mathcal{R}$, then $c_r > c_{r'}$.*

Proof. Fix $l < l' \in \mathcal{L}$. We will compare $\nu_l \nu_{l+1} \dots$ to $\nu_{l'} \nu_{l'+1} \dots$. Take the smallest $k \in \mathbb{N}_0$ such that $\nu_{l+k} \neq \nu_{l'+k}$. Note that $\nu_1 \dots \nu_{l'}$ ends in $\nu_1 \dots \nu_l$. So both $\nu_1 \dots \nu_l \nu_{l+1} \dots \nu_{l+k}$ and $\nu_1 \dots \nu_l \nu_{l+1} \dots (1 - \nu_{l+k})$ are admissible, that is $l+k$ is a cutting time. Thus $\#_1(\nu_1 \dots \nu_l \nu_{l+1} \dots \nu_{l+k})$ is odd by Lemma 2.43 so $\#_1(\nu_1 \dots \nu_{l+k})$ is even. If $\nu_{l+k} = 0$, then $\nu_1 \dots \nu_{l+k-1} = \nu_{l'} \dots \nu_{l'+k-1}$ is even and $\nu_1 \dots \nu_{l+k} < \nu_{l'} \dots \nu_{l'+k}$. So $c_l < c_{l'}$. If $\nu_{l+k} = 1$ the proof follows analogously. The proof for \mathcal{R} is also analogously. \square

Lemma 3.7. *If $l \in \mathcal{L}$, then $\beta(l) \in \mathcal{R}$. If $r \in \mathcal{R}$, then $\beta(r) \in \mathcal{L}$.*

Proof. Since $n - \beta(n)$ is a cutting time for every $n \geq 2$, then $\nu_1 \dots \nu_{n-\beta(n)}$ is odd. So $\nu_1 \dots \nu_{n-1} = \nu_1 \dots \nu_{n-\beta(n)} \nu_1 \dots \nu_{\beta(n)-1}$ and $\nu_1 \dots \nu_{\beta(n)-1}$ are of different parity. \square

Lemma 3.8. *If $l < l' \in \mathcal{L}$, then $D_l \supset D_{l'}$. If $r < r' \in \mathcal{R}$, then $D_r \supset D_{r'}$.*

Proof. Since $\nu_1 \dots \nu_{l'}$ ends in $\nu_1 \dots \nu_l$, if $l' - k$ is a cutting time, so is $l - k$, provided $l - k > 0$. Thus if $l < l' \in \mathcal{L}$, then $\beta(l) < \beta(l')$. The proof now follows directly from Lemma 3.5, Lemma 3.6 and Lemma 3.7. \square

Proposition 3.9.

$$\pi_0(A(\overleftarrow{s})) = \bigcap_{l \in \mathcal{L}} D_l \cap \bigcap_{r \in \mathcal{R}} D_r.$$

Proof. Note that the set on the right side of the equation is nested (Lemma 3.7 and Lemma 3.8) and thus non-empty. Arrange the sets $\mathcal{L} = \{l_1, l_2, \dots\}$ such that $l_1 < l_2 < \dots$ and $\mathcal{R} = \{r_1, r_2, \dots\}$ such that $r_1 < r_2 < \dots$ (can be both finite and infinite). Denote by $A_{l_i} = A(\dots 11\nu_1 \dots \nu_{l_i-1})$ and $A_{r_i} = A(\dots 11\nu_1 \dots \nu_{r_i-1})$ for every $i \in \mathbb{N}$. Note that the chosen left-infinite

sequences are admissible and thus A_{l_i} and A_{r_i} are basic arcs in the inverse limit. Also $\pi_0(A_{l_i}) = D_{l_i}, \pi_0(A_{r_i}) = D_{r_i}$ for every $i \in \mathbb{N}$, $D_{l_i}, D_{r_i} \supset \pi_0(A(\overleftarrow{s}))$ and $A_{l_i}, A_{r_i} \rightarrow A(\overleftarrow{s})$ as $i \rightarrow \infty$. This finishes the proof. \square

3.4 Inhomogeneities

We define folding points, endpoints, and give their symbolic characterization. Later we proceed with a more detailed classification.

Definition 3.10. *We say that $x \in X$ is a folding point if no (open) neighbourhood of x is homeomorphic to $C \times (0, 1)$, where C is the Cantor set. Since for $s < 2$ the ray \mathfrak{C} is isolated, every point in \mathfrak{C} is a folding point. The set of folding points of X' will be denoted by $\mathcal{F}_{X'}$, or just \mathcal{F} when there is no confusion.*

Definition 3.11. *A point $x \in X$ is called an endpoint if for every two subcontinua $X_1, X_2 \subset X$ such that $x \in X_1 \cap X_2$, either $X_1 \subset X_2$ or $X_2 \subset X_1$. Note the \mathfrak{C} contains a unique endpoint $\bar{0}$. The set of endpoints in X' will be denoted by $\mathcal{E}_{X'}$ or just \mathcal{E} .*

Remark 3.12. *Note that every endpoint is a folding point. The converse does not hold in general as we see in the rest of the section. We show that the converse holds if and only if the critical orbit is persistently recurrent, see Theorem 1.1.*

In the following propositions we give a well-known symbolic characterizations of folding points and endpoints.

Proposition 3.13. *[79, Theorem 2.2] A point $x \in X'$ is a folding point if and only if $\pi_n(x) \in \omega(c)$ for every $n \in \mathbb{N}$.*

Note that Proposition 3.13 implies that $\mathcal{F} = \varprojlim \{\omega(c), T|_{\omega(c)}\}$. Since $\omega(c)$ is compact, the set \mathcal{F} is also compact and non-empty. It also follows that $\mathcal{F} = X'$ if $\omega(c) = [c_2, c_1]$ and \mathcal{F} is nowhere dense if $\omega(c)$ is nowhere dense. So in the tent inverse limit \mathcal{F} is either nowhere dense or equal to X' .

Lemma 3.14. *If $\omega(c)$ is a Cantor set, then so is \mathcal{F} .*

Proof. Note that \mathcal{F} is compact. Also, since $\omega(c)$ is totally disconnected, then so is $\prod \omega(c)$ and consequently also \mathcal{F} . To see that \mathcal{F} has no isolated points, take $x = (\dots, x_{-2}, x_{-1}, x_0) \in \mathcal{F}$ and $\varepsilon > 0$. There exist $N \in \mathbb{N}$ and $\varepsilon' > 0$ small enough such that if $|x_{-N} - y_{-N}| < \varepsilon'$ for some $(\dots, y_{-2}, y_{-1}, y_0) \in X$, then $d(x, y) < \varepsilon$. Since $\omega(c)$ has no isolated points and $x_{-N} \in \omega(c)$, there exists $y_{-N} \in \omega(c)$ such that $|y_{-N} - x_{-N}| < \varepsilon'$. Note that $y_{-k} = f^{N-k}(y_{-N}) \in \omega(c)$ for every $k \in \{0, \dots, N\}$. Note also that for every $z \in \omega(c)$ there exists at least one $z' \in \omega(c)$ such that $T(z') = z$. We conclude that there exists $y = (\dots, y_{-N}, \dots, y_{-1}, y_0) \in \mathcal{F}$ such that $d(x, y) < \varepsilon$. \square

Clearly the number of folding points is uncountable if $\omega(c)$ is uncountable, but also when $\omega(c)$ is countable, it can happen that the set of folding points is uncountable. This is shown in [45], together with more interesting results on number of folding points. It is possible that X' has countably infinitely many folding points, see the following Example. However, the critical point will then be non-recurrent and there will be no endpoints, see Proposition 3.18.

Example 3.15 ([36], p.6). Let T be a tent map with kneading sequence

$$\nu = 1.0.0.11.0.11.11.0.11.11.11.0.11.11.11.11.0.11.11.11.11.11 \dots$$

Note that the critical point is non-recurrent. By Proposition 3.13 the only folding points have two-sided itinerary $\dots 1111\dots$ or $\dots 111101111\dots$, so \mathcal{F} is countable. Note also that $\mathcal{F} \cap X'$ has only isolated points, except for ρ .

In the next Proposition we give a symbolic characterization of endpoints.

Proposition 3.16. [32, Proposition 2] *Let $x \in X$ have the itinerary $I(x) = \dots x_{-2}x_{-1}.x_0x_1\dots$ and assume that $x_i \neq *$ for all $i < 0$. Then x is an endpoint of X if and only if $\tau_L(\overleftarrow{x}) = \infty$ and $x_0 = \inf \pi_0(A(\overleftarrow{x}))$ or $\tau_R(\overleftarrow{x}) = \infty$ and $x_0 = \sup \pi_0(A(\overleftarrow{x}))$.*

Note that x is an endpoint of X if and only if $\sigma^i(x)$ is an endpoint of X for every $i \in \mathbb{Z}$. So if $x_i = *$ for some $i < 0$ (and such i is unique in the modified itinerary of x), we can apply Proposition 3.16 to $\sigma^i(x)$.

Remark 3.17. *Note that Proposition 3.16 implies that if $A(\overleftarrow{x}) = \{x\}$ is degenerate, then x is an endpoint of X .*

We list the known structures of sets \mathcal{F} and \mathcal{E} with respect to the behavior of $Orb(c)$. Most of this facts are straightforward consequences of the symbolic characterization of folding points and endpoints. The aim of this section is to expand the results and obtain a more thorough understanding of spaces \mathcal{F} and \mathcal{E} .

- (i) If c is periodic of prime period $n \in \mathbb{N}$, then X' has n folding points and they are all endpoints. If $\nu = (\nu_1 \dots \nu_n)^\infty$, the symbolic representation of endpoints is $\sigma^i((\nu_1 \dots \nu_n)^\mathbb{Z})$ for $i \in \{0, 1, \dots, n-1\}$, see [18].
- (ii) If $\nu = \nu_1 \dots \nu_m (\nu_{m+1} \dots \nu_{m+n})^\infty$ where $\nu_m \neq \nu_{m+n}$, then X' has n folding points none of which is an endpoint. Their symbolic representation is given by $\sigma^i((\nu_{m+1} \dots \nu_{m+n})^\mathbb{Z})$ for $i \in \{0, 1, \dots, n-1\}$.
- (iii) If $Orb(c)$ is infinite and non-recurrent, then there exist infinitely many (can be both countable and uncountable) folding points and no endpoints, see [32].
- (iv) If $Orb(c)$ is infinite and recurrent and such that $\omega(c) \neq [c_2, c_1]$, then \mathcal{F} is a Cantor set and \mathcal{E} is uncountable, see [32] and Proposition 3.18.
- (v) If $\omega(c) = [c_2, c_1]$, then every point in X' is a folding point and the set of endpoints is dense in X' , see Proposition 3.18.

Proposition 3.18. *If $Orb(c)$ is infinite and c is recurrent, then the core inverse limit space X' has uncountably many endpoints. Moreover, $Cl(\mathcal{E}) = \mathcal{F}$ and \mathcal{E} has no isolated points.*

Proof. Since c is recurrent, for every $k \in \mathbb{N}$ there exist infinitely many $n \in \mathbb{N}$ such that $\nu_1 \dots \nu_n = \nu_1 \dots \nu_{n-k} \nu_1 \dots \nu_k$.

Take the sequence $(n_j)_{j \in \mathbb{N}}$ such that $\nu_1 \dots \nu_{n_{j+1}} = \nu_1 \dots \nu_{n_{j+1}-n_j} \nu_1 \dots \nu_{n_j}$ for every $j \in \mathbb{N}$. Then the basic arc given by the itinerary

$$\overleftarrow{x} := \dots \nu_1 \dots \nu_{n_j},$$

Chapter 3. Unimodal inverse limit spaces

for every $j \in \mathbb{N}$ (*i.e.*, the left-infinite sequence \overleftarrow{x} ends in $\nu_1 \dots \nu_{n_j}$ for every $j \in \mathbb{N}$), is admissible and $\tau_L(\overleftarrow{x}) = \infty$ or $\tau_R(\overleftarrow{x}) = \infty$. Therefore $A(\overleftarrow{x})$ contains an endpoint. Note that, since ν is not periodic, \overleftarrow{x} is also not periodic and thus $\sigma^k(\overleftarrow{x}) \neq \overleftarrow{x}$ for every $k \in \mathbb{N}$. So for a fixed $n \in \mathbb{N}$ it is possible to find $m_2 > m_1 > n$ (it is actually possible to find countably many of them) such that $\nu_1 \dots \nu_{m_2} = \nu_1 \dots \nu_{m_2-n} \nu_1 \dots \nu_n$, $\nu_1 \dots \nu_{m_1} = \nu_1 \dots \nu_{m_1-n} \nu_1 \dots \nu_n$, but $\nu_1 \dots \nu_{m_1}$ is not a suffix of $\nu_1 \dots \nu_{m_2}$. We conclude that for every n_j there are at least two choices of n_{j+1} such that the corresponding tails \overleftarrow{x} are different, and have $|\mathcal{L}(\overleftarrow{x}) \cup \mathcal{R}(\overleftarrow{x})| = \infty$. It follows that there are uncountably many basic arcs containing at least one endpoint.

To show that $\text{Cl}(\mathcal{E}) = \mathcal{F}$ (and contains no isolated point), take any folding point x with itinerary $\dots x_{-2}x_{-1}.x_0x_1x_2\dots$. Then for every $k \in \mathbb{N}$ there exists $n \in \mathbb{N}$ such that $x_{-k} \dots x_k = \nu_n \dots \nu_{n+2k}$. Using the arguments as above, we can find a basic arc with itinerary $\overleftarrow{y} = \dots \nu_1 \dots \nu_{n-1} \nu_n \dots \nu_{n+2k}$ and such that $\tau_L(A(\overleftarrow{y})) = \infty$ or $\tau_R(A(\overleftarrow{y})) = \infty$. So $\sigma^{-k}(A(\overleftarrow{y}))$ contains an endpoint with itinerary $\dots \nu_n \dots \nu_{n+k} \nu_{n+k+1} \dots \nu_{n+2k} \dots$. Since $k \in \mathbb{N}$ was arbitrary, we conclude that there is an endpoint arbitrarily close to x . \square

Next we study when $\mathcal{F} = \mathcal{E}$. Some partial results are known. Namely, $\mathcal{F} = \mathcal{E}$ when $Q(k) \rightarrow \infty$ and if $T|_{\omega(c)}$ is one-to-one, see [1]. However, there are examples which show that the converse does not hold [2]. Question of distinguishing endpoints within the set of folding points originated from the study of infinitely renormalizable unimodal maps f . There $f|_{\omega(c)}$ is conjugated to an adding machine [70] and $\mathcal{F} = \mathcal{E}$. However, having an embedded adding machine (which can also happen in non-renormalizable case, see [23] for the construction of strange adding machines) does not suffice [2]. Here we use the notion of persistent recurrence which shows to be crucial for classification of X for which $\mathcal{F} = \mathcal{E}$. Persistent recurrence was first introduced in [63] in the context of wild attractors of unimodal interval maps.

Definition 3.19. *Let $x = (\dots, x_{-1}, x_0) \in X$ and let $J \subset [0, 1]$ be an interval. The sequence $(J_n)_{n \in \mathbb{N}_0}$ of intervals is called a pull-back of J along x if $J = J_0$, $x_{-k} \in J_k$ and J_{k+1} is the largest interval such that $T(J_{k+1}) \subset J_k$ for all $k \in \mathbb{N}_0$. A pull-back is monotone if $c \notin \text{Int}(J_n)$ for every $n \in \mathbb{N}$.*

Chapter 3. Unimodal inverse limit spaces

Lyubich [63] gave the following definition of persistent recurrence for the case when c is recurrent:

Definition 3.20. *The critical point c is reluctantly recurrent if there is $\varepsilon > 0$ and an arbitrary long (but finite!) backward orbit $\bar{x} = (x, x_{-1}, \dots, x_{-l})$ in $\omega(c)$ such that the ε -neighborhood of x has monotone pull-back along \bar{x} . Otherwise, c is persistently recurrent.*

Remark 3.21. *The following lemma shows that one can replace arbitrarily finite pull-backs by infinitely long pull-backs, and this allows us to interpret reluctant recurrence as: there exist a folding point $x = (\dots, x_{-1}, x_0) \in X'$, an interval J such that $x_0 \in \text{Int}(J)$, and a monotone pull-back of J along x .*

Lemma 3.22. *Let $x_0 \in \omega(c)$, $x_0 \in \text{Int}(U)$ and assume that for every $i \in \mathbb{N}$ the set U can be monotonically pulled-back along c_{n_i+1}, \dots, c_1 , where $U \ni c_{n_i+1} \rightarrow x_0$. Then U can be monotonically pulled back along some infinite backward orbit $x_0, x_{-1}, x_{-2}, \dots$, where $x_{-i} \in \omega(c)$ for every $i \in \mathbb{N}$.*

Proof. Note that the preimage of every interval consists of at most two intervals. So for every $k \in \mathbb{N}$ it is possible to find a maximal U^k (possibly not unique) such that $T^k(U^k) = U$ and U^k contains c_{n_i-k+1} for infinitely many $i \in \mathbb{N}$ ($k < n_i + 1$). Since we assumed that U can be monotonically pulled-back along c_{n_i+1}, \dots, c_1 for every $i \in \mathbb{N}$, U^k can be chosen such that $c \notin U^k$ for every $k \in \mathbb{N}$. Thus U, U^1, U^2, \dots is a monotone pull-back of U along an infinite backward orbit $x_0, x_{-1}, x_{-2}, \dots$, where $T^k(x_{-k}) = x_0$, $x_{-k} \in U^k$ and $x_{-k} \in \omega(c)$ for every $k \in \mathbb{N}$. □

The following lemma investigates the notion of persistent recurrence in more detail, and also gives a useful method to check whether c is persistently recurrent or not. The following Lemma was proven in [33], but since the setting slightly differs here, we give the complete proof. As in [33], for every $n \in \mathbb{N}$ we define $H_n(x)$ to be a maximal closed interval containing x on which T^n is monotone, and let $M_n(x) = T^n(H_n(x))$. Define $r_n(x) = \text{dist}(T^n(x), \partial M_n(x))$. Note that $H_n(x)$ is not necessarily unique, and that happens if and only if x is a critical point of T^n . In that case we choose any

Chapter 3. Unimodal inverse limit spaces

of the two maximal closed intervals containing x on which T^n is monotone. Specially, when $x = c_1$ (see the following lemma), the definition of $H_n(c_1)$ is ambiguous only for periodic c .

We also need the following definition:

Definition 3.23. *Dynamical system (X, f) is called minimal if $\text{Orb}(x)$ is dense in X for every $x \in X$.*

Lemma 3.24. *The critical point c is persistently recurrent if and only if $r_n(c_1) \rightarrow 0$.*

Proof. Note first that if c is periodic, then it is persistently recurrent. If c is periodic of period k , then $r_n(c_1) = 0$ for every $n > k$. So in the rest of the proof we assume that $\text{Orb}(c)$ is infinite.

Assume that $r_n(c_1) \not\rightarrow 0$, so there exists $\delta > 0$ and a sequence $(n_i)_{i \in \mathbb{N}}$ such that $r_{n_i}(c_1) > \delta$ for every $i \in \mathbb{N}$. Assume without loss of generality that (n_i) is strictly increasing and that there exists x such that $c_{n_i} \rightarrow x$. Then obviously $x \in \omega(c)$. Take $U \ni x$ such that $\text{diam}(U) < \delta$. Since $M_{n_i}(c_1) \supset U$, it follows that U can be monotonously pulled-back along $c_{n_i+1}, c_{n_i}, \dots, c_1$ for every $i \in \mathbb{N}$. From Lemma 3.22 it follows that c is reluctantly recurrent.

Now assume that $r_n(c_1) \rightarrow 0$ and c is not persistently recurrent. There is an infinite orbit x, x_{-1}, x_{-2}, \dots in $\omega(c)$, and $x \in \text{Int}(U)$ such that U can be monotonously pulled-back along it, let the U, U_1, U_2, \dots be the pull-back, and note that we can take U such that $\partial U \cap \omega(c) = \emptyset$, since $\omega(c)$ is (minimal) Cantor set by Proposition 3.1 in [33]. Fix $k \in \mathbb{N}$ and let n_k be the smallest number such that $c_{n_k+1} \in U_k$. Note that such n_k exists since $x_{-k} \in \omega(c)$. Note that $U_k \subset M_{n_k}(c_1)$ and thus $U \subset M_{n_k+k}(c_1)$ for every $k \in \mathbb{N}$. Since by assumption $r_n(c_1) \rightarrow 0$, it follows that the sequence $(c_{n_k+k+1})_k$ accumulates on ∂U . But we chose U such that the boundary points are not in $\omega(c)$, a contradiction. \square

Recall the main theorem of this chapter, Theorem 1.1:

It holds that $\mathcal{F} = \mathcal{E}$ if and only if c is persistently recurrent.

Chapter 3. Unimodal inverse limit spaces

Proof of Theorem 1.1. If c is reluctantly recurrent, there exist a folding point $x \in X$, an interval J such that $x_0 \in \text{Int}(J)$, and a monotone pull-back $(J_n)_{n \in \mathbb{N}_0}$ of J along x . Note that $\varprojlim \{J_n, T|_{J_n}\}$ is an arc in X and it contains x in its interior, thus x is not an endpoint.

In the other direction, assume that there is a folding point $x = (\dots, x_{-1}, x_0) \in X$ which is not an endpoint. Without loss of generality we can assume that x is contained in the interior of its basic arc. Otherwise, we use $\sigma^{-k}(x)$ for some $k \in \mathbb{N}$. Let A be a subset of the basic arc of x such that $\partial A \cap \text{Orb}(c) = \emptyset$ and such that $x \in \text{Int}(A)$. Let $A_k := \pi_k(A) \subseteq [c_2, c_1]$ for every $k \in \mathbb{N}_0$. Denote by $J = A_0$ and by $(J_n)_{n \in \mathbb{N}_0}$ the pull-back of J along x . Note that $A_n \subset J_n$ for every $n \in \mathbb{N}_0$. Since c is persistently recurrent, there exists the smallest $i \in \mathbb{N}$ such that $c \in \text{Int}(J_i)$. That means that $J_0 = A_0, J_1 = A_1, \dots, J_{i-1} = A_{i-1}$ and since $c \notin \text{Int}(A_n)$ and $A_n \subset [c_2, c_1]$ for every $n \in \mathbb{N}$, it holds that $c_1 \in \partial A_{i-1}$. But then c_i is an endpoint of $A_0 = A$, which is a contradiction. \square

In the rest of the section we make a finer subdivision of the set \mathcal{E} .

Definition 3.25. *An endpoint $x \in X$ is called flat if there exists $i \in \mathbb{N}_0$ such that $\sigma^{-i}(A(\overleftarrow{x}))$ is non-degenerate. If $\sigma^{-i}(A(\overleftarrow{x}))$ is degenerate for every $i \in \mathbb{N}_0$, but there exists a non-degenerate arc $A \subset X$ which contains x , then x is called spiral. An endpoint x which is not contained in any non-degenerate arc $A \subset X$ is called nasty, as in Remark 3.26.*

Remark 3.26. *Barge, Brucks and Diamond in [9] construct a dense G_δ set \mathcal{A} of parameters $s \in [\sqrt{2}, 2]$ for which the critical orbit is dense in the core and such that every open set in X'_s contains a copy of every unimodal inverse limit. Specifically, for $s \in \mathcal{A}$ there exist nasty points. The occurrence of nasty points for parameters $s \notin \mathcal{A}$ is poorly understood. Symbolic description of such points would be particularly useful. So far not a single nasty point (in tent map inverse limit) has been described symbolically!*

Remark 3.27. *In Theorem 1.1 we have actually proven that if c is persistently recurrent, then no non-degenerate basic arc can contain a folding point in its interior. So the possible folding points are either degenerate basic arcs*

Chapter 3. Unimodal inverse limit spaces

or flat endpoints. In the rest of this section we show that both types can occur and show how that relates to the condition $Q(k) \rightarrow \infty$.

Remark 3.28. Note that $Q(k) \rightarrow \infty$ implies that c is persistently recurrent (but not vice versa, see [30], Proposition 3.1). However, $Q(k) \rightarrow \infty$ is equivalent to $|D_n| \rightarrow 0$, see [27], Exercise 6.1.8.

Proposition 3.29. If $Q(k) \rightarrow \infty$, then all folding points are degenerate basic arcs (so either spiral or nasty endpoints).

Proof. Since $Q(k) \rightarrow \infty$, also $|D_n| \rightarrow 0$ as $n \rightarrow \infty$ and c is persistently recurrent, so every folding point is an endpoint. If x is an endpoint, then $\tau_L(\overleftarrow{x}) = \infty$ or $\tau_R(\overleftarrow{x}) = \infty$. Assume without loss of generality that $\tau_L(\overleftarrow{x}) = \infty$, so $\mathcal{L}(\overleftarrow{x})$ is an infinite set. Since $A(\overleftarrow{x}) \subseteq \bigcap_{l \in \mathcal{L}(\overleftarrow{x})} D_l$ and $|D_n| \rightarrow 0$, it follows that $A(\overleftarrow{x})$ is degenerate. \square

Question 3.30. Is it true that if $Q(k) \rightarrow \infty$ and T is not infinitely renormalizable, then all the folding points in X' are spiral?

Remark 3.31. Nasty points (points not contained in an arc) are realized as nested intersections of non-arc subcontinua, see [40]. So if the structure of subcontinua of X is simple enough, nasty points cannot exist. In [28, 31] the authors give conditions which imply that all subcontinua are Elsa continua. Specifically, it follows that if $Q(k) \rightarrow \infty$, together with one more technical condition, then every folding point of X is a spiral endpoint, i.e., degenerate basic arc contained in an arc of X . So if the technical condition can be removed, the answer to the question above is yes.

Proposition 3.32. If $Q(k) \not\rightarrow \infty$, then there exists a folding point which is contained in a non-degenerate basic arc.

Proof. If $Q(k) \not\rightarrow \infty$, then $|D_n| \not\rightarrow 0$ so there exists a sequence $(n_i)_{i \in \mathbb{N}}$ and $\delta > 0$ such that $|D_{n_i}| > \delta$ for every $i \in \mathbb{N}$. For every $n \in \mathbb{N}$ there exists a basic arc A_n with $\pi_0(A_n) = D_n$, e.g. take $A_n = A(\overleftarrow{x})$ for $\overleftarrow{x} = \dots 111\nu_1 \dots \nu_{n-1}$. The sequence of basic arcs A_{n_i} accumulate on some basic arc A with $|\pi_0(A)| \geq \delta$. Note that such a basic arc A must contain a folding point (which can be

an endpoint of A or in the interior of A). For example, since $n_i \rightarrow \infty$, every point in A which is an accumulation point of the endpoints y_{n_i} of A_{n_i} with the property that $\pi_0(y_{n_i}) = c_{n_i}$ has the property that its every projection is contained in $\omega(c)$. \square

Corollary 3.33. *If $Q(k) \not\rightarrow \infty$ and c is persistently recurrent, then there exists a flat endpoint.*

3.5 Arc-components

We use the fact that spiral points are endpoints to obtain a symbolic characterization of arc-components. We specially discuss the arc-component \mathfrak{R} needed in Chapter 4. Part of this section is contained in paper [7].

Recall that the arc-component of $x \in X$ is the union of all arcs in X which contain x and we denote it by \mathfrak{A}_x . Recall also that a point $x \in X$ is called a *spiral point* if $\sigma^{-i}(A(\overleftarrow{x}))$ is degenerate for every $i \in \mathbb{N}_0$, but x is contained in an arc of X . Specifically, there exists a ray $R \subset X$ (a spiral) such that x is an endpoint of R and $[x, y] \subset R$ contains infinitely many basic arcs for every $x \neq y \in R$. See Figure 3.1.

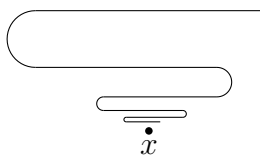

Figure 3.1: Point $x \in X$ is a spiral point.

The following corollary follows directly from Remark 3.17 since a spiral point is an endpoint and thus cannot be contained in the interior of an arc.

Corollary 3.34. *Non-degenerate arc-components in X are:*

- *lines (i.e., continuous images of \mathbb{R}) with no spiral points,*
- *rays (continuous images of \mathbb{R}^+), where only the endpoint can be a spiral point,*

- arcs, where only endpoints can be spiral points.

Remark 3.35. Let $x \neq y \in X$. By Lemma 3.4, $A(\overleftarrow{x})$ and $A(\overleftarrow{y})$ are connected by finitely many basic arcs if and only if there exists $k \in \mathbb{N}$ such that $\dots x_{-(k+1)}x_{-k} = \dots y_{-(k+1)}y_{-k}$. We say that x and y have the same tail. Thus every arc-component is determined by its tail with the exception of (one or two) spiral points with different tails. This generalizes the symbolic representation of arc-components for finite critical orbit c given in [29] on arbitrary tent inverse limit space X .

We emphasize one arc-component which will play a crucial role in the next Chapter.

Remark 3.36. For a fixed s , let \mathfrak{R} be an arc-component of the fixed point $\rho := (\dots, r, r, r)$, where $r = \frac{s}{s+1}$ is the fixed point of T_s in $[c_2, c_1]$. Note that $I(\rho) = \dots 11.11\dots$, so \mathfrak{R} is determined by the left-infinite tail $\dots 11$. That is, for every $x \in \mathfrak{R}$ with left-infinite tail $\overleftarrow{x} = \dots x_{-2}x_{-1}$ there exists $n \in \mathbb{N}$ such that $x_{-k} = 1$ for every $k \geq n$. Moreover, if $x_0x_1\dots$ is an admissible forward itinerary of a point in $[c_2, c_1]$, then $1x_0x_1\dots$ is also an itinerary of a point in $[c_2, c_1]$. Otherwise $1x_0x_1\dots \succ \nu_1\nu_2\dots$, which implies $x_0x_1\dots \prec \nu_2\dots$, and that is a contradiction. Thus, for every $y \in [c_2, c_1]$ with $i(y) = y_0y_1\dots$ the sequence $\dots 11y_0\dots y_{k-1}.y_k\dots$ is admissible. This implies that $\pi_k(\mathfrak{R}) = [c_2, c_1]$ for every $k \in \mathbb{N}_0$. Specially, $\mathfrak{R} \subset X'$ and it is dense in X' in both directions.

Chapter 4

The Core Ingram Conjecture

In this chapter we prove the Core Ingram conjecture for non-recurrent critical orbits. That is, we prove that if $1 \leq s < \tilde{s} \leq 2$ and critical points of T_s and $T_{\tilde{s}}$ are non-recurrent, then the inverse limit spaces $\varprojlim([c_2, c_1], T_s)$ and $\varprojlim([\tilde{c}_2, \tilde{c}_1], T_{\tilde{s}})$ are not homeomorphic. Recall from Section 2.3.3 that if T_s has a non-recurrent critical orbit, then $\varprojlim([c_2, c_1], T_s)$ has no endpoints and if the critical orbit is recurrent, $\varprojlim([c_2, c_1], T_s)$ has endpoints (finitely many if the critical point is periodic and infinitely many if the critical orbit is infinite). Thus, the recurrent and non-recurrent case are topologically different.

The question of topological classification of unimodal inverse limit spaces (known as the *Ingram conjecture*) has been open for a long time and has generated a vast number of papers. It was finally finished by Barge, Bruin and Štimac in [10] by exploiting the special properties of the ray \mathfrak{C} . The natural approach when \mathfrak{C} is absent is to pick some other dense arc-component, preferably preserved under homeomorphisms, and make a detailed study of its topological structure with respect to the slope s . This was the approach in [37] where the authors chose the arc-component \mathfrak{R} (which exists in every X'_s) and showed that it is preserved under homeomorphisms provided that the bonding maps are *Fibonacci-like*. Here we show that the conclusion follows also in the case when the critical points of the bonding maps are non-recurrent. We will restrict to the infinite non-recurrent critical orbit case. In the finite case the Core Ingram conjecture was obtained already in [83] since there the

Chapter 4. The Core Ingram Conjecture

author does not work on the arc-component \mathfrak{C} . The results of this chapter were previously published in [3].

Remark 4.1. *We will, without loss of generality, work with indecomposable cores, i.e., for $\sqrt{2} < s \leq 2$. An arbitrary arc-component \mathfrak{U}_x will often be denoted just by \mathfrak{U} .*

Definition 4.2. *Let $s > 1$ and $\mathfrak{U} \subset X_s$ and arbitrary arc-component. The arc-length distance of two points $u, v \in \mathfrak{U}$ is defined as*

$$d(u, v) := s^k |u_{-k} - v_{-k}|,$$

where $k \in \mathbb{N}_0$ is such that $\pi_k: [u, v] \rightarrow [c_2, c_1]$ is injective. Note that this definition does not depend on the choice of $k \in \mathbb{N}_0$.

We introduce some more dynamical properties of tent maps which will be needed throughout this chapter.

Definition 4.3. *We say that $x \in [0, 1]$ is a turning point of T_s^j , if there exists $m < j \in \mathbb{N}$ such that $T_s^m(x) = c$. Two turning points $x, y \in [0, 1]$ of T_s^j are adjacent if $T_s^j|_{[x, y]}$ is monotone.*

For $b \in [0, 1]$ let $\hat{b} := 1 - b$ denote the symmetric point around c .

Lemma 4.4. *Let $a < b < d < e \in [0, 1]$, where b and d are turning points of T_s^j for some $j \in \mathbb{N}$, and T_s^j has no other turning point in (a, e) . Then $T_s^j(a) \in [T_s^j(b), T_s^j(d)]$ or $T_s^j(e) \in [T_s^j(b), T_s^j(d)]$.*

Proof. Assume that $T_s^j(a) < T_s^j(d) < T_s^j(b) < T_s^j(e)$, see Figure 4.1.

Case I: Let $m < n < j$ such that $T_s^m(b) = c = T_s^n(d)$. We consider the image of $[a, e]$ under T_s^m .

- (a) Let $|T_s^m(a) - c| \geq |T_s^m(e) - c|$. This means that $\widehat{T_s^m(e)} \in [c, T_s^m(a)]$. Consequently, there is a point $x \in (a, b)$ such that $T_s^m(x) = \widehat{T_s^m(d)}$, but then $T_s^n(x) = T_s^n(d) = c$, contradicting that (a, b) contains no turning point of T_s^j .
- (b) Let $|T_s^m(a) - c| < |T_s^m(e) - c|$. This means that $\widehat{T_s^m(a)} \in [c, T_s^m(e)]$. Consequently, there exists a point $y \in (b, e)$ such that $T_s^m(y) = \widehat{T_s^m(a)}$. It

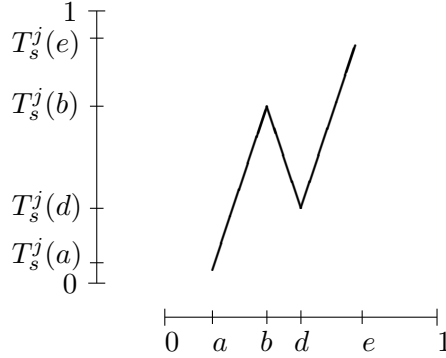

Figure 4.1: Example of a pattern that is not allowed by Lemma 4.4.

follows that $T_s^j(y) = T_s^j(a) < T_s^j(d)$ which contradicts that d is the minimum of T_s^j in (b, e) .

Case II: Let $m < n < j$ such that $T_s^m(d) = c = T_s^n(b)$. Again we consider $T_s^m|_{[a,e]}$.

(a) Let $|T_s^m(a) - c| \geq |T_s^m(e) - c|$. This means that $\widehat{T_s^m(e)} \in [c, T_s^m(a)]$. Therefore there exists a point $y \in (a, d)$ such that $T_s^j(y) > T_s^j(b)$, which contradicts that b is the maximum of T_s^j in (a, d) .

(b) Let $|T_s^m(a) - c| < |T_s^m(e) - c|$. This means that $\widehat{T_s^m(a)} \in [c, T_s^m(e)]$. Thus there exists $x \in (d, e)$ such that $T_s^n(x) = T_s^n(b) = c$, contradicting that (d, e) contains no turning point of T_s^j . The case when $T_s^j(a) > T_s^j(d) > T_s^j(b) > T_s^j(e)$ follows analogously. \square

Remark 4.5. *The previous Lemma shows that there are no zigzags in any iterate of T_s . See the definition of a zigzag in Section 5.5. It also shows that given any arc $A \subset X_s$ and any natural chain \mathcal{C}_k of X_s (as constructed in Remark 2.21), A either goes “straight through” a link $\ell \subset \mathcal{C}_k$ or it “turns” in ℓ . This notions are studied in the following section.*

4.1 Patterns and symmetry

Recall that the approach to proving the Core Ingram conjecture is to topologically differentiate \mathfrak{R} within the set of dense arc-components of X . We

Chapter 4. The Core Ingram Conjecture

will study the patterns of \mathfrak{R} through natural chains \mathcal{C}_k , focusing on the link-symmetric subarcs. In this section we introduce the concepts of pattern and symmetry.

Definition 4.6. A point $u \in X_s$ is called a k -point (with respect to the chain \mathcal{C}_k) if there exists $n \geq 1$ such that $\pi_{k+n}(u) = c$. Note that if c is not periodic, such n is unique and we call it the k -level of u and denote it by $L_k(u)$.

Definition 4.7. Let $A \subset X'_s$ be an arc and let $u_0, \dots, u_N \in A$ be a complete list of k -points such that $u_0 \prec u_1 \prec \dots \prec u_N$, where the order \prec is inherited from the standard order on $[0, 1]$ via a parametrization $\varphi : [0, 1] \rightarrow A$. Then the list of levels $L_k(u_0), L_k(u_1), \dots, L_k(u_N)$ is called k -pattern of A .

Remark 4.8. From the Definition 4.7 it follows that A is the concatenation of arcs $[u_{j-1}, u_j]$ with pairwise disjoint interiors and π_k maps $[u_{j-1}, u_j]$ bijectively onto $[c_{L_k(u_{j-1})}, c_{L_k(u_j)}]$. Equivalently, if $i \in \mathbb{N}_0$ is such that $\pi_{k+i} : A \rightarrow \pi_{k+i}(A)$ is injective, then the graph $T^i|_{\pi_{k+i}(A)}$ has the same k -pattern as A . That is, T^i has turning points $\pi_{k+i}(u_0) < \dots < \pi_{k+i}(u_N)$ in $\pi_{k+i}(A)$ and $T^i(\pi_{k+i}(u_j)) = c_{L_k(u_j)}$ for $0 \leq j \leq N$. We will call this list k -pattern of $T^i|_{\pi_{k+i}(A)}$ as well.

Example 4.9. The arc A as in Figure 4.2 has a k -pattern 312 or 213, depending on the choice of orientation.

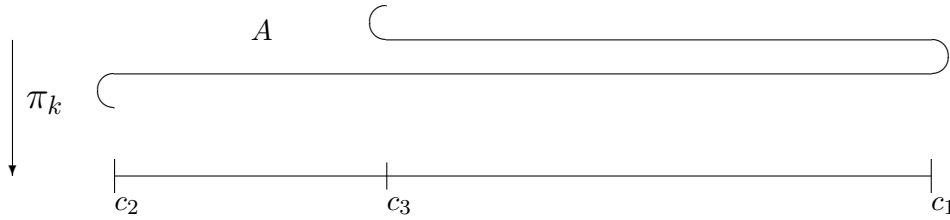

Figure 4.2: Arc A with k -pattern 312

Definition 4.10. We say that an arc $A := [e, e'] \subset X'_s$ is k -symmetric if $\pi_k(e) = \pi_k(e')$ and the k -pattern of the open arc (e, e') is a palindrome.

Remark 4.11. Definition 4.10 implies that the k -pattern of (e, e') , where A is a k -symmetric arc, is of odd length and the letter in the middle is the largest. This can be easily seen by considering the smallest $j > k$ such that $\pi_j : A \rightarrow [c_2, c_1]$ is injective.

Chapter 4. The Core Ingram Conjecture

Lemma 4.12. *Let P be a k -pattern that appears somewhere in X'_s , i.e., there is an arc $A \subset X'_s$ with k -pattern P . If arc-component \mathfrak{U} contains no arc with k -pattern P , then \mathfrak{U} is not dense in X'_s .*

Proof. For every pattern P that appears in X'_s there exist $n \in \mathbb{N}$ and $J \subset [c_2, c_1]$ such that the graph of $T_s^n|_J$ has pattern P . This means that if there is a subarc $A \subset \mathfrak{U}$ such that π_{k+n} maps A injectively onto J , then A has k -pattern P . If \mathfrak{U} is dense in X'_s , then $\pi_{k+n}(\mathfrak{U}) = [c_2, c_1]$ for every $n \in \mathbb{N}_0$. By Lemma 4.4 there exists an arc $B \subset \mathfrak{U}$ such that $\pi_{k+n}(B)$ maps injectively onto $[c_2, c_1]$. Thus there indeed exists $A \subset B \subset \mathfrak{U}$ such that π_{k+n} maps A injectively onto J . This finishes the proof. \square

Definition 4.13. *Take an arc-component \mathfrak{U} and a natural chain \mathcal{C}_k of X'_s for some $k \in \mathbb{N}$. For a point $u \in \mathfrak{U}$ such that $u \in \ell \in \mathcal{C}_k$ we denote the arc-component of $\ell \cap \mathfrak{U}$ containing u by A_ℓ^u , or simply A^u if the link $\ell \in \mathcal{C}_k$ is clear from the context.*

Definition 4.14. *Given a chain \mathcal{C} and an arc $A \subset X'_s$, the link-pattern $LP(A)$ is the list of links $\ell \in \mathcal{C}$ that A goes through consecutively.*

Remark 4.15. *Definition 4.14 is somewhat ambiguous, because we do not indicate which linear order we take, and more importantly, whether we include the first/last link that A intersects if already the list without the first/last link covers A . We allow each of these lists to serve as a link-pattern.*

Definition 4.16. *Arc A is called k -link-symmetric (with respect to the chain \mathcal{C}_k) if A has a link-pattern which is a palindrome. This link-pattern then automatically has odd length, and there is a unique link in the middle, the midlink ℓ , which contains a unique arc-component $A^m \subset A \cap \ell$ corresponding to the middle letter of the palindrome. We call the point m in A^m with the largest k -level the midpoint of A .*

Remark 4.17. *The definition of the midpoint m above is just for completeness; since we can not topologically distinguish points in the same arc component A^m , any point $u \in A^m$ would serve equally well. If A is contained in a single link $\ell \in \mathcal{C}_k$, then it is k -link symmetric by default, but $\ell \cap A$ does*

not need to contain a k -point. In that case, any point in $\ell \cap A$ can serve as midpoint of A .

Remark 4.18. Every k -symmetric arc is also k -link-symmetric but the converse does not hold. This is one of the main obstacles in the proof of the Core Ingram Conjecture.

Definition 4.19. We define the reflection of $v \in \mathfrak{U}$ around $u \in \mathfrak{U}$ as a point $R_u(v) \in \mathfrak{U}$ such that $[v, R_u(v)]$ is k -link symmetric with midpoint u . If possible, we choose $R_u(v)$ so that $[v, R_u(v)]$ is a k -symmetric arc.

Definition 4.20. We define the reflection around $a \in \mathbb{R}$ by $\bar{R}_a(x) := 2a - x$ for all $x \in \mathbb{R}$.

4.2 The structure of \mathfrak{R} – arcs A_i

Recall that \mathfrak{R} is the arc-component in X'_s containing the point $\rho = (\dots, r, r, r)$.

Definition 4.21. Let \mathcal{C}_k be a natural chain of $\varprojlim ([c_2, c_1], T_s)$. For every $i \in \mathbb{N}$ we define $A_i \subset \mathfrak{R}$ to be the arc-component of $\pi_{k+i}^{-1}([c_2, \hat{c}_2])$ which contains ρ and let $m_i := \pi_{k+i}^{-1}(c) \in A_i$.

Lemma 4.22. The arc $A_i \subset \mathfrak{R}$ is k -symmetric with midpoint m_i for every $i \in \mathbb{N}$.

Proof. For every $i \in \mathbb{N}$ we obtain that $\pi_{k+i}(A_i) = [c_2, \hat{c}_2]$ injectively on $[c_2, c_1]$ which is symmetric around c and so A_i is k -symmetric. \square

Define

$$\xi := \min\{i \geq 3 : c_i \leq c\}.$$

Remark 2.31 implies ξ always exists and $\xi - 3$ has to be an even number or 0, otherwise the tent map T_s is renormalizable (which we excluded by taking the slope $s > \sqrt{2}$).

Now we explain some basic facts that we often use in the following lemmas.

Chapter 4. The Core Ingram Conjecture

Assume that T_s is such that $\xi > 3$. Because ξ is the smallest natural number so that $c_2 < c_\xi \leq c$ it follows that $c_i > c$ for $i \in \{3, \dots, \xi - 1\}$. Furthermore, since $s > 1$ and we restrict to non-renormalizable maps, it follows that $c < c_{\xi-2} < \dots < c_5 < c_3 < r < c_4 < c_6 < \dots < c_{\xi-1} < c_1$. Because $T_s|_{[c, c_1]}$ reverses orientation, we obtain $r < \hat{c}_2 < c_4$.

To see that $\pi_{k+i} \circ \sigma = T_s \circ \pi_{k+i}$, take a point $u = (\dots, u_{-2}, u_{-1}, u_0) \in \varprojlim([0, 1], T_s)$. Then $\pi_{k+i}(\sigma((\dots, u_{-2}, u_{-1}, u_0))) = \pi_{k+i}((\dots, u_{-1}, u_0, T_s(u_0))) = u_{-(k+i)+1} = T_s(u_{-(k+i)}) = T_s(\pi_{k+i}(u))$.

Lemma 4.23. $A_i \subset A_{i+2}$ for all $i \in \mathbb{N}$.

Proof. Note that $\pi_{k+i}(A_i) = \pi_{k+i+2}(A_{i+2}) = [c_2, \hat{c}_2]$. We distinguish two cases:

Case I: Let $c_3 < c$. Then $c \in \pi_{k+i+1}(A_{i+2})$ and there exists an arc $B \subset A_{i+2}$ such that $\rho \in B$ and $\pi_{k+i}(B) = [c_2, c_1]$ injectively, see Figure 4.3. Since $A_i \subset B$ it follows that $A_i \subset A_{i+2}$.

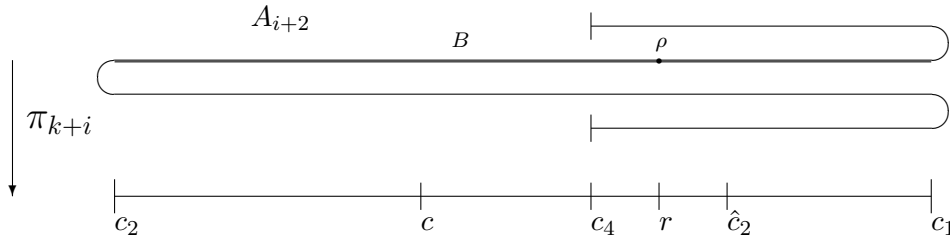

Figure 4.3: The arc A_{i+2} as in Case I.

Case II: Let $c_3 \geq c$. Because $c_3 = T_s(\hat{c}_2) < r < \hat{c}_2 < c_4$, T_s maps $\pi_{k+i}(A_{i+2})$ in a 2-to-1 fashion onto the interval $[c_2, c_4]$, see Figure 4.4. We find an arc $B \subset A_{i+2}$ such that $\rho \in B$ and $\pi_{k+i}(B) = [c_2, c_4]$ injectively. Because $c_4 > \hat{c}_2$ also $A_i \subset A_{i+2}$. \square

In the following lemma let $A_{i,j} \subset A_i \subset \mathfrak{R}$ denote the longest arc (in arc-length) such that $\rho \in A_{i,j}$ and $\pi_{k+j} : A_{i,j} \rightarrow [c_2, c_1]$ is injective for some $j \leq i$, see Figure 4.5. Note that $A_{i,i} = A_i$.

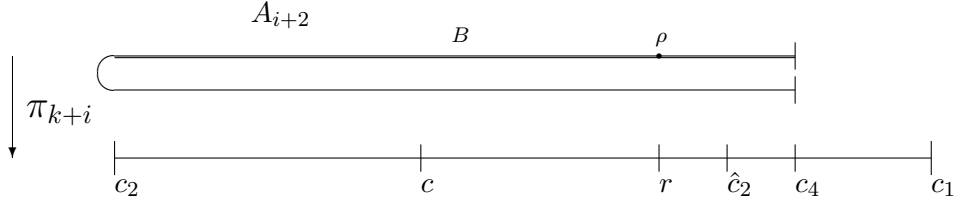

Figure 4.4: The arc A_{i+2} as in Case II.

Lemma 4.24. $A_i \subset A_{i+\xi}$ and $A_i \not\subset A_{i+l}$ for every $i \in \mathbb{N}$ and every odd $l < \xi$.

Proof. We distinguish two cases:

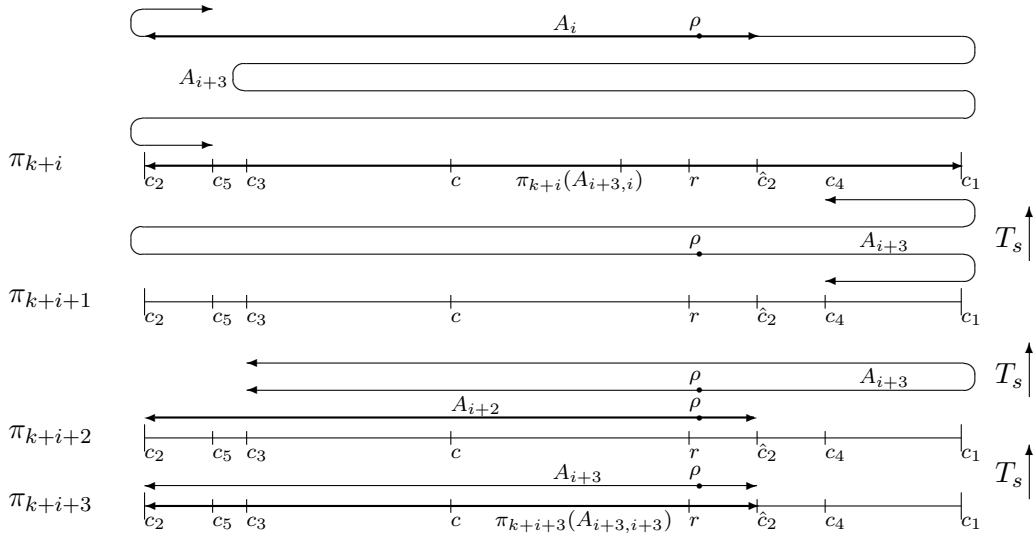

Figure 4.5: Arcs $A_i, A_{i+1}, A_{i+2}, A_{i+3}$ in mentioned projections as in Case I.

Case I: First assume that $\xi = 3$. Since $T_s(c_2) = c_3 > c_2$ it follows that $\pi_{k+i}(A_i) \not\subset \pi_{k+i}(A_{i+1})$ and thus $A_i \not\subset A_{i+1}$. However, $[c, c_1] \subset \pi_{k+i+2}(A_{i+3,i+2}) = T_s([c_2, \hat{c}_2])$. This means that $\pi_{k+i+1}(A_{i+3,i+1}) = [c_2, c_1]$ and hence $\pi_{k+i}(A_{i+3,i}) = [c_2, c_1]$, see Figure 4.5. we conclude that $A_i \subset A_{i+3}$. This finishes the proof for $\xi = 3$.

Case II: Let $\xi \geq 5$. Note that $c_\xi < c < c_i$ for every $i \in \{3, \dots, \xi - 1\}$.

Chapter 4. The Core Ingram Conjecture

Thus we observe that $[c_2, \hat{c}_2] \not\subset \pi_{k+i+\xi-l}(A_{i+\xi, i+\xi-l}) = [c_{2+l}, c_1]$ for every odd $l \in \{1, \dots, \xi - 4\}$. It follows that $A_i \not\subset A_{i+l}$ for every odd $l \in \{1, \dots, \xi - 4\}$. Because $T_s^{\xi-2}(c_2) = c_\xi$ it follows that $[c, c_1] \subset \pi_{k+i+2}(A_{i+\xi, i+2}) = [c_\xi, c_1]$ and $k+i+2$ is the smallest such index. However, because $c_2 < c_\xi$ and $\pi_{k+i+2}(A_{i+2}) = [c_2, \hat{c}_2] \not\subset \pi_{k+i+2}(A_{i+\xi, i+2})$ it also holds that $\pi_{k+i}(A_i) \not\subset \pi_{k+i}(A_{i+\xi-2, i})$, so $A_i \not\subset A_{i+\xi-2}$. As above we observe that $\pi_{k+i}(A_{i+\xi, i}) = [c_2, c_1]$ and thus $A_i \subset A_{i+\xi}$. \square

Recall that m_i denotes the midpoint of the arc A_i .

Lemma 4.25. *It holds that $m_{i+2} \in \partial A_i$ and $m_{i+1} \notin A_i$. Furthermore, if $\xi = 3$, then $m_i \in A_{i+1}$ and if $\xi > 3$, then $m_i \notin A_{i+1}$.*

Proof. Since $\pi_{k+i}(m_i) = c$, also $\pi_{k+i}(m_{i+2}) = c_2$. Because $A_i \subset A_{i+2}$ it follows that $m_{i+2} \in \partial A_i$.

To prove the second statement, observe that $\pi_{k+i}(m_{i+1}) = c_1 \notin [c_2, \hat{c}_2]$ for $s < 2$.

For the third statement first assume that $\xi = 3$; it follows that $c \in [c_3, c_1]$ and so $m_i \in A_{i+1}$. If $\xi > 3$ then $c_3 > c$ and thus $c \notin \pi_{k+i}(A_{i+1})$, so it follows that $m_i \notin A_{i+1}$. \square

Lemma 4.26. *It holds that $\rho \in [m_i, m_{i+1}]$ and $\rho \notin [m_i, m_{i+2}]$ for all $i \in \mathbb{N}$.*

Proof. By definition $\pi_{k+i}(A_i) = [c_2, \hat{c}_2]$ and $\pi_{k+i}(m_i) = c$, so $\pi_{k+i}(m_{i+1}) = T_s(\pi_{k+i}(m_i)) = c_1$. Since $r \in [\pi_{k+i}(m_i), \pi_{k+i}(m_{i+1})]$ it follows that $\rho \in [m_i, m_{i+1}]$.

The second statement of the lemma follows directly from Lemma 4.25. \square

Lemma 4.25 states that $m_{i+2} \in \partial A_i$. We denote the other boundary point of A_i by \hat{m}_{i+2} .

Note that all properties of (k -link symmetric) arcs $\{A_i\}_{i \in \mathbb{N}}$ proved in this section are topological, meaning they are preserved under a homeomorphism.

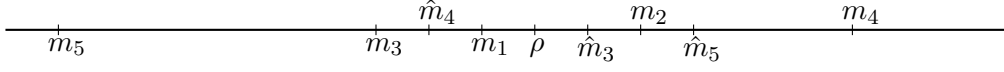

Figure 4.6: The structure of the arc-component \mathfrak{R} ; $A_i = [m_{i+2}, \hat{m}_{i+2}]$ has midpoint m_i .

4.3 ε -symmetry

Definition 4.27. Let $J := [a, b] \subset [c_2, c_1]$ be an interval. The map $f: J \rightarrow \mathbb{R}$ is called ε -symmetric if there is a continuous bijection $x \mapsto \hat{x}$ swapping a and b , such that $|f(x) - f(\hat{x})| < \varepsilon$ for all $x \in J$. Since $i: J \rightarrow J$ has a unique fixed point m , we say that f is ε -symmetric with center m (or just ε -symmetric around m).

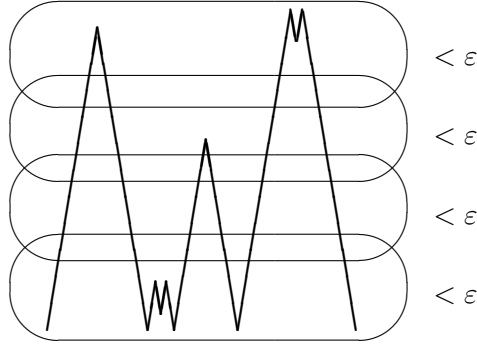

Figure 4.7: A graph of an ε -symmetric map.

Remark 4.28. Let $A \subset \mathfrak{R}$ be a k -link symmetric arc with midpoint m_A , where $\text{mesh}(\mathcal{C}_k) < \varepsilon$. If i is such that $\pi_{k+i}|_A: A \rightarrow \pi_{k+i}(A)$ is injective in $[c_2, c_1]$, then $T^i|_{\pi_{k+i}(A)}$ is ε -symmetric around $\pi_{k+i}(m_A)$, see Figure 4.7.

Next we restate Proposition 3.6. from [10] although the definition of ε -symmetry is slightly generalized here. However, all arguments in the proof of Proposition 3.6. from [10] with the new definition of ε -symmetry remain the same.

Proposition 4.29. For every $\delta > 0$ there exists $\varepsilon > 0$ such that for every $n \geq 0$ and every interval $H = [a, b] \ni m$ such that $|m - c|, |c - a|, |c - b| > \delta$, $T^n|_H$ is not ε -symmetric around m .

4.4 Completeness of the sequence $\{A_i\}_{i \in \mathbb{N}}$

In this section we prove that the sequence of symmetric arcs $\{A_i\}$ in \mathfrak{R} is complete in a sense of the following definition. That result provides a topologically invariant structure which shows to be unique to \mathfrak{R} , at least among the arc-components of X'_s for *non-recurrent* critical orbit c . So far there is no reason to believe that this does not hold for more general spaces X'_s , but the proof is still missing.

Definition 4.30. *Let $k \in \mathbb{N}$, $u \in \mathfrak{U}$, and let $\{G_i\}_{i \in \mathbb{N}} \subset \mathfrak{U}$ be a sequence of k -link symmetric arcs with midpoints m_i respectively, and $u \in G_i$, for all $i \in \mathbb{N}$. The sequence $\{G_i\}_{i \in \mathbb{N}}$ is called a complete sequence of k -link symmetric arcs with respect to u if every k -link symmetric arc $G \subset \mathfrak{U}$ such that $u \in G$ (not contained in a single link of a chain \mathcal{C}_k) has midpoint in $\{m_i\}_{i \in \mathbb{N}}$.*

Proposition 4.31. *There exists $\varepsilon > 0$ such that $\{A_i\}_{i \in \mathbb{N}}$ is a complete sequence of k -link symmetric arcs with respect to ρ for every $k \in \mathbb{N}$ with $\text{mesh}(\mathcal{C}_k) < \varepsilon$.*

Proof. Fix $\delta := \frac{1}{2} \min\{|c - r|, |c - x| : x \in T^{-2}(c)\}$, take $\varepsilon > 0$ as in Proposition 4.29 and a chain \mathcal{C}_k such that $\text{mesh}(\mathcal{C}_k) < \varepsilon$. Assume that there exists a k -link symmetric arc $B \ni \rho$ in \mathfrak{R} which is not contained in a single link of \mathcal{C}_k and its midpoint $m \neq m_i$ for every $i \in \mathbb{N}$. Without loss of generality we can assume that

$$m \text{ is the closest to } \rho \text{ (arc-length) among all midpoints of such arcs.} \quad (4.1)$$

Since m is a k -point and there are no k -points in (m_1, m_2) , we obtain that $m \notin (m_1, m_2)$. Thus by Lemma 4.26 there exists $i \in \mathbb{N}$ such that $m \in (m_{i+2}, m_i)$.

Case I: Assume that $R_m(m_i) \in [m_{i+2}, m_i] \cup A^{m_{i+2}}$ (recall Definitions 4.13 and 4.19).

Let $A \subset B \cap [m_{i+2}, \hat{m}_{i+2}]$ be the maximal k -link symmetric arc with midpoint

Chapter 4. The Core Ingram Conjecture

m . Let a, b be the boundary points of A such that $m_{i+2} \preceq b \prec m_i \prec a \preceq \hat{m}_{i+2}$ (recall that \prec denotes linear order on \mathfrak{R}).

Denote by $a' := R_{m_i}(a)$, $b' := R_{m_i}(b)$, $m' = R_{m_i}(m)$ and $\rho' := R_{m_i}(\rho)$, so that the arcs $[a, a']$, $[b, b']$ and $[\rho, \rho']$ are k -symmetric arcs with midpoint m_i . Define an arc $A' := [a', b']$, see Figure 4.8.

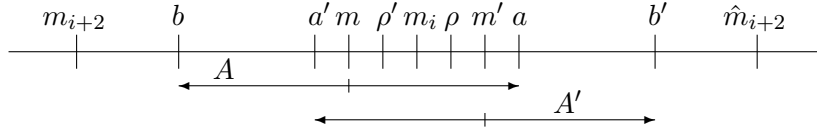

Figure 4.8: Case I of the proof.

Since A is k -link symmetric and $A \subset [m_{i+2}, \hat{m}_{i+2}]$, A' is k -link symmetric with midpoint m' .

Note that either $b = m_{i+2}$ or $b \prec m_{i+2}$.

If $b = m_{i+2}$ it holds by the assumption of Case I that $[m_{i+2}, m_i] \subset A$ and thus $\rho' \in A$. Therefore $\rho \in A'$.

If $b \prec m_{i+2}$, then by assumption of Case I it follows that $B = A$ and thus $\rho \in A$. Because $m \prec m_i \prec \rho$, it follows that $\rho' \in A$ and thus again $\rho \in A'$.

By (4.1) there exists $j < i$ such that $m' = m_j$.

Now we study $\pi_{k+i}(A)$, see Figure 4.9. Since $m \in (m_{i+2}, m_i)$ it follows that $\pi_{k+i}(m) \in (c_2, c)$.

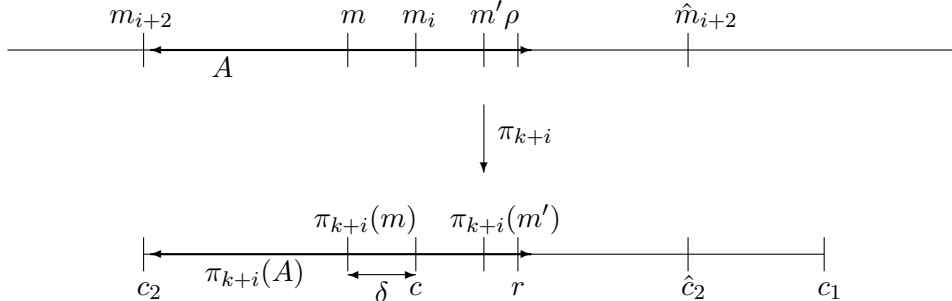

Figure 4.9: Arc A in projection π_{k+i} as in Case I of the proof.

If $|\pi_{k+i}(m) - c| > \delta$, we use Proposition 4.29 to conclude that A is not k -link symmetric, a contradiction. Assume that $|\pi_{k+i}(m) - c| \leq \delta$. Since $m' = m_j$ for some $j < i$ it follows that $m' \notin (m_{i-2}, m_i)$. Thus $|\pi_{k+i}(m) - c| = |\pi_{k+i}(m') - c| = |\pi_{k+i}(m_j) - c| \geq |\pi_{k+i}(m_{i-2}) - c| > \delta$, a contradiction. The last inequality follows from the fact that $\pi_{k+i}(m_{i-2}) \in T^{-2}(c)$ and the definition of δ .

Case II: Assume that $R_m(m_i) \notin [m_{i+2}, m_i] \cup A^{m_{i+2}}$.

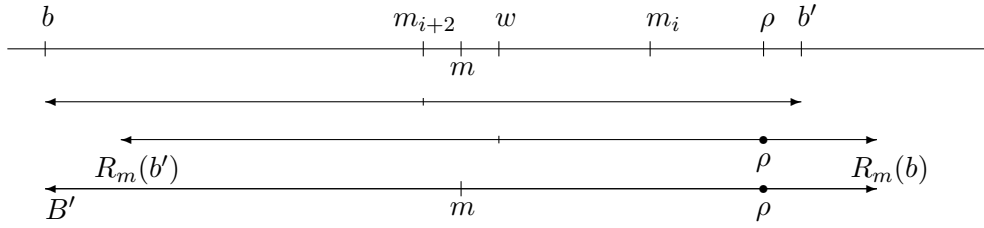

Figure 4.10: Reflections as in Case II of the proof.

Let b be the endpoint of $B \cap [m_{i+4}, m_{i+2}]$ that is the furthest away from ρ . Take $w := R_m(m_{i+2})$ (see Definition 4.19) and note that $w \in (m, m_i)$ by the assumption for this case. Denote by $b' := R_{m_{i+2}}(b)$ so that the arc $[b, b'] \subset [m_{i+4}, \hat{m}_{i+4}]$ is k -symmetric with midpoint m_{i+2} . We reflect the arc $[b, b']$ over m and obtain an arc $[R_m(b'), R_m(b)]$ (see Figure 4.10) which is k -link symmetric with midpoint w . Denote by B' the maximal k -link symmetric arc around m such that $B' \subset B \cap [m_{i+4}, \hat{m}_{i+4}]$. Since $[m_{i+4}, \hat{m}_{i+4}]$ is k -link symmetric around m_{i+2} and $\rho \in [m_{i+2}, \hat{m}_{i+4}]$, counting the links through which the arcs $[m_{i+2}, \rho] \supset [m, \rho]$ pass consecutively, we conclude that $\rho \in B'$, see Figure 4.10. So $R_m(\rho)$ is well-defined and $R_m(\rho) \in [b, m]$. We conclude that $\rho \in [R_m(b'), R_m(b)]$ which contradicts the minimality of m , because we found a k -link symmetric arc $[R_m(b'), R_m(b)]$ with midpoint w such that $[R_m(b'), R_m(b)] \ni \rho$, $[w, \rho] \subset [m, \rho]$ and $w \in (m_{i+2}, m_i)$. \square

4.5 ε -symmetry and ε -closeness in the infinite non-recurrent case

The results in this section rely on the non-recurrence of the critical point.

Chapter 4. The Core Ingram Conjecture

Proposition 4.32. *Assume that $s \in (\sqrt{2}, 2]$ is such that c is not recurrent and not preperiodic. For every $\delta > 0$ there exists $\varepsilon > 0$ with the following property: if $c \in J \subset [c_2, c_1]$ is an interval with midpoint m , and $|c - \partial J| \geq 5\delta$, then for each $n \geq 0$, either $T_s^n|_J$ is not ε -symmetric or $|c - m| \leq \varepsilon s^{-n}$.*

Proof. Fix $\delta > 0$ and let $\varepsilon = \varepsilon(\delta) > 0$ be chosen as in Proposition 4.29 and additionally such that $T_s^n(c) \notin (c - \varepsilon, c + \varepsilon)$ for all $n \geq 1$, which is possible because c is not recurrent.

If $|c - m| > \delta$, then we use Proposition 4.29 to conclude that $T_s^n|_J$ is not ε -symmetric. Assume by contradiction that $T_s^n|_J$ is ε -symmetric and $\varepsilon s^{-n} < |c - m| \leq \delta$. The choice of ε implies that T_s^n is monotone on a one-sided neighbourhood of c of length εs^{-n} , and maps it therefore onto an interval of length ε . This means that $T_s^n([c, m])$ has length at least ε , so that c and m must be distinct centres of ε -symmetry of T_s^n . Therefore $c^1 := \bar{R}_m(c) \in J$ is another center of ε -symmetry, and so is $c^2 := \bar{R}_{c^1}(c)$. Let $c^{i+2} := \bar{R}_{c^i}(c^{i+1})$ for every $i \in \mathbb{N}$ so that $c^{i+2} \in [c_2, c_1]$. Take the smallest $N \in \mathbb{N}$ so that the center of ε -symmetry c^N of T_s^n is satisfying $|c - c^N| > \delta$. Since $|c - c^{N-1}| < \delta$, it follows that $|c - c^N| < 2\delta$. We conclude that $c^N \in J$, because we assumed that $|c - \partial J| \geq 5\delta$. Define the interval $J' := [a, b]$, where $a, b \in J$ are chosen such that $|a - c^N| = |b - c^N|$ is the largest such that $[a, b] \subset J$. Therefore, c^N is the center of ε -symmetry of $T_s^n|_{J'}$ and $c \in J'$. Since $|c - c^N| < 2\delta$ and $|c - \partial J| \geq 5\delta$, we conclude that $|c - \partial J'| > \delta$. Applying Proposition 4.29 for the interval J' we conclude that $T_s^n|_{J'}$ is not ε -symmetric, which is a contradiction. \square

Proposition 4.33. *Assume that $T_s^n|_J$ is ε -symmetric around $m \in J \subset [c_2, c_1]$ and $\text{diam}(T_s^n(J)) \geq \varepsilon$ for some $\varepsilon > 0$. Then there exists $i < n$ such that $|c - T_s^i(m)| < \varepsilon s^{i-n}$.*

Proof. Assume $T_s^n|_J$ is ε -symmetric around m and $|c - T_s^i(m)| \geq \varepsilon s^{i-n}$ for every $i < n$. Specifically, $T_s^{-i}(c) \cap (m - \varepsilon s^{-n}, m + \varepsilon s^{-n}) = \emptyset$ for every $i < n$. Therefore $T_s^n|_{(m - \frac{\varepsilon}{2}s^{-n}, m + \frac{\varepsilon}{2}s^{-n})}$ is injective and $\text{diam}(T_s^n((m - \frac{\varepsilon}{2}s^{-n}, m + \frac{\varepsilon}{2}s^{-n}))) = \varepsilon$. Since $\text{diam}(T_s^n(J)) \geq \varepsilon$ and $T_s^n|_J$ is ε -symmetric around m , it follows that $(m - \frac{\varepsilon}{2}s^{-n}, m + \frac{\varepsilon}{2}s^{-n}) \subset J$. Thus we get a contradiction with ε -symmetry of the interval J around m . \square

Chapter 4. The Core Ingram Conjecture

Corollary 4.34. *Suppose that c is not recurrent. Then there exists $\varepsilon > 0$ with the following property: if $j \geq 1$ and $J \subset [c_2, c_1]$ such that $J \supset (c_j - \varepsilon, c_j + \varepsilon)$, then $T_s^n|_J$ is not ε -symmetric with midpoint c_j for any $n \geq 0$.*

Proof. Let $\varepsilon > 0$ be such that $c_i \notin (c - \varepsilon, c + \varepsilon)$ for every $i \in \mathbb{N}$. By Proposition 4.33, if $T^n|_J$ is ε -symmetric around c_j , then there exists $N < n$ such that $|c - c_{j+N}| < \varepsilon s^{N-n} < \varepsilon$, which is a contradiction with the definition of ε . \square

Definition 4.35. *We say that the maps $f : J \rightarrow \mathbb{R}$ and $g : K \rightarrow \mathbb{R}$ for intervals $J, K \subset [c_2, c_1]$ are ε -close if there exists a homeomorphism $\psi : J \rightarrow K$ such that $|f(x) - g \circ \psi(x)| < \varepsilon$ for all $x \in J$, see Figure 4.11.*

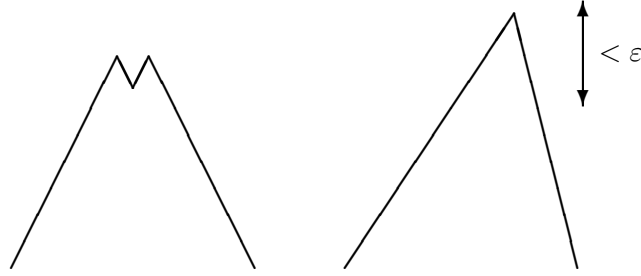

Figure 4.11: Graphs of ε -close maps.

Remark 4.36. *Maps that are ε -close can have different number of branches in general. However, in the non-recurrent case and for $\varepsilon > 0$ small enough, the number of branches must be the same, disregarding branches of the diameter less than ε that may appear at the ends of the interval. Note also that ε -closeness is not an equivalence relation because it is not transitive.*

Lemma 4.37. *Assume that the critical point c of the map T_s is not recurrent. Then there is $\varepsilon > 0$ such that, whenever $T_s^i|_{[c_2, c_1]}$ and $T_s^j|_{[a, b]}$ are ε -close for some interval $[a, b] \subset [c_2, c_1]$, there is a closed interval $J' := [a', b'] \subset [c_2, c_1]$ such that $|a' - a|, |b' - b| < \varepsilon$ so that T_s^{j-i} maps J' homeomorphically onto $[c_2, c_1]$.*

Remark 4.38. *The closed interval J' addresses the technicality that if e.g. $i = j = 0$ and $a = c_2 + \varepsilon/2$, $b = c_1 - \varepsilon/2$, then $T_s^i|_{[c_2, c_1]}$ and $T_s^j|_{[a, b]}$ are ε -close, but without the adjustment of $J' = [c_2, c_1]$, the lemma would fail.*

Chapter 4. The Core Ingram Conjecture

Proof. Take $\varepsilon = \frac{1}{100} \inf\{|c - c_n| : n \geq 1\}$. Assume that $T_s^i|_{[c_2, c_1]}$ and $T_s^j|_{[a, b]}$ are ε -close, with a homeomorphism $\psi : [a, b] \rightarrow [c_2, c_1]$ as in Definition 4.35.

If $i > j$, then $T_s^i|_{[c_2, c_1]}$ has more branches than $T_s^j|_{[a, b]}$, so they cannot be ε -close. If $i = j$, then there is nothing to prove. Therefore $i < j$.

Suppose that $T_s^{j-i}|_{[a, b]}$ is a homeomorphism onto a subinterval of $[c_2, c_1]$. If $T_s^{j-i}([a, b]) \supset [c_2 + \varepsilon s^{-i}, c_1 - \varepsilon s^{-i}]$, then (since by non-recurrence of c , the point c_n cannot be εs^{-i} -close to c_2 or c_1 for every $n > 2$) we can adjust the interval $[a, b]$ to $[a', b']$ so that $T_s^{j-i}([a', b']) \supset [c_2, c_1]$. In this case, the lemma is proved. If on the other hand $T_s^{j-i}([a, b]) \not\supset [c_2 + \varepsilon s^{-i}, c_1 - \varepsilon s^{-i}]$, then $T_s^j|_{[a, b]}$ cannot be ε -close to $T_s^i|_{[c_2, c_1]}$.

Now we assume that $T_s^{j-i}|_{[a, b]}$ is not a homeomorphism onto a subinterval of $[c_2, c_1]$. Since $T_s^{j-i}([a, b]) \subset [c_2, c_1]$, there is $t \in [a, b]$ such that $x := \psi(t) = T_s^{j-i}(t) \in [c_2, c_1]$; let $U \ni t$ be the maximal closed interval in $[a, b]$ such that $T_s^{j-i}|_U$ is monotone.

Take $t' \in \partial U \setminus \{a, b\}$ closest to t , so that $T_s^{j-i}(t') = c_n$ for some $n \geq 1$. Let U' be the maximal neighbourhood of t' such that $T_s^{j-i}(U')$ is contained in an ε -neighbourhood V of c_n . It follows that $T_s^j|_{U'}$ is ε -symmetric (see Figure 4.12).

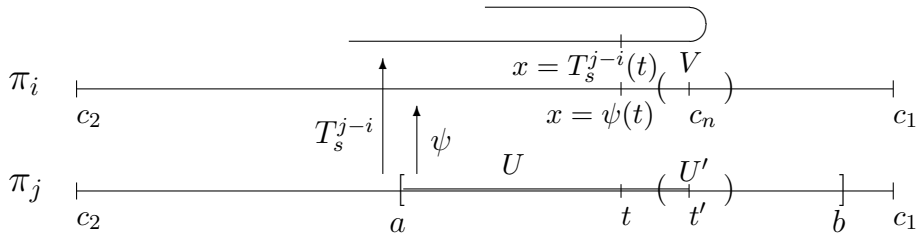

Figure 4.12: Step in the proof of Lemma 4.37.

If $\psi|_U$ and $T_s^{j-i}|_U$ have the same orientation, then, by ε -closeness, $|T_s^i(\psi(y)) - T_s^j(y)| < \varepsilon$ for all $y \in U$, which means that $|T_s^{j-i}(y) - \psi(y)| < \varepsilon s^{-i}$ for all $y \in U$. However, $T_s^i|_V$ is not ε -symmetric due to Corollary 4.34, and therefore the ε -closeness is violated on the set U' .

On the other hand, if $\psi|_U$ and $T_s^{j-i}|_U$ have opposite orientation, then T_s^i is ε -symmetric on a neighbourhood of x , with c_n in its closure. Let V' be the mirror image of V when reflected in x . Then by the ε -symmetry of T_s^i around x and around c_n , T_s^i has to be ε -symmetric on V' as well. But this contradicts Corollary 4.34 again, completing the proof. \square

Definition 4.39. *Let $A, B \subset X'_s$ be arcs with k -patterns P_A and P_B respectively, $\text{mesh}(\mathcal{C}_k) < \varepsilon$. We say that k -patterns P_A and P_B are ε -close if there exist $i, j \in \mathbb{N}$ such that $\pi_{k+i}|_A$ and $\pi_{k+j}|_B$ are injective on $[c_2, c_1]$ and $T^i|_{\pi_{k+i}(A)}$ and $T^j|_{\pi_{k+j}(B)}$ are ε -close maps.*

In the following remark we paraphrase the statement of Lemma 4.37 in the context of X'_s as it is going to be used in the proof of Theorem 4.43.

Remark 4.40. *Fix $\varepsilon > 0$ as in the proof of Lemma 4.37 and take $k \in \mathbb{N}$ such that $\text{mesh}(\mathcal{C}_k) < \varepsilon$. Assume that $n \in \mathbb{N}$ and $Q, Q' \subset X'_s$ are arcs with $(k+n)$ -patterns P and P' respectively where $P = 12$. Lemma 4.37 claims that if the k -patterns of Q and Q' are ε -close, then $P' = 12$ (or 21 depending on the orientation).*

4.6 Topological uniqueness of \mathfrak{R}

In this section we prove that \mathfrak{R} is fixed under homeomorphisms, provided that the critical orbit is non-recurrent.

From now on assume that $\sqrt{2} < s \neq \tilde{s} \leq 2$ and that tent maps T_s and $T_{\tilde{s}}$ have non-recurrent infinite critical orbits.

Assume by contradiction that there exists a homeomorphism $h : X'_s \rightarrow X'_{\tilde{s}}$. Our goal in this section is to prove Theorem 4.43 (which holds also if $s = \tilde{s}$).

Set

$$\delta_0 := \frac{1}{100} \inf\{|c - c_n|, |\tilde{c} - \tilde{c}_n| : n \geq 1\}. \quad (4.2)$$

Note that the non-recurrence of c and \tilde{c} imply that $\delta_0 > 0$. Take $\varepsilon = \varepsilon(\delta_0) > 0$ such that Proposition 4.29, Proposition 4.31, Proposition 4.32, Corollary 4.34 and Lemma 4.37 all apply for both X_s and $X_{\tilde{s}}$.

Chapter 4. The Core Ingram Conjecture

Choose integers k', l, k so large that $\text{mesh}(\mathcal{C}_{k'}), \text{mesh}(\tilde{\mathcal{C}}_l), \text{mesh}(\mathcal{C}_k) < \varepsilon$ and

$$h^{-1}(\tilde{\mathcal{C}}_l) \preceq \mathcal{C}_{k'} \quad \text{and} \quad h(\mathcal{C}_k) \preceq \tilde{\mathcal{C}}_l. \quad (4.3)$$

Let $B_i := h(A_i) = [h(\hat{m}_{i+2}), h(m_{i+2})]$ for every $i \in \mathbb{N}_0$; since $h(\mathcal{C}_k)$ refines $\tilde{\mathcal{C}}_l$, B_i is link-symmetric in $\tilde{\mathcal{C}}_l$. If B_i is not contained in a single link of $\tilde{\mathcal{C}}_l$, we denote its midpoint by n_i . Note that $h(m_i) \in A^{n_i}$ for every $i \in \mathbb{N}$. We denote $R_{n_i}(n_{i+2})$ by \hat{n}_{i+2} , see Figure 4.16. Note also that $h(\hat{m}_{i+2}) \in A^{\hat{n}_{i+2}}$. Let $(\dots q_{-2}, q_{-1}, q_0) = q := h(\rho)$.

Lemma 4.41. *The sequence $\{B_i\}_{i \in \mathbb{N}} \subset \varprojlim([c_2, c_1], T_{\bar{s}})$ is an eventual complete sequence of l -link symmetric arcs with respect to q , in the sense that for every l -link symmetric arc with midpoint n and containing q , either $n = n_i$ for some $i \in \mathbb{N}$ or $n \in (n_1, n_2)$.*

Proof. Assume by contradiction that there exists an l -link-symmetric arc $B \ni q$ with midpoint $n \in h(\mathfrak{R})$ such that $n \neq n_i$ for every $i \in \mathbb{N}$, $n \notin (n_1, n_2)$ and B is not contained in a single link of the chain $\tilde{\mathcal{C}}_l$. Take B such that n is the closest to q (in arc-length) with the above properties. There exists $j \in \mathbb{N}$ such that $n \in (n_j, n_{j+2})$.

Because we chose chains such that $h^{-1}(\tilde{\mathcal{C}}_l) \preceq \mathcal{C}_{k'}$, the arc $A := h^{-1}(B)$ is k' -link symmetric and $\rho \in A$.

Throughout this proof we use A^u to denote the arc-component of u in ℓ for a k' -point $u \in \ell \in \mathcal{C}_{k'}$.

Assume that the midpoint m of A is not contained in A^{m_j} or $A^{m_{j+2}}$, thus $m \in (m_j, m_{j+2})$ and $m_j \in A$. Note that $\mathcal{C}_k = h^{-1} \circ h(\mathcal{C}_k) \preceq h^{-1}(\tilde{\mathcal{C}}_l) \preceq \mathcal{C}_{k'}$ and thus $k \geq k'$. We conclude that every k -point is a k' -point. Specifically, m_j is a k' -point and since A^ρ contains no k' -points, it is easy to see that A is not contained in a single link of $\mathcal{C}_{k'}$. Since $\{A_i\}_{i \in \mathbb{N}}$ is a complete sequence of k -link symmetric arcs with respect to ρ , we get that $\{A_{i+k-k'}\}_{i \in \mathbb{N}}$ is a complete sequence of k' -link symmetric arcs with respect to ρ . Thus $m = m_{i+k-k'}$ for some $i \geq 1$. But $m = m_{i+k-k'} \in (m_j, m_{j+2})$ gives a contradiction.

Chapter 4. The Core Ingram Conjecture

If $m \in A^{m_j}$, then by the definition of a midpoint we conclude that $m = m_j$ and thus $A^n \ni h(m) = h(m_j) \in A^{n_j}$. Since n and n_j are both midpoints and $A^n = A^{n_j}$, we conclude that $n = n_j$. An analogous argument shows that if $m \in A^{m_{j+2}}$ then $n = n_{j+2}$. \square

Recall that $\tilde{\mathfrak{X}}$ is the arc-component in $X_{\tilde{s}}$ containing $\tilde{\rho} = (\dots, \tilde{r}, \tilde{r}, \tilde{r})$, where $\tilde{r} = \frac{\tilde{s}}{\tilde{s}+1}$ is a fixed point of $T_{\tilde{s}}$.

Assume by contradiction that $h(\mathfrak{X}) \neq \tilde{\mathfrak{X}}$, so in particular $h(\mathfrak{X}) \not\ni \tilde{\rho}$.

Assume also by contradiction that there exists $N \in \mathbb{N}$ such that the projections $q_{-i} > \tilde{c}$ for all $i \geq N$. Then the coordinates of $\sigma^{-N}(q)$ and $\tilde{\rho}$ are all obtained using the same right inverse branch of $T_{\tilde{s}}$. Thus $\sigma^{-N}(q)$ and $\tilde{\rho}$ are connected by an arc, and hence $h(\mathfrak{X}) \ni \tilde{\rho}$, a contradiction. Therefore $q_{-i} < c$ infinitely often. Analogously as above it follows that $q_{-i} > \tilde{c}$ infinitely often, because a fixed point $\bar{0} \notin h(\mathfrak{X})$.

Therefore, there is $l' > l+1$ such that $q_{-(l'+1)} < \tilde{c} < q_{-l'}$ and $\pi_{l'} : B_1 \rightarrow [\tilde{c}_2, \tilde{c}_1]$ is injective, where $B_1 = h(A_1)$.

The crux of the proof is to show that $h(\mathfrak{X})$ cannot contain the l' -pattern 12, and therefore by Lemma 4.12 cannot be dense in X'_s , which contradicts the fact that \mathfrak{X} is dense in X'_s .

Let $B \ni q$ be the maximal arc such that $\pi_{l'} : B \rightarrow [\tilde{c}_2, \tilde{c}_1]$ is injective. Therefore, $\pi_{l'+1}(B) \not\ni c$. Since $q_{-(l'+1)} \in \pi_{l'+1}(B)$ and $q_{-(l'+1)} < c$, it follows that $\pi_{l'+1}(B) \subset [\tilde{c}_2, \tilde{c}]$. Hence $\pi_{l'}(B) \subset T_{\tilde{s}}([\tilde{c}_2, \tilde{c}]) = [\tilde{c}_3, \tilde{c}_1]$, see Figure 4.13.

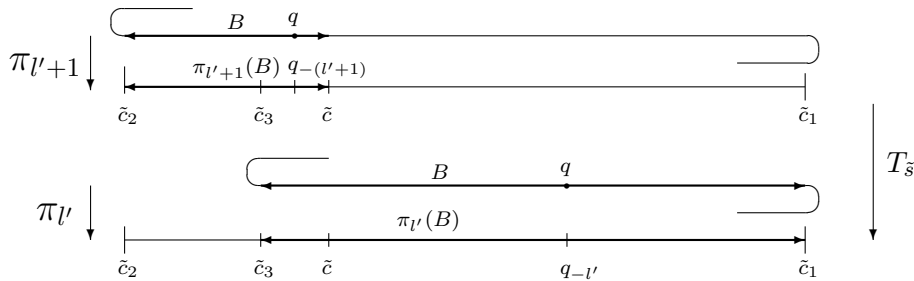

Figure 4.13: Arc B in projections $\pi_{l'+1}$ and $\pi_{l'}$.

Chapter 4. The Core Ingram Conjecture

Let $Q \subset h(\mathfrak{A})$ be the closest (in the arc-length distance) arc to q such that $\pi_{\nu'} : Q \rightarrow [\tilde{c}_2, \tilde{c}_1]$ is a bijection. It follows that $q \notin Q$.

Lemma 4.42. *Assume that an arc $Q \subset h(\mathfrak{A})$ is such that $\pi_{\nu'} : Q \rightarrow [\tilde{c}_2, \tilde{c}_1]$ is a bijection. If $Q \subset B_j$ for $j \in \mathbb{N}$ minimal, then $Q \subset [n_j, n_{j+2}]$.*

Proof. Let us assume by contradiction that n_j is in the interior of Q . Note that $\pi_{\nu'}(Q) = [\tilde{c}_2, \tilde{c}_1]$ and $\pi_{\nu'}(n_j) \neq \tilde{c}_1, \tilde{c}_2$. Let δ_0 be chosen as in the equation (4.2).

Note that $q \notin Q$, but $q \in B_j$.

Take the largest (in arc-length) arc $Q' \subset Q \subset B_j$ which is l -link symmetric with midpoint n_j and note that $\pi_{\nu'}|_{Q'}$ is injective. Let $[a, b] := \pi_{\nu'}(Q')$ and note that either $a = \tilde{c}_2$ or $b = \tilde{c}_1$. Assume that $b = \tilde{c}_1$. Let us study $T_{\tilde{s}}^{-1}([a, b])$.

Note that $T_{\tilde{s}}^{-1}(b) = T_{\tilde{s}}^{-1}(\tilde{c}_1) = \tilde{c}$ and denote by a_{-1} the endpoint of $T_{\tilde{s}}^{-1}([a, b])$ such that $a_{-1} \in (\tilde{c}, \tilde{c}_1]$. Let $Q'' \subset B_j$ be the largest (in arc-length) l -link symmetric arc with midpoint n_j and such that $\pi_{\nu'+1}|_{Q''}$ is injective. Note that $[\tilde{c}, a_{-1}] \subset \pi_{\nu'+1}(Q'')$. Since $Q \subset B_j$ and $|\tilde{c} - \tilde{c}_n| > 100\delta_0$ for every $n \in \mathbb{N}$, the interval $J := [\tilde{c} - 5\delta_0, a_{-1}]$ is also contained in $\pi_{\nu'+1}(Q'')$. See Figure 4.14.

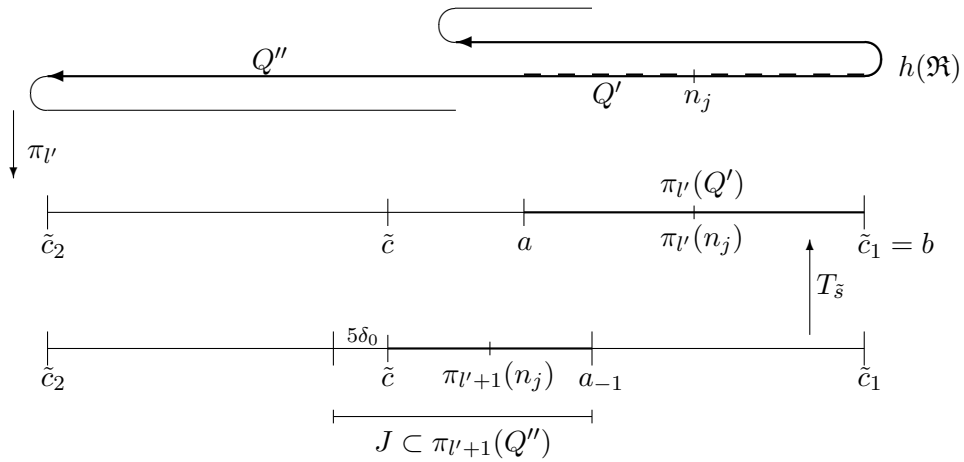

Figure 4.14: Projections of arcs from the proof of Lemma 4.42; arc Q' is denoted with dashed line and is contained in arc Q'' which is denoted with thick line.

Case I: Assume that $|a_{-1} - \tilde{c}_1| > 5\delta_0$.

Chapter 4. The Core Ingram Conjecture

- If $|\pi_{l'+1}(n_j) - \tilde{c}| > \varepsilon s^{-(l'-l+1)}$, then there exists an interval $J' \supset J$ with midpoint $\pi_{l'+1}(n_j)$ which satisfies conditions of Proposition 4.32, so $T_{\tilde{s}}^{l'-l+1}|_{J'}$ is not ε -symmetric around $\pi_{l'+1}(n_j)$, which contradicts the l -link symmetry of Q'' .
- If $|\pi_{l'+1}(n_j) - \tilde{c}| \leq \varepsilon s^{-(l'-l+1)}$, then there is a point $u \in A^{n_j}$ such that $\pi_{l'+1}(u) = \tilde{c}$. Since $\pi_{l'}(n_j) \neq \tilde{c}_1$, we have $\pi_{l'+1}(n_j) \neq \tilde{c}$ and thus $u \neq n_j$. Note that the l -level of u is greater than the l -level of n_j , which is a contradiction to the definition of midpoint.

Case II: Assume that $|a_{-1} - \tilde{c}_1| \leq 5\delta_0$.

Then $|a - \tilde{c}_2| \leq 5\delta_0 s \leq 10\delta_0$, so $|a - \tilde{c}| > 5\delta_0$.

- If $|\pi_{l'}(n_j) - \tilde{c}| > \varepsilon s^{-(l'-l)}$, then by Proposition 4.32 we get a contradiction with the l -link symmetry of Q' .
- If $|\pi_{l'}(n_j) - \tilde{c}| \leq \varepsilon s^{-(l'-l)}$, then $\pi_{l'}(n_j) = \tilde{c}$, because otherwise we get a contradiction with the definition of midpoint as above. But if $\pi_{l'}(n_j) = \tilde{c}$, then $T_{\tilde{s}}^{l'-l}|_{[a, \tilde{c}_1]}$ is ε -symmetric around \tilde{c} . However, since $|\tilde{c}_2 - T_{\tilde{s}}(a)| > |\tilde{c}_2 - \tilde{c}_3| > 100\delta_0 > \varepsilon$ it follows that $\text{diam}(T_{\tilde{s}}^{l'-l-1}([\tilde{c}_2, T_{\tilde{s}}(a)])) > \varepsilon$ (see Figure 4.15). Because $T_{\tilde{s}}|_{[a, \tilde{c}_1]}$ maps 2-to-1 on the interval $[T_{\tilde{s}}(a), \tilde{c}_1]$ and bijectively onto $[\tilde{c}_2, T_{\tilde{s}}(a)]$ we get a contradiction with $T_{\tilde{s}}^{l'-l}|_{[a, \tilde{c}_1]}$ being ε -symmetric around \tilde{c} . See Figure 4.15.

If $a = \tilde{c}_2$ we study $T_{\tilde{s}}^{-2}([a, b])$ and proceed similarly as in the preceding paragraphs. □

Theorem 4.43. *Let $\sqrt{2} < s \leq \tilde{s} \leq 2$ and assume that the critical points of T_s and $T_{\tilde{s}}$ are not recurrent. Let $\mathfrak{R} \subset X_s$ and $\tilde{\mathfrak{R}} \subset X_{\tilde{s}}$ be as above. If $h : X'_s \rightarrow X'_{\tilde{s}}$ is a homeomorphism, then $h(\mathfrak{R}) = \tilde{\mathfrak{R}}$.*

Proof. Let $Q \subset h(\mathfrak{R})$ be an arc with l' -pattern 12. Such Q exists by Lemma 4.12. Without loss of generality, we can assume that $\pi_{l'} : Q \rightarrow [\tilde{c}_2, \tilde{c}_1]$ is bijective. As we already observed, $q \notin Q$. Assume without loss of generality that Q is closest to q , in the sense that there is no other arc with l' -pattern 12 closer to q in arc-length distance.

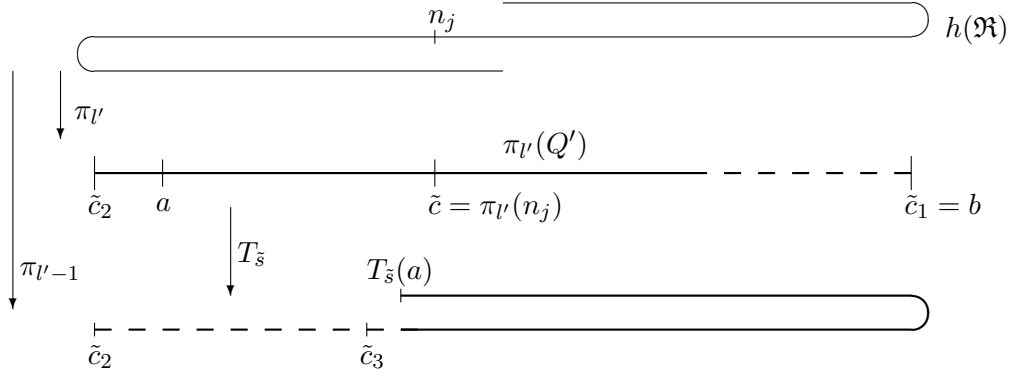

Figure 4.15: Step in the proof of Lemma 4.42, case $\pi_{l'}(n_j) = \tilde{c}$. Since the dashed interval is long, its image under $T_{\tilde{s}}^{l'-l-1}$ is longer than ε .

Let P be the l -pattern of Q ; it is the $T_{\tilde{s}}^{l'-l}$ -image of the l' -pattern 12.

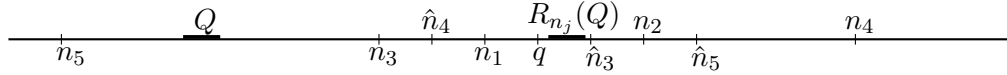

Figure 4.16: The midpoints and endpoints of l -link symmetric arcs $[n_i, \hat{n}_i]$.

Now let j be the minimal natural number such that $Q \subset B_j$. Then $Q \subset [n_j, n_{j+2}]$ by Lemma 4.42. Since B_j is l -link-symmetric around n_j , we can reflect Q in n_j , obtaining the arc $R_{n_j}(Q) \subset h(\mathfrak{R})$ which has l -pattern ε -close to P (see Figure 4.16). Lemma 4.37 implies that $R_{n_j}(Q)$ has l' -pattern 12, contradicting the choice of Q . Thus there exists no arc $Q \subset h(\mathfrak{R})$ with l -pattern P , which contradicts that $h(\mathfrak{R})$ is dense in X'_s (Lemma 4.12). \square

4.7 The main theorem

Note that once we know that the arc-component \mathfrak{R} is fixed under homeomorphisms, the results from this section follow without the non-recurrence assumption. We prove that the patterns of link-symmetric arcs in \mathfrak{R} depend on the slope s . This idea, but on \mathfrak{C} , was used in [10].

Recall that $p \in \varprojlim([c_2, c_1], T_s)$ is called a k -point if there exists $n > 0$ such

Chapter 4. The Core Ingram Conjecture

that $\pi_{k+n}(p) = c$, and we write $L_k(p) = n$.

Definition 4.44. *Let $\mathfrak{U} \subset X_s$ be an arc-component and $u \in \mathfrak{U}$. We say that a k -point $p \in \mathfrak{U}$ such that $L_k(p) = n$ is a salient k -point with respect to u if $\pi_{k+n}|_{[u,p]}$ is injective.*

Remark 4.45. *The above definition says that a salient point p is a k -point of level n and that there are no k -points between u and p with k -level greater than n . Thus it corresponds to the existent definition of a salient point (for example in [10]). We will work with salient k -points with respect to $\rho, \tilde{\rho}$ or q but because it is clear with respect to which point we work we refer to them only as salient k (or l)-points.*

Lemma 4.46. *For any $i \in \mathbb{N}$, the midpoint m_i of $A_i \subset \mathfrak{R}$ is a salient k -point with respect to ρ and its k -level is i .*

Proof. By the definition of A_i , we obtain that $\rho \in A_i$, $\pi_{k+i}(m_i) = c$ and $\pi_{k+i}|_{A_i}$ is injective onto $[c_2, \hat{c}_2]$. This proves the claim. \square

We consider l -link symmetric arcs $B_i = h(A_i) \subset \tilde{\mathfrak{R}}$, where the chains \mathcal{C}_k and $\tilde{\mathcal{C}}_l$ satisfy (4.3). Let $\tilde{A}_i \subset \tilde{\mathfrak{R}} \subset X_{\tilde{s}}$ be the arc-component of $\pi_{l+i}^{-1}([\tilde{c}_2, \hat{\tilde{c}}_2])$ containing $\tilde{\rho}$ for every $i \in \mathbb{N}$. The arcs \tilde{A}_i are all l -symmetric with salient l -points \tilde{m}_i of level i and they form a complete sequence with respect to $\tilde{\rho} = (\dots, \tilde{r}, \tilde{r})$.

Let n_i and \tilde{m}_i be the midpoints of arcs B_i and \tilde{A}_i respectively. In the next two lemmas we show how B_i and \tilde{A}_i relate to each other.

Lemma 4.47. *There exists $N \in \mathbb{N}$ such that for every $j \geq N$ there exists $j' \in \mathbb{N}$ such that $\tilde{\rho} \in B_j$, $q = h(\rho) \in \tilde{A}_{j'}$ and $n_j = \tilde{m}_{j'} \notin [\tilde{\rho}, q]$ for every $j \geq N + 2$.*

Proof. By Lemma 4.23 and applying h we obtain that $\cup_{i \text{ odd}} B_i = \cup_{i \text{ even}} B_i = \tilde{\mathfrak{R}}$ and $B_i \subset B_{i+2}$ for every $i \in \mathbb{N}$, so there exists N such that $[\tilde{\rho}, q] \subset B_j$ for all $j \geq N$. Lemma 4.25 implies that $n_j \notin [\tilde{\rho}, q]$ for $j \geq N + 2$. The argument for the arcs \tilde{A}_i is analogous. Because $\{\tilde{A}_i\}$ is the complete sequence for $\tilde{\mathfrak{R}}$ with respect to $\tilde{\rho}$ it follows that $n_j = \tilde{m}_{j'}$. \square

Chapter 4. The Core Ingram Conjecture

Definition 4.48. Given an arc $A = [u, v] \subset X_s$, we call the arc-component of $A \cap \ell$ of u (where the link $\ell \ni u$) the link-tip of A at u . Similarly for v . Let $A^{-\ell} = A \setminus \{\text{link-tips}\}$. We say that two arcs A and B are close if $A^{-\ell} = B^{-\ell}$ and denote it by $A \approx B$.

Lemma 4.49. There exists $N \in \mathbb{N}$ such that for every $j \geq N$ there exists $j' \in \mathbb{N}$ such that $B_j \approx \tilde{A}_{j'}$.

Proof. Take N from Lemma 4.47. Assume by contradiction that there exists $j \geq N$ such that $B_j \not\approx \tilde{A}_{j'}$ for every $j' \in \mathbb{N}$. By the completeness of $\{\tilde{A}_i\}_{i \in \mathbb{N}}$, there exists some $j' \in \mathbb{N}$ such that $n_j = \tilde{m}_{j'}$. As B_j and $\tilde{A}_{j'}$ are both l -link symmetric with the same midpoint, either $B_j^{-\ell} \subsetneq \tilde{A}_{j'}^{-\ell}$ or $\tilde{A}_{j'}^{-\ell} \subsetneq B_j^{-\ell}$, where $A^{-\ell}$ and $B^{-\ell}$ are as in the Definition 4.48. Assume that $B_j^{-\ell} \subsetneq \tilde{A}_{j'}^{-\ell}$. Note that since $n_j = \tilde{m}_{j'} \notin [\tilde{\rho}, q]$ we obtain that $n_{j+2} \in (\tilde{m}_{j'}, \tilde{m}_{j'+2})$. But then B_{j+2} would be l -link-symmetric and contain q and $\tilde{\rho}$, and since the midpoint of B_{j+2} lies in $(\tilde{m}_{j'}, \tilde{m}_{j'+2})$, this contradicts the completeness of $\{\tilde{A}_i\}_{i \in \mathbb{N}}$. The second case follows similarly, but instead of the completeness of $\{\tilde{A}_i\}_{i \in \mathbb{N}}$ we use the eventual completeness of sequence $\{B_i\}_{i \in \mathbb{N}}$, see Lemma 4.41. \square

Proposition 4.50. There exist $N, M \in \mathbb{N}$ such that $L_l(n_{N+i}) = i + M$ for every $i \in \mathbb{N}_0$.

Proof. Take N from Lemma 4.47. There exist $j', j'' \in \mathbb{N}_0$ such that:

$$B_N \approx \tilde{A}_{j'}, B_{N+2} \approx \tilde{A}_{j'+2}, B_{N+4} \approx \tilde{A}_{j'+4}, \dots$$

$$B_{N+1} \approx \tilde{A}_{j''}, B_{N+3} \approx \tilde{A}_{j''+2}, B_{N+5} \approx \tilde{A}_{j''+4}, \dots$$

or in terms of l -levels $L_l(n_{N+2i}) = j' + 2i$, $L_l(n_{N+2i+1}) = j'' + 2i$ for all $i \in \mathbb{N}_0$. So far we only know that j' and j'' must be of different parity. Assume $j'' > j'$, so there exists an odd natural number $j \geq 1$ such that $j'' = j' + j$. Since $B_N = h(A_N) \not\subseteq h(A_{N+1}) = B_{N+1}$, we conclude from Lemma 4.24 that $j < \xi$. Assume by contradiction that $j > 1$ and take $i = \xi - j$. From Lemma 4.24 we obtain that $\tilde{A}_{j'} \subseteq \tilde{A}_{j'+\xi}$. But $\tilde{A}_{j'} \approx B_N$, $\tilde{A}_{j'+\xi} = \tilde{A}_{j'+j+i} = \tilde{A}_{j''+i} \approx B_{N+i+1}$. Thus we get $h(A_N) = B_N \subseteq B_{N+i+1} = h(A_{N+i+1})$ which is a contradiction because $i + 1 < \xi$ and $i + 1$ odd. We conclude that $j = 1$.

Chapter 4. The Core Ingram Conjecture

The other possibility is that $j'' < j'$. Since also $B_{N+1} = h(A_{N+1}) \not\subseteq h(A_N) = B_N$, we conclude that $j' = j'' + j$, where $j < \xi$ odd. Recall that $\tilde{A}_{j''} \subseteq \tilde{A}_{j''+\xi}$, but $\tilde{A}_{j''} \approx B_{N+1}$ and $\tilde{A}_{j''+\xi} \approx B_{N+\xi-j}$, where $\xi - j \in \mathbb{N}$ is even. Thus there exists an even natural number $0 < i < \xi$ such that $B_{N+1} \subseteq B_{N+i}$, which is again a contradiction.

So the only possibility is $j'' = j' + 1$, which gives $B_{N+i} \approx \tilde{A}_{j'+i}$ for every $i \in \mathbb{N}_0$ and this finishes the proof. \square

So far we have shown that there exist $N, M \in \mathbb{N}$ such that a homeomorphism h maps the salient point of k -level $i + N$ close to the salient point of l -level $i + M$ for every $i \in \mathbb{N}_0$. Here *close to* means that $h(m_{i+N})$ is in the same link of $\tilde{\mathcal{C}}_l$ as \tilde{m}_{i+M} and the arc-component of the link containing point \tilde{m}_{i+M} also contains the point $h(m_{i+N})$. Note that this works for any k and l such that $h(\mathcal{C}_k) \preceq \tilde{\mathcal{C}}_l$. The salient $(k + N)$ -point of $(k + N)$ -level i is the salient k -point of k -level $i + N$. Therefore, if we consider \mathcal{C}_{k+N} instead of \mathcal{C}_k , then $h(m_i)$ is close to \tilde{m}_{i+M} for every $i \geq 1$.

The proof of the Core Ingram Conjecture now follows analogously as in [37]. We first need to prove that a homeomorphism h preserves the sequence of k -points and then argue that the sequences of k -points and l -points of \mathfrak{R} and $\tilde{\mathfrak{R}}$ respectively are never the same, unless $s = \tilde{s}$.

Proposition 4.51. *Let $n \in \mathbb{N}$ and $u \in \mathfrak{R}$ be a k -point with k -level n . Then $h(u) \in \tilde{\mathfrak{R}}$ is in the link of $\tilde{\mathcal{C}}_l$ that contains \tilde{m}_{n+M} and the arc-component of the link that contains $h(u)$ also contains an l -point v with l -level $n + M$ (see Figure 4.17).*

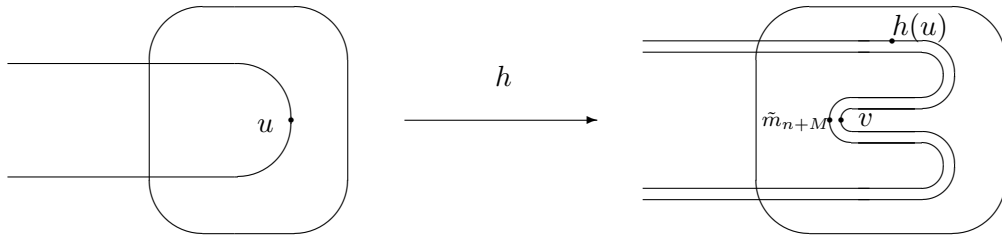

Figure 4.17: Claim of the Proposition 4.51.

Chapter 4. The Core Ingram Conjecture

Proof. For $i \in \mathbb{N}$ denote by S_i the longest arc in \mathfrak{R} containing m_i such that $\pi_{k+i}|_{S_i}$ is injective. Note that S_i is exactly the arc-component of $\pi_{k+i}^{-1}([c_2, c_1])$ which contains m_i and that $\pi_{k+i}(S_i) = [c_2, c_1]$. Also note that $A_i \subset S_i$ and the endpoint of A_i projecting with π_{k+i} to c_2 agrees with one endpoint of S_i . Let $S_i^\rho, S_i^{-\rho} \subset S_i$ be the arc-components of $\pi_{k+i}^{-1}([c, c_1])$ and of $\pi_{k+i}^{-1}([c_2, c])$ respectively, with m_i as the common boundary point. Note that $\rho \in S_i^\rho$ and its endpoints are m_i and m_{i+1} . Also, $\rho \notin S_i^{-\rho}$ and its endpoints are m_i and m_{i+2} . Also note that $S_i^{-\rho}$ is shorter (in arc-length) than S_i^ρ and that $S_{i+1}^\rho = S_i$. We will prove the proposition for k -points in S_i by induction on i . Note that all k -points in S_1 are salient, and by the remarks preceding this proposition it follows that the proposition holds for salient points. Assume that the proposition holds for all k -points in $S_i (= S_{i+1}^\rho)$. Take a k -point $u \in S_{i+1}^{-\rho} \setminus \{m_{i+1}, m_{i+3}\}$ with k -level n . Note that $n < i + 1$ by the definition of S_{i+1} . Also, since $S_{i+1}^{-\rho}$ is shorter than S_{i+1}^ρ there exists a k -point $R_{m_{i+1}}(u) \in S_{i+1}^\rho$ such that $[u, R_{m_{i+1}}(u)]$ is k -symmetric with midpoint m_{i+1} . Observe that $h([u, R_{m_{i+1}}(u)])$ is l -link symmetric with midpoint \tilde{m}_{i+1+M} , because it is the point with the highest l -level in the link containing $h(m_{i+1})$. Since $R_{m_{i+1}}(u) \in S_{i+1}^\rho = S_i$, $h(R_{m_{i+1}}(u))$ is in the link containing \tilde{m}_{n+M} and the arc-component of the link containing $h(R_{m_{i+1}}(u))$ contains an l -point v' such that $L_l(v') = n + M$. Take such v' closest (in arc-length) to \tilde{m}_{i+1+M} such that there are no points of l -level greater or equal than $i + 1 + M$ in (\tilde{m}_{i+1+M}, v') . Since $n < i + 1$, we obtain that $L_l(v') = n + M < i + 1 + M = L_l(\tilde{m}_{i+1+M})$. Note that there exists an l -point v such that the arc $[v, v']$ is l -symmetric with midpoint \tilde{m}_{i+1+M} . This implies that v and v' both have the same level $n + M$, and that they belong to the same link. Arc-component of the link containing v must also contain point $h(u)$.

This concludes the proof for every k -point in S_{i+1} . Since $\cup_i S_i = \mathfrak{R}$, this concludes the proof. \square

Proposition 4.52. *Let k, l, k' be such that $h(\mathcal{C}_k) \preceq \tilde{\mathcal{C}}_l \preceq h(\mathcal{C}_{k'})$ holds as in (4.3). Take $M, M' \in \mathbb{N}$ such that h maps every k -point with k -level n close to l -point with l -level $n + M$ and h^{-1} maps every l -point with l -level n close to k' -point with k' -level $n + M'$. Then for every $K \in \mathbb{N}$, there is an orientation*

Chapter 4. The Core Ingram Conjecture

preserving bijection between

$$\{u \in [m_K, m_{K+1}] : L_k(u) = n\} \text{ and } \{v \in [\tilde{m}_{K+M}, \tilde{m}_{K+1+M}] : L_l(v) = n+M\}.$$

Proof. First we claim that $M + M' = k - k'$. Take the salient k -point m_i with $L_k(m_i) = i$ and note that it is also a salient k' -point with $L_{k'}(m_i) = k + i - k'$. Note that by remarks before Proposition 4.51, homeomorphism h maps the salient k -point with level i close to the salient l -point with l -level $i + M$, which is mapped by h^{-1} close to the salient k' -point with k' -level $i + M + M'$. This means that the salient k' -point with k' -level $k + i - k'$ belongs to the same arc-component of the same link of the chain $\mathcal{C}_{k'}$ that contains the salient k' -point with k' -level $i + M + M'$. But this is only possible if the points are equal which implies that $M + M' = k - k'$.

Denote by z_i , $i = 1, \dots, a$, all k -points with k -level n in $[m_K, m_{K+1}]$ such that $m_K \prec z_1 \prec \dots \prec z_a \prec m_{K+1}$ (where $x \prec y \prec z$ if $[x, y] \subset [x, z]$ for $x, y, z \in \mathfrak{U} \subset X_s$). Similarly, denote by \tilde{z}_j , $j = 1, \dots, b$, all l -points with l -level $n + M$ in $[\tilde{m}_{K+M}, \tilde{m}_{K+1+M}]$ such that $\tilde{m}_{K+M} \prec \tilde{z}_1 \prec \dots \prec \tilde{z}_b \prec \tilde{m}_{K+1+M}$. We will first prove that $a \leq b$.

Recall that for an l -point u such that $u \in \ell \in \tilde{\mathcal{C}}_l$ we denote the arc-component of u in ℓ by A^u . We can find $N > 0$ such that $A^{\sigma^N(\tilde{m}_{K+M})}, A^{\sigma^N(\tilde{z}_1)}, \dots, A^{\sigma^N(\tilde{z}_b)}, A^{\sigma^N(\tilde{m}_{K+1+M})}$ are all different. Also, every point $u \in \{\sigma^N(\tilde{m}_{K+M}), \sigma^N(\tilde{z}_1), \dots, \sigma^N(\tilde{z}_b), \sigma^N(\tilde{m}_{K+1+M})\}$ has to be a midpoint of A^u . Otherwise, there would exist another l -point with l -level $n + M + N$ in the same arc-component which is impossible since we separated them. Since $\sigma^N(m_K) = m_{K+N}$ and $\sigma^N(\tilde{m}_{K+M}) = \tilde{m}_{K+M+N}$, we get from Proposition 4.51 that for every $i \in \{1, \dots, a\}$ there exists unique $j \in \{1, \dots, b\}$ such that $h(\sigma^N(z_i)) \in A^{\sigma^N(\tilde{z}_j)}$. This defines a function $x \mapsto \tilde{x}$ for every k -point $x \in [m_K, m_{K+1}]$ with $L_k(x) = n$ to an l -point $\tilde{x} \in [\tilde{m}_{K+M}, \tilde{m}_{K+M+1}]$ with $L_l(\tilde{x}) = n + M$. Note that we can take N such that σ^N preserves orientation and so $x \prec y$ implies $\tilde{x} \prec \tilde{y}$.

Next we want to prove that $x \mapsto \tilde{x}$ is injective. Assume there are $i_1, i_2 \in \{1, \dots, a\}$ such that $h(\sigma^N(z_{i_1})), h(\sigma^N(z_{i_2})) \in A^{\sigma^N(\tilde{z}_j)}$, for some $j \in \{1, \dots, b\}$.

Chapter 4. The Core Ingram Conjecture

There exists a k -point w such that $\sigma^N(z_{i_1}) \prec w \prec \sigma^N(z_{i_2})$ and such that $L_k(w) > n + N$. Note that $h(w) \in A^{\sigma^N(\tilde{z}_j)}$. But then there exists an l -point $\tilde{w} \in A^{\sigma^N(\tilde{z}_j)}$ with l -level strictly greater than $n + N + M$ which is in contradiction with $\sigma^N(\tilde{z}_j)$ being the center of the link. This proves that the above function $x \mapsto \tilde{x}$ is injective, *i.e.*, $a \leq b$.

It follows that

$$\begin{aligned} & \#\{k\text{-points in } [m_K, m_{K+1}] \text{ with } k\text{-level } n\} \\ & \leq \#\{l\text{-points in } [\tilde{m}_{K+M}, \tilde{m}_{K+1+M}] \text{ with } l\text{-level } n + M\} \\ & \leq \#\{k'\text{-points in } [m_{K+M+M'}, m_{K+1+M+M'}] \text{ with } k'\text{-level } n + M + M'\}. \end{aligned}$$

We proved that $M + M' = k - k'$ so the last number is equal to the number of k' -points in $[m_{K+k-k'}, m_{K+1+k-k'}]$ with k' -level $n + k - k'$. But this is actually equal to the number of k -points in $[m_K, m_{K+1}]$ with k -level n . This proves that $a = b$. \square

Recall a main theorem of this chapter, Theorem 1.3:

If $1 \leq s < \tilde{s} \leq 2$ and critical points of T_s and $T_{\tilde{s}}$ are non-recurrent, then the inverse limit spaces X'_s and $X'_{\tilde{s}}$ are not homeomorphic.

Proof of Theorem 1.3. We claim that the k -pattern of $[m_{n-1}, m_n]$ is equal to the $(l+M)$ -pattern of $[\tilde{m}_{n-1}, \tilde{m}_n]$ and that $T_s^n(c) > c$ if and only if $T_{\tilde{s}}^n(\tilde{c}) > \tilde{c}$ for every $n \geq 2$. This gives $s = \tilde{s}$.

The claim is obviously true for $n = 2$. For the inductive step, assume that it is true for all positive integers $< n$.

Specifically, the k -pattern of $[m_{n-2}, m_{n-1}]$ is the $(l+M)$ -pattern of $[\tilde{m}_{n-2}, \tilde{m}_{n-1}]$. Denote all k -points in $[m_{n-2}, m_{n-1}]$ by $m_{n-2} = z_0 \prec z_1 \prec \dots \prec z_i \prec z_{i+1} = m_{n-1}$. Denote all $(l+M)$ -points in $[\tilde{m}_{n-2}, \tilde{m}_{n-1}]$ analogously by $\tilde{m}_{n-2} = z_0 \prec \tilde{z}_1 \prec \dots \prec \tilde{z}_i \prec \tilde{z}_{i+1} = \tilde{m}_{n-1}$. Since patterns are the same, $L_k(z_j) = L_{l+M}(\tilde{z}_j)$ for all $j \in \{0, \dots, i+1\}$. By the inductive assumption it follows that $c \in \pi_k(z_j, z_{j+1})$ if and only if $\tilde{c} \in \pi_{l+M}(\tilde{z}_j, \tilde{z}_{j+1})$ for all $j \in \{0, \dots, i\}$.

Chapter 4. The Core Ingram Conjecture

Since $\sigma([m_{n-2}, m_{n-1}]) = [m_{n-1}, m_n]$ and every subarc $[z_j, z_{j+1}]$ is mapped to the subarc $[\sigma(z_j), \sigma(z_{j+1})]$ with k -pattern $L_k(z_j) + 1, 1, L_k(z_{j+1}) + 1$ or $L_k(z_j) + 1, L_k(z_{j+1}) + 1$ according to whether $\pi_k([z_{j-1}, z_j])$ contains c or not, inductive hypothesis for $n - 1$ completely determines the k -pattern of $[m_{n-1}, m_n]$. The same holds for the arc $[\tilde{m}_{n-2}, \tilde{m}_{n-1}]$. Since we assumed that $T_s^{n'}(c) > c$ if and only if $T_s^{n'}(\tilde{c}) > \tilde{c}$ for all $n' < n$, this gives that the k -pattern of $[m_{n-1}, m_n]$ is the same as the $(l + M)$ -pattern of $[\tilde{m}_{n-1}, \tilde{m}_n]$.

From now on we study $[m_{n-1}, m_n]$ and $[\tilde{m}_{n-1}, \tilde{m}_n]$. Write $m_{n-1} \prec z_1 \prec \dots \prec z_i \prec m_n$ and $\tilde{m}_{n-1} \prec \tilde{z}_1 \prec \dots \prec \tilde{z}_i \prec \tilde{m}_n$, where $\{z_1, \dots, z_i\} \subset \mathfrak{R}$ is the set of all k -points in $[m_{n-1}, m_n]$ and $\{\tilde{z}_1, \dots, \tilde{z}_i\} \subset \tilde{\mathfrak{R}}$ is the set of all $(l + M)$ -points in $[\tilde{m}_{n-1}, \tilde{m}_n]$. From the previous paragraph we obtain that $L_k(z_j) = L_{l+M}(\tilde{z}_j)$ for every $j \in \{1, \dots, i\}$.

Assume by contradiction that $T_s^n(c)$ and $T_s^n(\tilde{c})$ are on the different sides of c in $[c_2, c_1]$ and \tilde{c} in $[\tilde{c}_2, \tilde{c}_1]$ respectively. Since $\pi_k(m_n) = T_s^n(c)$ and $\pi_{l+M}(\tilde{m}_n) = T_s^n(\tilde{c})$, by assumption $c \in \pi_k((z_i, m_n))$ and $\tilde{c} \notin \pi_{l+M}((\tilde{z}_i, \tilde{m}_n))$ or the opposite. The inductive hypothesis gives $c \in \pi_k((z_j, z_{j+1}))$ if and only if $\tilde{c} \in \pi_{l+M}((\tilde{z}_j, \tilde{z}_{j+1}))$ for all $j \in \{1, \dots, i - 1\}$. Apply σ to $[m_{n-1}, m_n]$ and $[\tilde{m}_{n-1}, \tilde{m}_n]$ and count the number of k -points in $\sigma([m_{n-1}, m_n]) = [m_n, m_{n+1}]$ and the number of $(l + M)$ -points in $\sigma([\tilde{m}_{n-1}, \tilde{m}_n]) = [\tilde{m}_n, \tilde{m}_{n+1}]$. Every point of k -level strictly greater than 1 in $[m_n, m_{n+1}]$ is a shift of some z_j and every point of $(l + M)$ -level greater than 1 in $[\tilde{m}_n, \tilde{m}_{n+1}]$ is a shift of some \tilde{z}_j . So it suffices to count the k -points of k -level 1 in $[m_n, m_{n+1}]$ and the $(l + M)$ -points of $(l + M)$ -level 1 in $[\tilde{m}_n, \tilde{m}_{n+1}]$. Such points are obtained as shifts of points in $[m_{n-1}, m_n]$ (respectively $[\tilde{m}_{n-1}, \tilde{m}_n]$) which are projected to c by π_k (respectively to \tilde{c} by π_{l+M}). The number of such points in $[m_{n-1}, m_n]$ differs by one from the number of points in $[\tilde{m}_{n-1}, \tilde{m}_n]$, because by our assumption either $c \in \pi_k((z_i, m_n))$ or $\tilde{c} \in \pi_{l+M}((\tilde{z}_i, \tilde{m}_n))$, but not both. That is, the number of k -points of k -level 1 in $[m_n, m_{n+1}] = \sigma([m_{n-1}, m_n])$ is different from the number of $(l + M)$ -points of $(l + M)$ -level 1 in $[\tilde{m}_n, \tilde{m}_{n+1}] = \sigma([\tilde{m}_{n-1}, \tilde{m}_n])$ which contradicts Proposition 4.52. \square

Theorem 1.4 about the group of self-homeomorphisms extends as well. The

Chapter 4. The Core Ingram Conjecture

proof requires only minor adjustments: one needs to replace the arc-component \mathfrak{C} with \mathfrak{R} in the proof of [36, Theorem 1.3]. We recall it here:

Assume that T_s has a non-recurrent critical point. Then for every self-homeomorphism $h : X'_s \rightarrow X'_s$ there is $R \in \mathbb{Z}$ with h and σ^R isotopic.

Chapter 5

Planar embeddings of chainable continua

In this chapter we construct planar embeddings of chainable continua in full generality. It is well known that every chainable continuum (inverse limit on intervals) can be embedded in the plane, see [22]. In this chapter we develop methods to study non-equivalent planar embeddings, similar to the methods used by Lewis in [62] and Smith in [81] for the study of planar embeddings of the pseudo-arc. Following Bing's approach from [22] and Lemma 2.11, we construct nested intersections of discs which are small tubular neighbourhoods of polygonal lines obtained from the bonding maps. Later we show that this approach produces all possible embeddings of chainable continua which can be covered with planar chains with *connected* links. In this way we can produce non-equivalent planar embeddings of the same chainable continuum.

Definition 5.1. *Two embeddings $\varphi, \psi : X \rightarrow \mathbb{R}^2$ are called strongly equivalent if $\varphi \circ \psi^{-1} : \psi(X) \rightarrow \varphi(X)$ can be extended to a homeomorphism of \mathbb{R}^2 . They are weakly equivalent if there is a homeomorphism h of \mathbb{R}^2 such that $h(\varphi(X)) = \psi(X)$.*

Clearly strong equivalence implies weak equivalence, but in general not the other way around, see for instance Remark 5.50.

Recall Mayer's question from 1983 (Question 1.8):

Chapter 5. Planar embeddings of chainable continua

Are there uncountably many nonequivalent embeddings of every chainable indecomposable continuum?

This question is listed as Problem 141 in the collection of continuum theory problems from 1983 by Lewis [61] and was also posed by Mayer in his thesis in 1983 [67], without precisely specifying the definition of equivalent embeddings.

Throughout the chapter, we will use “equivalent” for “strongly equivalent”, and with this version of equivalent, we give a positive answer to the above question, see Theorem 5.44. If a continuum is the inverse limit space of a unimodal map and not hereditarily decomposable, then the result holds for both definitions of equivalent, see Remark 5.51.

This generalizes the result in [5], where we prove that every unimodal inverse limit space with bonding map of positive topological entropy can be embedded in the plane in uncountably many non-equivalent ways. The special construction in [5] uses the symbolic techniques which enables direct computation of accessible sets and prime ends, see [7]. Here we utilize a more geometric approach.

One of the motivations for this study is also the following long-standing open problem posed by Nadler and Quinn in 1972 (Question 1.6):

Let X be a chainable continuum and $x \in X$. Can X be embedded in the plane such that x is accessible?

Definition 5.2. *Let $X \subset \mathbb{R}^2$. We say that $x \in X$ is accessible (from the complement of X) if there exists an arc $A \subset \mathbb{R}^2$ such that $A \cap X = \{x\}$.*

We will introduce the notion of a *zigzag* related to the admissible permutations of graphs of bonding maps and answer the Nadler and Quinn question in the affirmative for a class of *non-zigzag* chainable continua (see Corollary 5.15). It is commonly believed that there should exist a counterexample to the question of Nadler and Quinn. The most promising example is the one suggested by Piotr Minc, see Figure 5.16. However, we still don’t know how to prove that point $p \in X_M$ cannot be made accessible (or how to make it accessible), even

with the use of thin embeddings, see Definition 5.27. The understanding of thick embeddings is even more lacking.

Remark 5.3. *In this Chapter all maps are considered to be continuous.*

5.1 Permuting the graph

Let $C = \{l_1, \dots, l_n\}$ be a chain of I and let $f : I \rightarrow I$ be a continuous surjection which is piecewise linear with finitely many critical points $0 = t_0 < t_1 < \dots < t_m < t_{m+1} = 1$ (so we include the endpoints of $[0, 1]$ in the set of critical points). Assume that $f([t_i, t_{i+1}])$ is not contained in a single link of C for every $i \in \{0, \dots, m\}$.

The line $H_0 \cup V_1 \cup H_1 \cup \dots \cup V_m \cup H_m =: G_f$ will be called the *flattened graph of f in \mathbb{R}^2* , where $H_j = f([t_j, t_{j+1}]) \times \{j\}$ for all $j \in \{0, \dots, m\}$ and $V_j = \{f(t_j)\} \times [j-1, j]$ for all $j \in \{1, \dots, m\}$. Note that H_{j-1} and H_j are joined at their left endpoints by V_j if t_j is a local minimum of f and they are joined at their right endpoints if it is a local maximum of f . See Figure 5.1.

Definition 5.4. *The permutation $p : \{0, 1, \dots, m\} \rightarrow \{0, 1, \dots, m\}$ is called C -admissible permutation of G_f if for every $i \in \{0, \dots, m-1\}$ and $k \in \{0, \dots, m\}$ such that $p(i) < p(k) < p(i+1)$ or $p(i+1) < p(k) < p(i)$ it holds that:*

- (a) $f(t_{i+1}) \notin f([t_k, t_{k+1}])$, or
- (b) $f(t_{i+1}) \in f([t_k, t_{k+1}])$ but $f(t_k)$ or $f(t_{k+1})$ is contained in the same link of C as $f(t_{i+1})$.

If p is a C -admissible permutation of G_f , define the permuted graph of f with respect to C as $p^C(G_f) = p(H_0) \cup p(V_1) \cup \dots \cup p(V_m) \cup p(H_m)$ such that $p(H_j) = f([\tilde{t}_j, \tilde{t}_{j+1}]) \times \{p(j)\}$ and $p(V_j) = \{f(\tilde{t}_j)\} \times [p(j-1), p(j)]$, where \tilde{t}_j are chosen such that $f(t_j)$ and $f(\tilde{t}_j)$ are contained in the same link of C and such that $p^C(G_f)$ has no self intersections. Note that $p(V_j)$ is a vertical line which joins the endpoints of $p(H_{j-1})$ and $p(H_j)$ at $f(\tilde{t}_j)$. See Figure 5.1. Denote by $E(p^C(G_f))$ the endpoint of $p(H_0)$ corresponding to $(f(\tilde{t}_0), p(0))$.

Definition 5.5. If $p(J) = m$, we say that H_J is at the top of $p^C(G_f)$.

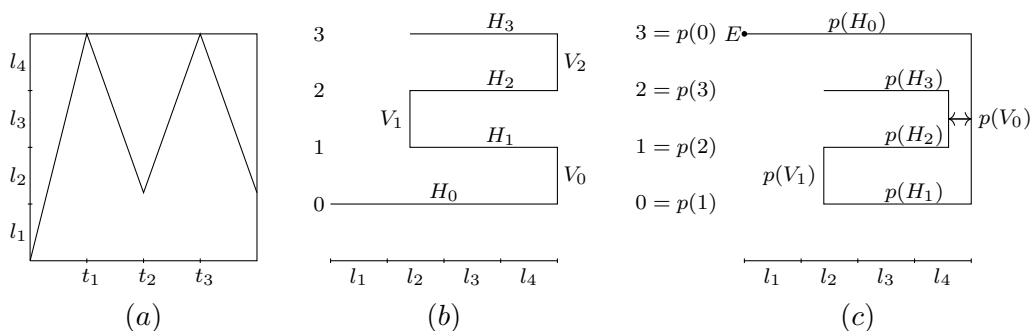

Figure 5.1: Flattened graph and its permutation. Note that H_0 is at the top of $p^C(G_f)$.

5.2 Chain refinements and stretching

We say that a planar chain $\mathcal{C} = \{\ell_1, \dots, \ell_n\}$ is *nice* if ℓ_i is an open disc in the plane for every $i \in \{1, \dots, n\}$ and if $\overline{\ell_i} \cap \overline{\ell_j} \neq \emptyset$ if and only if $|i - j| \leq 1$.

Definition 5.6. Let $\mathcal{C} = \{\ell_1, \dots, \ell_n\}$ be a planar chain. We say that an arc $A \subset \mathcal{C}^*$ is a *nerve* of \mathcal{C} if $A \cap \ell_i \neq \emptyset$ and $A \cap \ell_i$ is connected for every $i \in \{1, \dots, n\}$. Let $f : I \rightarrow I$ be a piecewise linear surjection, p an admissible \mathcal{C} -permutation of G_f and $\varepsilon > 0$. A nice planar chain $\mathcal{C} = \{\ell_1, \dots, \ell_n\}$ will be called a *tubular ε -chain with nerve $p^C(G_f)$* if

- $p^C(G_f)$ is a nerve of \mathcal{C}
- there exists $n \in \mathbb{N}$ and arcs $A_1 \cup \dots \cup A_n = p^C(G_f)$ such that ℓ_i is the ε -neighbourhood of A_i for every $i \in \mathbb{N}$.

Write $\mathcal{N}_{\mathcal{C}} = p^C(G_f)$.

Definition 5.7. A planar chain $\mathcal{C} = \{\ell_1, \dots, \ell_n\}$ will be called *horizontal* if there are $\delta > 0$ and a chain of open intervals $\{l_1, \dots, l_n\}$ in \mathbb{R} such that $\ell_i = l_i \times (-\delta, \delta)$ for every $i \in \{1, \dots, n\}$.

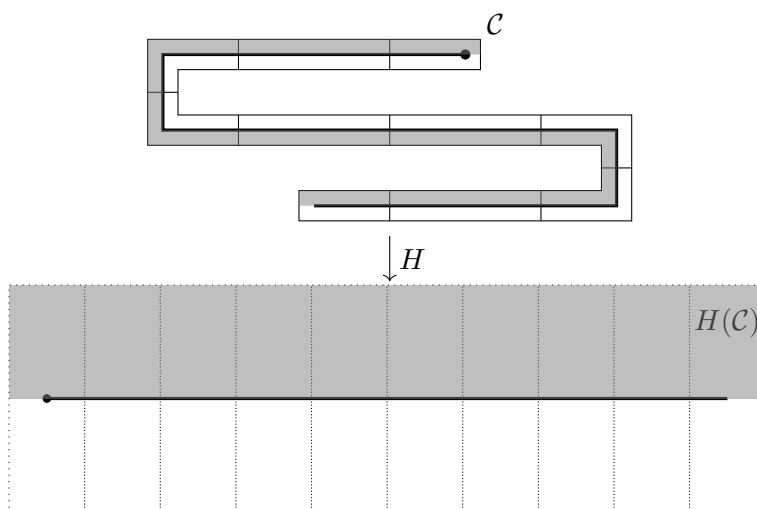

Figure 5.2: Stretching the chain \mathcal{C} .

Remark 5.8. Let \mathcal{C} be a tubular chain. There exists a homeomorphism $\widetilde{H} : \mathbb{R}^2 \rightarrow \mathbb{R}^2$ such that $\widetilde{H}(\mathcal{C})$ is a horizontal chain and $\widetilde{H}^{-1}(\mathcal{C}')$ is tubular for every tubular $\mathcal{C}' \prec \widetilde{H}(\mathcal{C})$. Moreover, denote $\mathcal{C} = \{\ell_1, \dots, \ell_n\}$, $\mathcal{N}_{\mathcal{C}} = p^{\mathcal{C}}(G_f)$ and $\mathcal{N}_{\widetilde{H}(\mathcal{C})} = I \times \{0\}$. Note that $\mathcal{C} \setminus (\ell_1 \cup \ell_n \cup \mathcal{N}_{\mathcal{C}})$ has two components and it makes sense to call them upper and lower. Denote by S the upper component of $\mathcal{C} \setminus (\ell_1 \cup \ell_n \cup \mathcal{N}_{\mathcal{C}})$.

There exists a homeomorphism $H : \mathbb{R}^2 \rightarrow \mathbb{R}^2$ which has all the properties of a homeomorphism \widetilde{H} above and in addition satisfies:

- $H(E(p^{\mathcal{C}}(G_f))) = (0, 0)$ (recall Definition 5.4) and
- $H(S)$ is the upper component of $H(\mathcal{C}^*) \setminus (H(\ell_1) \cup H(\ell_n) \cup H(A))$.

Applying H will be called stretching \mathcal{C} . See Figure 5.2.

Remark 5.9. Let $X, (C_n)_{n \in \mathbb{N}_0}, (C_n)_{n \in \mathbb{N}_0}$ be as constructed in Remark 2.21. Let \mathcal{D}_i be a horizontal chain with the same number of links as \mathcal{C}_i and such that $p^{\mathcal{C}_i}(G_{f_{i+1}}) \subset \mathcal{D}_i^*$ for some \mathcal{C}_i -admissible permutation p . Fix $\varepsilon' > 0$. There exists $0 < \varepsilon < \varepsilon'$ and an ε -tubular chain $\mathcal{D}_{i+1} \prec \mathcal{D}_i$ with the nerve $p^{\mathcal{C}_i}(G_{f_{i+1}})$ and such that $\text{Pat}(\mathcal{D}_{i+1}, \mathcal{D}_i) = \text{Pat}(\mathcal{C}_{i+1}, \mathcal{C}_i)$. However, the length of vertical segments of $p^{\mathcal{C}_i}(G_{f_{i+1}})$ might force $\text{mesh}(\mathcal{D}_{i+1}) \geq \varepsilon$. This problem can be

Chapter 5. Planar embeddings of chainable continua

easily resolved by adding more links to \mathcal{C}_{i+1} , i.e., refining the chain \mathcal{C}_{i+1} of I . To be more precise, if the longest vertical segment of $p^{C_i}(G_{f_{i+1}})$ has length N , then we want at least $\lfloor N\varepsilon + 1 \rfloor$ links of \mathcal{C}_{i+1} in the corresponding links of \mathcal{C}_i containing vertical segments. Then we arrange $> N\varepsilon$ rectangles of diameter $< \varepsilon$ along vertical segments in $\mathcal{D}_{i+1} \prec \mathcal{D}_i$. From now on we assume that natural chains are fine enough to achieve $\text{mesh}(\mathcal{D}_{i+1}) < \varepsilon$. See Figure 5.3.

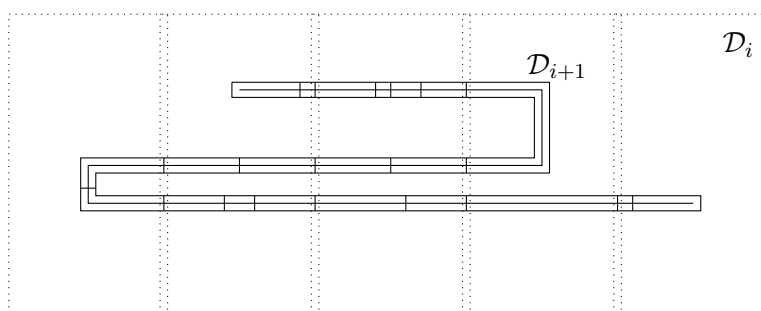

Figure 5.3: Constructing an ε -tubular chain with the nerve $p^C(G_f)$.

Remark 5.10. Vertical segments V_i in the flattened graph of f_n are obtained by “stretching” the graph at the critical values. Every critical point of f_n is contained in at most two links of \mathcal{C}_n . However, this does not imply that the corresponding vertical segment needs to be contained in at most two links of \mathcal{D}_n . We only need to carefully arrange links of \mathcal{D}_n inside \mathcal{D}_{n-1} such that $\text{Pat}(\mathcal{D}_n, \mathcal{D}_{n-1}) = \text{Pat}(\mathcal{C}_n, \mathcal{C}_{n-1})$, see Figure 5.4.

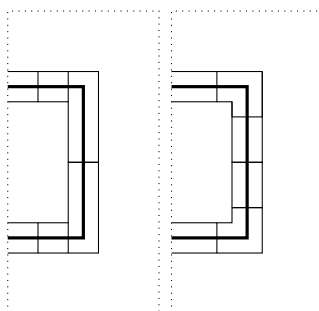

Figure 5.4: Arrangement of links of \mathcal{D}_n along the flattened graph of f_n is arbitrary, as long as we respect the $\text{Pat}(\mathcal{D}_n, \mathcal{D}_{n-1}) = \text{Pat}(\mathcal{C}_n, \mathcal{C}_{n-1})$.

Definition 5.11. Let $H : \mathbb{R}^2 \rightarrow \mathbb{R}^2$ be the stretching of some tubular chain \mathcal{C} . If \mathcal{C}' is a nice chain in \mathbb{R}^2 refining \mathcal{C} and there is an interval map $g : I \rightarrow I$ such that $p^{\mathcal{C}}(G_g)$ is the nerve of $H(\mathcal{C}')$, then we say that \mathcal{C}' follows $p^{\mathcal{C}}(G_g)$ in \mathcal{C} .

5.3 Composing chain refinements

Let $f, g : I \rightarrow I$ be piecewise linear surjections. Denote by $0 = t_0 < t_1 < \dots < t_m < t_{m+1} = 1$ the critical points of f and by $0 = s_0 < s_1 < \dots < s_n < s_{n+1} = 1$ the critical points of g . Let C_1 and C_2 be nice chains of I , $p_1 : \{0, 1, \dots, m\} \rightarrow \{0, 1, \dots, m\}$ an admissible C_1 -permutation of G_f and $p_2 : \{0, 1, \dots, n\} \rightarrow \{0, 1, \dots, n\}$ an admissible C_2 -permutation of G_g .

Assume $\mathcal{C}'' \prec \mathcal{C}' \prec \mathcal{C}$ are nice chains in \mathbb{R}^2 such that \mathcal{C} is horizontal and $p_1^{C_1}(G_f) \subset \mathcal{C}^*$ (recall that \mathcal{C}^* denotes the union of links of \mathcal{C}), \mathcal{C}' is a tubular chain with $\mathcal{N}_{\mathcal{C}'} = p_1^{C_1}(G_f)$, and \mathcal{C}'' follows $p_2^{C_2}(G_g)$ in \mathcal{C}' . Then \mathcal{C}'' follows $f \circ g$ in \mathcal{C} with respect to a C_1 -admissible permutation of $G_{f \circ g}$ which we will denote by $p_1 * p_2$. See Figure 5.5 and Figure 5.6.

Define

$$A_{ij} = \{x \in I : x \in [s_i, s_{i+1}], g(x) \in [t_j, t_{j+1}]\},$$

for $i \in \{0, 1, \dots, n\}, j \in \{0, 1, \dots, m\}$, i.e., A_{ij} are maximal intervals on which $f \circ g$ is injective and possibly $A_{ij} = \emptyset$. Denote by H_{ij} the horizontal branches of $G_{f \circ g}$ corresponding to the intervals A_{ij} .

We want to see which H_{ij} corresponds to the top of $(p_1 * p_2)^{C_1}(G_{f \circ g})$. Denote by $p_1(H_{T_1})$ the top of $p_1^{C_1}(G_f)$, i.e., $p_1(T_1) = m$. Denote by $p_2(H_{T_2})$ the top of $p_2^{C_2}(G_g)$, i.e., $p_2(T_2) = n$. By the choice of orientation of H , the top of $(p_2 * p_1)^{C_1}(G_{f \circ g})$ is $H_{T_2 T_1}$. See Figures 5.5 and 5.6.

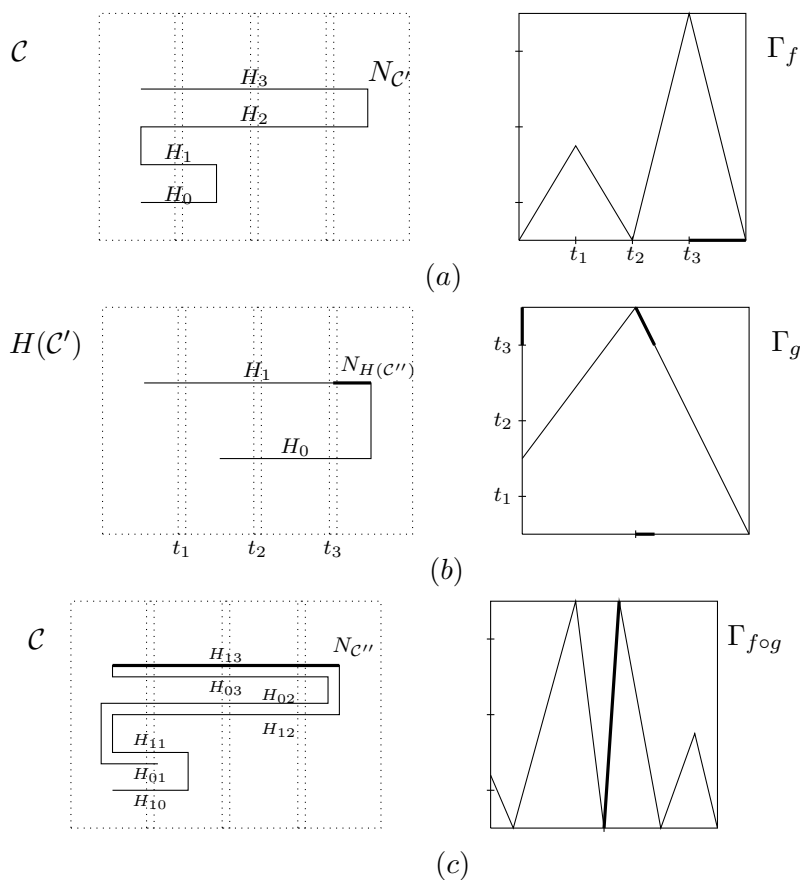

Figure 5.5: Composing refinements. In (a) the horizontal chain \mathcal{C} and the nerve of \mathcal{C}' are drawn. The nerve $N_{\mathcal{C}'}$ equals $G_f^{C_1}$, a flattened version of the graph Γ_f . In (b) we draw \mathcal{C}' as a horizontal chain by applying H . Also, the nerve $N_{H(\mathcal{C}'')}$ is given as $G_g^{C_2}$ a flattened version of the graph Γ_g . In (c) we draw $N_{\mathcal{C}''}$ in \mathcal{C} . In bold we trace the arc which is the top of $(id * id)^{C_1}(G_{f \circ g}) = N_{\mathcal{C}''}$.

5.4 Construction of the embeddings

Let $X = \varprojlim \{I, f_i\}$ where for every $i \in \mathbb{N}$ the map f_i is a continuous surjection which is piecewise linear with finitely many critical points $0 = t_0^i < t_1^i < \dots < t_{m(i)}^i < t_{m(i)+1}^i = 1$. Denote by $I_k^i = [t_k^i, t_{k+1}^i]$ for every $i \in \mathbb{N}$ and every $k \in \{0, \dots, m(i)\}$. We construct chains $(C_n)_{n \in \mathbb{N}_0}$ and $(\mathcal{C}_n)_{n \in \mathbb{N}_0}$ as before, such that $f_{i+1}(I_k^{i+1})$ is not contained in the same link of C_i for all $k \in \{0, \dots, m(i+1)\}$ and all $i \in \mathbb{N}_0$. The flattened graph of f_i will be denoted by $G_{f_i} = H_0^i \cup V_1^i \cup \dots \cup V_{m(i)}^i \cup H_{m(i)}^i$ for all $i \in \mathbb{N}_0$.

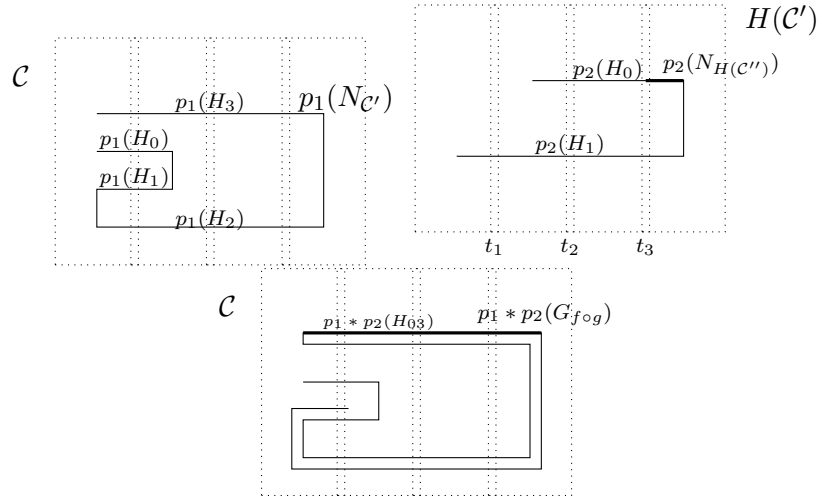

Figure 5.6: Composing permuted refinements. Here $p_1 = (0 \ 2)$ and $p_2 = (0 \ 1)$ are admissible. The top of $p_1(N_{\mathcal{C}'})$ is $p_1(H_3)$, so $T_1 = 3$. The top of $p_2(N_{H(\mathcal{C}'')})$ is $p_2(H_0)$, so $T_2 = 0$. Thus, the top of $(p_1 * p_2)^{C_1}(G_{f \circ g})$ is $H_{T_2 T_1} = H_{03}$ (in bold).

Theorem 5.12. *Assume $x = (\dots, x_2, x_1, x_0) \in X$ is such that $x_i \in I_{k(i)}^i$ for all $i \in \mathbb{N}_0$ and assume that for every $i \in \mathbb{N}$ there exists an admissible permutation (with respect to C_{i-1}) $p_i : \{0, \dots, m(i)\} \rightarrow \{0, \dots, m(i)\}$ of G_{f_i} such that $p_i(k(i)) = m(i)$. Then there exists a planar embedding of X such that x is accessible.*

Proof. Fix a strictly decreasing sequence $(\varepsilon_i)_{i \in \mathbb{N}}$ such that $\varepsilon_i \rightarrow 0$ as $i \rightarrow \infty$. Let \mathcal{D}_0 be a nice horizontal chain in \mathbb{R}^2 with the same number of links as \mathcal{C}_0 . By Remark 5.9 we can find an ε_1 -tubular chain $\mathcal{D}_1 \prec \mathcal{D}_0$ with the nerve $p_1^{C_0}(G_{f_1})$, such that $Pat(\mathcal{D}_1, \mathcal{D}_0) = Pat(\mathcal{C}_1, \mathcal{C}_0)$ and $mesh(\mathcal{D}_1) < \varepsilon_1$. Note that $p_1(k(1)) = m(1)$.

Let $F : \mathbb{R}^2 \rightarrow \mathbb{R}^2$ be the stretching of \mathcal{D}_1 (see Remark 5.8). Define $F(\mathcal{D}_2) \prec F(\mathcal{D}_1)$ such that $mesh(\mathcal{D}_2) < \varepsilon_2$ (this can be done since F is uniformly continuous), $Pat(F(\mathcal{D}_2), F(\mathcal{D}_1)) = Pat(\mathcal{C}_2, \mathcal{C}_1)$ and the nerve of $F(\mathcal{D}_2)$ is $p_2^{C_1}(G_{f_2})$. Thus $H_{k(2)}^2$ is the top of $N_{F(\mathcal{D}_2)}$. By the arguments in the previous section, the top of $N_{\mathcal{D}_2}$ is $H_{k(2)k(1)}$.

As in the previous section, denote the maximal intervals of monotonicity of

$f_1 \circ \dots \circ f_i$ by

$$A_{n(i)\dots n(1)} := \{x \in I : x \in I_{n(i)}^i, f_i(x) \in I_{n(i-1)}^{i-1}, \dots, f_1 \circ \dots \circ f_{i-1}(x) \in I_{n(1)}^1\},$$

and denote the corresponding horizontal intervals of $G_{f_1 \circ \dots \circ f_i}$ by $H_{n(i)\dots n(1)}$.

Assume we have constructed $\mathcal{D}_i \prec \mathcal{D}_{i-1} \prec \dots \prec \mathcal{D}_1 \prec \mathcal{D}_0$. Take the stretching $F : \mathbb{R}^2 \rightarrow \mathbb{R}^2$ of \mathcal{D}_i and define $F(\mathcal{D}_{i+1}) \prec F(\mathcal{D}_i)$ such that $\text{mesh}(\mathcal{D}_{i+1}) < \varepsilon_{i+1}$, $\text{Pat}(F(\mathcal{D}_{i+1}), F(\mathcal{D}_i)) = \text{Pat}(\mathcal{C}_{i+1}, \mathcal{C}_i)$ and such that the nerve of $F(\mathcal{D}_{i+1})$ is $p_{i+1}^{\mathcal{C}_i}(G_{f_{i+1}})$. Note that the top of $\mathcal{N}_{\mathcal{D}_{i+1}}$ is $H_{k(i+1)\dots k(1)}$.

Since $\text{Pat}(F(\mathcal{D}_{i+1}), F(\mathcal{D}_i)) = \text{Pat}(\mathcal{D}_{i+1}, \mathcal{D}_i)$ for every $i \in \mathbb{N}_0$ and by the choice of (ε_i) , Lemma 2.11 yields that $\bigcap_{n \in \mathbb{N}_0} \mathcal{D}_n^*$ is homeomorphic to X . Denote by $\varphi(X) := \bigcap_{n \in \mathbb{N}_0} \mathcal{D}_n^*$.

To see that x is accessible, note that $\lim_{i \rightarrow \infty} H_{k(i)\dots k(1)}$ is a well defined horizontal arc in $\varphi(X)$ (possibly degenerate). Denote that arc by $H = [a, b] \times \{h\}$ for some $h \in \mathbb{R}$. Note that for every $y = (y_1, y_2) \in \varphi(X)$ it holds that $y_2 \leq h$. Thus every point in $p = (p_1, h) \in H$ is accessible by the vertical planar arc $\{p_1\} \times [h, h+1]$. Since $x \in H$, the construction is complete. \square

5.5 Zig-zags

Definition 5.13. *Let $f : I \rightarrow I$ be a continuous piecewise linear surjection with finitely many critical points $0 = t_0 < t_1 < \dots < t_m < t_{m+1} = 1$. Denote by $I_k = [t_k, t_{k+1}]$ for every $k \in \{0, \dots, m\}$. We say that I_k is in a zigzag of f if there exist critical points a and e of f such that $a < t_k < t_{k+1} < e \in I$ and either*

1. $f(t_k) > f(t_{k+1})$, a is the (strict) minimum and e is the (strict) maximum of $f|_{[a,e]}$, or
2. $f(t_k) < f(t_{k+1})$, a is the (strict) maximum and e is the (strict) minimum of $f|_{[a,e]}$.

Chapter 5. Planar embeddings of chainable continua

We also say that $x \in I_k$ is contained in a zigzag of f and that f contains a zigzag. See Figure 5.7.

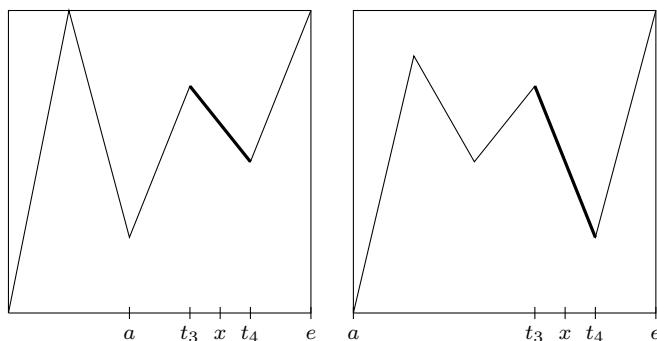

Figure 5.7: Zigzag.

Lemma 5.14. *Let $f : I \rightarrow I$ be a continuous piecewise linear surjection with finitely many critical points $0 = t_0 < t_1 < \dots < t_m < t_{m+1} = 1$. If $I_k = [t_k, t_{k+1}]$ is not in a zigzag of f for some $k \in \{0, \dots, m\}$, then there exists an admissible permutation p of G_f (with respect to any nice chain C) such that $p(k) = m$.*

Proof. Assume I_k is not in a zigzag of f . Assume without loss of generality that $f(t_k) > f(t_{k+1})$. If $f(a) \geq f(t_{k+1})$ for all $a \in [0, t_k]$ (or if $f(e) \leq f(t_k)$ for all $e \in [t_{k+1}, 1]$) we are done, simply reflect all H_i , $i < k$ over H_k (or reflect all H_i , $i > k$ over H_k in the second case). See Figure 5.8.

Therefore, assume that there exists $a \in [0, t_k]$ such that $f(a) < f(t_{k+1})$ and there exists $e \in [t_{k+1}, 1]$ such that $f(e) > f(t_k)$. Denote the largest such a by a_1 and the smallest such e by e_1 . Since I_k is not in a zigzag, there exists $e' \in [t_{k+1}, e_1]$ such that $f(e') \leq f(a_1)$ or there exists $a' \in [a_1, t_k]$ such that $f(a') \geq f(e_1)$. Assume the first case and take e' such that it is a minimum of $f|_{[t_{k+1}, e_1]}$ (in the second case we take a' such that it is a maximum of $f|_{[a_1, t_k]}$). Reflect $f|_{[a_1, t_k]}$ over $f|_{[t_k, e']}$ (in the second case we reflect $f|_{[t_{k+1}, e_1]}$ over $f|_{[a', t_{k+1}]}$). Then, H_k becomes the top of $G_{f|_{[a_1, e_1]}}$. See Figure 5.9.

If $f(a) \geq f(e')$ for all $a \in [0, a_1]$ (or if $f(e) \leq f(a')$ for all $e \in [e_1, 1]$ in the second case), we are done. So assume there is $a_2 \in [0, a_1]$ such that

Chapter 5. Planar embeddings of chainable continua

$f(a_2) < f(e')$ and take the largest such a_2 . Then there exists $a'' \in [a_2, a_1]$ such that $f(a'') \geq f(e_1)$, take a'' to be a maximum of $f|_{[a_2, a_1]}$. If $f(e) \leq f(a'')$ for all $e \in [e_1, 1]$, we reflect $f|_{[a_2, a'']}$ over $f|_{[e_1, 1]}$ and are done. If there is (minimal) $e_2 > e_1$ such that $f(e_2) > f(a'')$, then there exists $e'' \in [e_1, e_2]$ such that $f(e'') \leq f(a_2)$ and e'' is a minimum of $f|_{[e_1, e_2]}$. In that case we reflect $f|_{[a'', t_k]}$ over $f|_{[t_k, e']}$ and $f|_{[a_2, a'']}$ over $f|_{[t_k, e'']}$, see Figure 5.10. Thus we have constructed a permutation such that H_k becomes the top of $G_{f|_{[a_2, e_2]}}$. Proceed inductively. \square

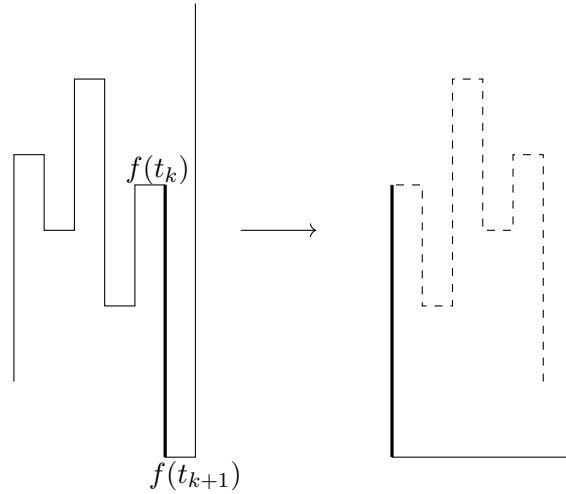

Figure 5.8: Reflections in the proof of Lemma 5.14.

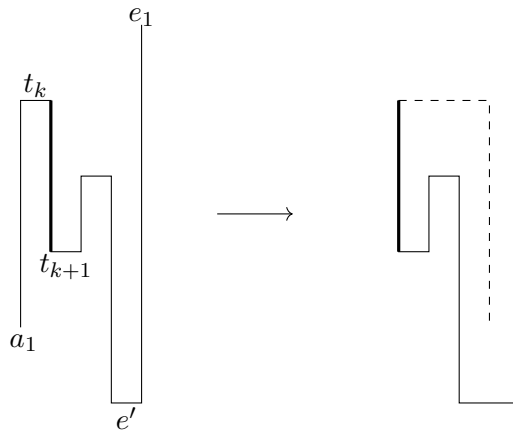

Figure 5.9: Reflections in the proof of Lemma 5.14.

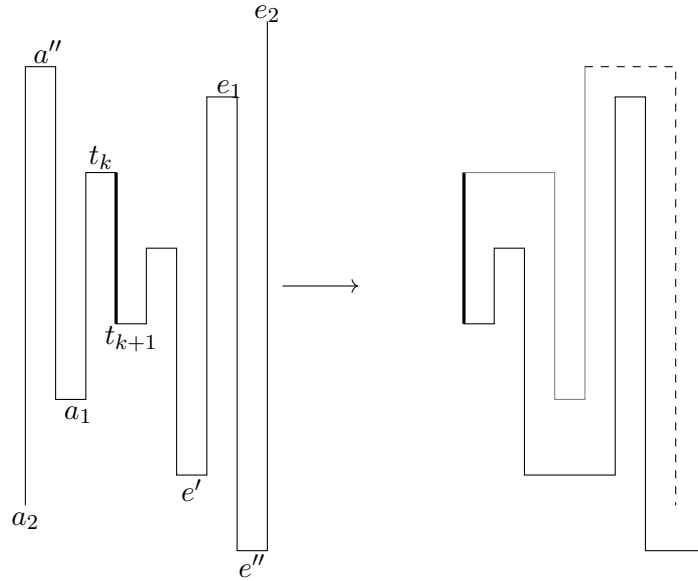

Figure 5.10: Reflections in the proof of Lemma 5.14.

Recall the main theorem of this chapter, Theorem 1.7:

Let $X = \varprojlim \{I, f_i\}$, where $f_i : I \rightarrow I$ are continuous piecewise linear surjections with finitely many critical points. If $x = (\dots, x_2, x_1, x_0) \in X$ is such that x_i is not in a zigzag of f_i for all $i \in \mathbb{N}$, then there exists an embedding of X in the plane such that x is accessible.

Proof of Theorem 1.7. The proof follows easily by Lemma 5.14 and Theorem 5.12. \square

Corollary 5.15. Let $X = \varprojlim \{I, f_i\}$ where $f_i : I \rightarrow I$ are continuous piecewise linear surjections with finitely many critical points and which do not have zigzags for all $i \in \mathbb{N}$. Then for every $x \in X$ there exists an embedding of X in the plane such that x is accessible.

Remark 5.16. Note that if T is unimodal interval map and $x \in \varprojlim ([0, 1], T_s)$, then $\varprojlim ([0, 1], T_s)$ can be embedded in the plane such that x is accessible by the previous corollary. That is Theorem 1 of [5]. This easily generalizes to an inverse limit of open interval maps (e.g. generalized Knaster continua).

The following lemma shows that, given arbitrary chains (C_i) , the zigzag condition from Lemma 5.14 cannot be improved.

Chapter 5. Planar embeddings of chainable continua

Lemma 5.17. *Let $f : I \rightarrow I$ be a continuous piecewise linear surjection with finitely many critical points $0 = t_0 < t_1 < \dots < t_m < t_{m+1} = 1$. If $I_k = [t_k, t_{k+1}]$ is in a zigzag for some $k \in \{0, \dots, m\}$, then there exists a nice chain C of I such that $p(k) \neq m$ for every admissible permutation p of G_f with respect to C .*

Proof. Take a nice chain C of I such that $\text{mesh } C < \min\{|f(t_i) - f(t_j)| : i, j \in \{0, \dots, m+1\}, f(t_i) \neq f(t_j)\}$. Assume without loss of generality that $f(t_k) > f(t_{k+1})$ and let $t_i < t_k < t_{k+1} < t_j$ be such that t_j is a maximum and t_i is a minimum of $f|_{[t_i, t_j]}$. Assume t_i is the largest and t_j is the smallest with such properties. Let p be some permutation. If $p(i) < p(j) < p(k)$, then by the choice of C , $p(H_j)$ intersects $p(V_{i'})$ for some $i' \in \{i, \dots, k\}$. We proceed similarly if $p(j) < p(i) < p(k)$. \square

Remark 5.18. *For the contrast to the previous theorem, we note that for every point of the pseudo-arc there are infinitely many projections contained in zigzags of bonding maps. However, since the pseudo-arc is homogeneous, every point can be embedded accessible.*

Remark 5.19. *Let $X = \varprojlim\{I, f_i\}$ and $x = (\dots, x_2, x_1, x_0) \in X$. If there exist piecewise linear continuous surjections $g_i : I \rightarrow I$ and a homeomorphism $h : X \rightarrow \varprojlim\{I, g_i\}$ such that for every i , $\pi_i(h(x))$ is not in zigzag of g_i , then X can be embedded in the plane such that x is accessible. We specifically have the following two corollaries. See also Examples 5.22-5.24.*

Corollary 5.20. *Let $X = \varprojlim\{I, f_i\}$ where $f_i : I \rightarrow I$ are continuous piecewise linear surjections with finitely many critical points. If $x = (\dots, x_2, x_1, x_0) \in X$ is such that x_i is not in a zigzag of f_i for all but finitely many $i \in \mathbb{N}$, then there exists an embedding of X in the plane such that x is accessible.*

Proof. Since $\varprojlim\{I, f_i\}$ and $\varprojlim\{I, f_{i+n}\}$ are homeomorphic for every $n \in \mathbb{N}$, the proof follows using Theorem 1.7. \square

Corollary 5.21. *Let f be a continuous piecewise linear surjection with finitely many critical points and $x = (\dots, x_2, x_1, x_0) \in X = \varprojlim\{I, f\}$. If there exists $k \in \mathbb{N}$ such that x_i is not in a zigzag of f^k for all (but finitely many) i , then there exists a planar embedding of X such that x is accessible.*

Chapter 5. Planar embeddings of chainable continua

Proof. Note that $\varprojlim\{I, f^k\}$ and X are homeomorphic. □

Example 5.22. Let f be a piecewise linear map such that $f(0) = 0$, $f(1) = 1$ and with critical points $\frac{1}{4}, \frac{3}{4}$, where $f(\frac{1}{4}) = \frac{3}{4}$ and $f(\frac{3}{4}) = \frac{1}{4}$, see Figure 5.11.

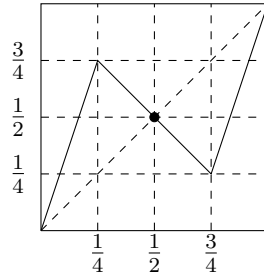

Figure 5.11: Graph of f from Example 5.22.

Note that $X = \varprojlim\{I, f\}$ are two rays compactifying on an arc and therefore, for every $x \in X$, there exists a planar embedding making x accessible. However, the point $\frac{1}{2}$ is in a zigzag of f . In Figure 5.12 we draw the graph of f^2 . Note that $\frac{1}{2}$ is not contained in a zigzag of f^2 and that gives an embedding of X such that $(\dots, \frac{1}{2}, \frac{1}{2})$ is accessible.

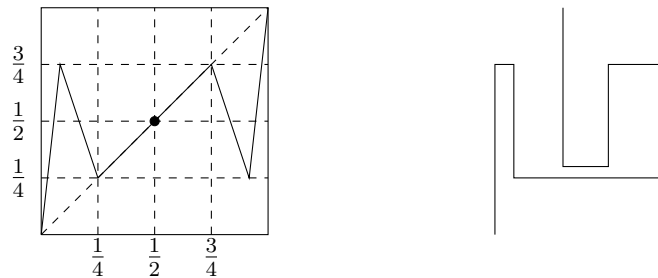

Figure 5.12: Graph of f^2 from Example 5.22.

Let $x = (\dots, x_2, x_1, x_0) \in X$ be such that $x_i \in [1/4, 3/4]$ for all but finitely many $i \in \mathbb{N}_0$. Then the embedding in Figure 5.12 will make x accessible. For other points $x = (\dots, x_2, x_1, x_0) \in X$ there exists $N \in \mathbb{N}$ such that $x_i \in [0, 1/4]$ for all $i > N$ or $x_i \in [3/4, 1]$ for all $i > N$ so the standard embedding makes them accessible. In fact, the embedding from Figure 5.12 will make every $x \in X$ accessible.

Chapter 5. Planar embeddings of chainable continua

Example 5.23. Assume that f is a piecewise linear map with $f(0) = 0$, $f(1) = 1$ and critical points $f(\frac{3}{8}) = \frac{3}{4}$ and $f(\frac{5}{8}) = \frac{1}{4}$ (see Figure 5.13).

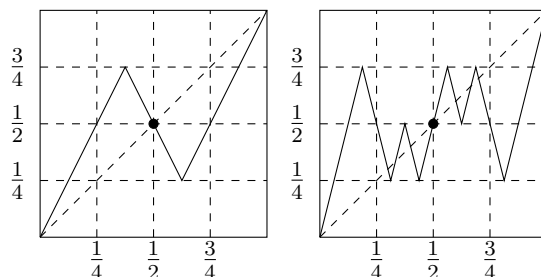

Figure 5.13: Graph of f and f^2 in Example 5.23.

Note that $X = \varprojlim\{I, f\}$ consists of two Knaster continua joined at their endpoints together with two rays both converging to these two Knaster continua. Note that $(\dots, \frac{1}{2}, \frac{1}{2})$ can be embedded accessible with the use of f^2 , see Figure 5.13. However, as opposed to the previous example, this continuum cannot be embedded such that every point is accessible. In [73] it is proven that such an embedding of a chainable continuum exists if and only if it is *Suslinean*, *i.e.*, contains at most countably many mutually disjoint non-degenerate subcontinua.

Example 5.24 (Nadler). Let $f : I \rightarrow I$ be as in Figure 5.14. This is Nadler's candidate for a counterexample from [78]. However, we show that every point can be embedded accessible.

Let $n \in \mathbb{N}$. If $J \subset I$ is a maximal interval such that $f^n|_J$ is increasing, then J is not contained in a zigzag of f^n , see *e.g.* Figure 5.14.

We will code the orbit of points in the invariant interval $[1/5, 4/5]$ in the following way. For $y \in [1/5, 4/5]$ let $i(y) = (y_n)_{n \in \mathbb{N}_0} \subset \{0, 1, 2\}^\infty$, where

$$y_n = \begin{cases} 0, & f^n(y) \in [1/5, 2/5], \\ 1, & f^n(y) \in [2/5, 3/5], \\ 2, & f^n(y) \in [3/5, 4/5]. \end{cases}$$

Chapter 5. Planar embeddings of chainable continua

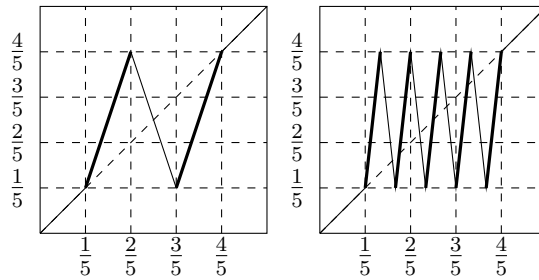

Figure 5.14: Map f and its second iterate. Bold lines are increasing branches of the restriction to $[1/5, 4/5]$. Note that they are not contained in a zigzag of f and f^2 respectively.

The definition is somewhat ambiguous, the problem occurring at points $2/5$ and $3/5$. Note, however, that $f^n(2/5) = 4/5$ and $f^n(3/5) = 1/5$ for all $n \in \mathbb{N}$. So every point in $[1/5, 4/5]$ will have a unique itinerary, except the preimages of $2/5$ (to which we can assign two itineraries $a_1 \dots a_n \overset{0}{1} 2222 \dots$) and preimages of $3/5$, (to which we can assign two itineraries $a_1 \dots a_n \overset{1}{2} 0000 \dots$), where $\overset{0}{1}$ means “0 or 1” and $a_1, \dots, a_n \in \{0, 1, 2\}$.

Note that if $i(y) = 1y_2 \dots y_n 1$, where $y_i \in \{0, 2\}$ for every $i \in \{2, \dots, n\}$, then y is contained in an increasing branch of f^{n+1} . This hold also if $n = 1$, *i.e.*, $y_2 \dots y_n = \emptyset$. Also, if $i(y) = 0 \dots$ or $i(y) = 2 \dots$, then y is contained in an increasing branch of f . See Figure 5.15.

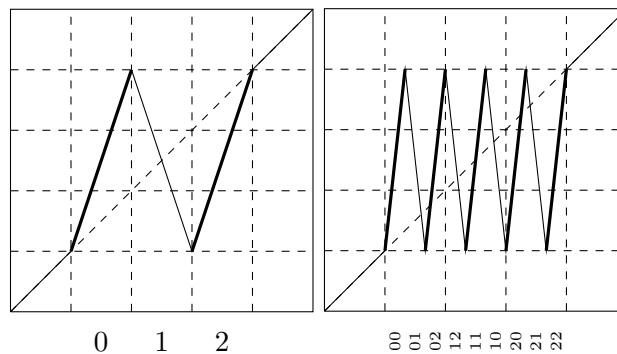

Figure 5.15: Map f and its iterate with symbolic coding of points. Note that points with itinerary $0 \dots$ or $2 \dots$ are contained in an increasing branch of f and points with itineraries $11 \dots$ are contained in an increasing branch of f^2 .

We extend symbolic coding to X . Let $x = (\dots, x_2, x_1, x_0) \in X$ and denote

Chapter 5. Planar embeddings of chainable continua

by $I(x) = (y_i)_{i \in \mathbb{Z}}$, where $(y_i)_{i \in \mathbb{N}_0} = i(x_0)$ and

$$y_i = \begin{cases} 0, & x_{-i} \in [1/5, 2/5], \\ 1, & x_{-i} \in [2/5, 3/5], \\ 2, & x_{-i} \in [3/5, 4/5], \end{cases}$$

for every $i \leq 0$. Again, the assignment is injective except at preimages of critical points $2/5$ or $3/5$.

Now fix $x = (\dots, x_2, x_1, x_0) \in X$ with its backward itinerary $\overleftarrow{x} = \dots y_{-2}y_{-1}y_0$ (assume the itinerary is unique, otherwise choose one of the two possible backward itineraries). Assume first that $y_k \in \{0, 2\}$ for every $k \leq 0$. Then for every $k \in \mathbb{N}_0$ it holds that $i(x_k) = 0\dots$ or $i(x_k) = 2\dots$ so x_k is in an increasing branch of f and thus not contained in a zigzag of f . By Theorem 1.7 it follows that there is an embedding making x accessible. Similarly, if there exists $n \in \mathbb{N}$ such that $y_k \neq 1$ for $k < -n$, then use $X \simeq \varprojlim \{I, f_j\}$ where $f_1 = f^n$, $f_j = f$ for $j \geq 2$.

Assume that $\overleftarrow{x} = \dots 1(\frac{0}{2})^{n_3}1(\frac{0}{2})^{n_2}1(\frac{0}{2})^{n_1}$ where $\frac{0}{2}$ means “0 or 2” and $n_i \geq 0$ for $i \in \mathbb{N}$. We will assume that $n_1 > 0$; the general case follows similarly. Note that $i(x_{n_1-1}) = (\frac{0}{2})^{n_1} \dots$ and so it is contained in an increasing branch of f^{n_1-1} . Note further that $i(x_{n_1+1+n_2}) = 1(\frac{0}{2})^{n_2}1(\frac{0}{2})^{n_1} \dots$ and so it is contained in an increasing branch of f^{n_2+2} . Also $f^{n_2+2}(x_{n_1+1+n_2}) = x_{n_1-1}$. Further we note that $i(x_{n_1+1+n_2+1+n_3-1}) = (\frac{0}{2})^{n_3}1(\frac{0}{2})^{n_2}1(\frac{0}{2})^{n_1}$ and so it is contained in an increasing branch of f^{n_3} . Furthermore, $f^{n_3}(x_{n_1+1+n_2+1+n_3-1}) = x_{n_1+1+n_2}$.

Continuing further, we see that for every even $k \geq 4$ it holds that

$$i(x_{n_1+1+n_2+1+\dots+1+n_k}) = 1 \left(\frac{0}{2}\right)^{n_k} 1 \dots 1 \left(\frac{0}{2}\right)^{n_1} \dots$$

and so it is contained in an increasing branch of f^{n_k+2} . Also note that $f^{n_k+2}(x_{n_1+1+n_2+1+\dots+1+n_k}) = x_{n_1+1+n_2+1+\dots+1+n_{k-1}-1}$. Similarly,

$$i(x_{n_1+1+n_2+1+\dots+1+n_k+1+n_{k+1}-1}) = \left(\frac{0}{2}\right)^{n_{k+1}} 1 \dots 1 \left(\frac{0}{2}\right)^{n_1} \dots$$

so $x_{n_1+1+n_2+1+\dots+1+n_k+1+n_{k+1}-1}$ is in an increasing branch of $f^{n_{k+1}}$. Note also that $f^{n_{k+1}}(x_{n_1+1+n_2+1+\dots+1+n_k+1+n_{k+1}-1}) = x_{n_1+1+n_2+1+\dots+1+n_k}$.

So we have the following

$$\dots \xrightarrow{f^{n_5}} x_{n_1+1+\dots+1+n_4} \xrightarrow{f^{n_4+2}} x_{n_1+1+n_2+1+n_3-1} \xrightarrow{f^{n_3}} x_{n_1+1+n_2} \xrightarrow{f^{n_2+2}} x_{n_1-1} \xrightarrow{f^{n_1-1}} x_0,$$

where the chosen points in the sequence are not contained in zigzags of the corresponding bonding maps. Let

$$f_i = \begin{cases} f^{n_1-1}, & i = 1, \\ f^{n_i+2}, & i \text{ even}, \\ f^{n_i}, & i > 1 \text{ odd}. \end{cases}$$

Then $\varprojlim \{I, f_i\} \simeq X$ and by Theorem 1.7 it can be embedded in the plane such that x is accessible.

5.6 Thin embeddings

We proved that if a chainable continuum X has an inverse limit representation such that $x \in X$ is not contained in zigzags of bonding maps, then there is a planar embedding of X making x accessible. Note that the converse is not true. The obvious example is the pseudo-arc which is homogeneous thus its every point can be embedded accessible. However, the crookedness of the pseudo-arc implies the occurrence of zigzags in every representation. It is well-known that the pseudo-arc can be obtained as the inverse limit of the Henderson map from [50], but note that the zigzags in the Henderson map get smaller and in the limit no point is contained in an arc. That will not happen for *e.g.* Minc's continuum X_M , see Figure 5.16. There, every point is contained in an arc of length at least $\frac{1}{3}$.

Question 5.25. *Is there an embedding of X_M which makes p accessible? Is there a thin embedding (see Definition 5.27) of X_M which makes p accessible?*

In the next definition we introduce the notion of *thin embedding*, used under

Chapter 5. Planar embeddings of chainable continua

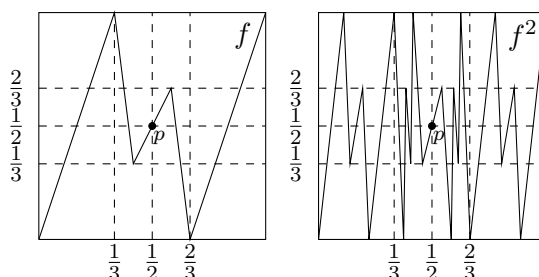

Figure 5.16: Minc's map and its second iteration.

this name in *e.g.* [43]. In [4] the notion of thin embedding was referred to as *C-embedding*.

Definition 5.26. Let $Y \subset \mathbb{R}^2$ be a continuum. We say that Y is thin chainable if there exists a sequence $(\mathcal{C}_n)_{n \in \mathbb{N}}$ of chains in \mathbb{R}^2 such that $Y = \bigcap_{n \in \mathbb{N}} \mathcal{C}_n$, where $\mathcal{C}_{n+1} \prec \mathcal{C}_n$ for every $n \in \mathbb{N}$, $\text{mesh}(\mathcal{C}_n) \rightarrow 0$ as $n \rightarrow \infty$ and the links of \mathcal{C}_n are connected sets in \mathbb{R}^2 (note that links are open in the topology of \mathbb{R}^2).

Definition 5.27. Let X be a chainable continuum. We say that an embedding $\varphi : X \rightarrow \mathbb{R}^2$ is a thin embedding if $\varphi(X)$ is thin chainable. Otherwise φ is called a thick embedding.

Example 5.28 (Bing). An example of a thick embedding of an Elsa continuum was constructed by Bing in [22], see Figure 5.17.

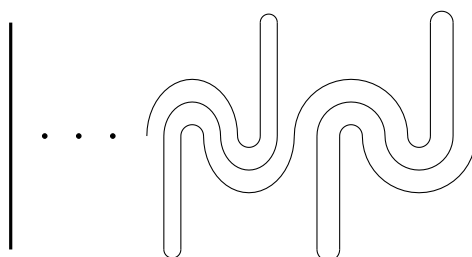

Figure 5.17: Bing's example from [22].

An example of a thick embedding of 3-Knaster continuum was given by Dębski and Tymchatyn in [43]. An arc has a unique planar embedding (up to equivalence), so its every planar embedding is a thin embedding.

Chapter 5. Planar embeddings of chainable continua

Question 5.29 (Question 1 in [4]). *Which chainable continua have a thick embedding in the plane?*

Definition 5.30. *Let X be chainable. By $\mathcal{E}_C(X)$ we denote the set of all planar embeddings of X obtained by performing admissible permutations of G_{f_i} for every representation $X = \varprojlim\{I, f_i\}$.*

Theorem 5.31. *Let X be a chainable continuum and $\varphi : X \rightarrow \mathbb{R}^2$ a thin embedding of X . Then there exists an embedding $\psi \in \mathcal{E}_C(X)$ equivalent to ψ .*

Proof. Denote by $\varphi(X) = \bigcap_{n \in \mathbb{N}_0} \mathcal{C}_n$, where the links of \mathcal{C}_n are open, connected sets in \mathbb{R}^2 and $\mathcal{C}_{n+1} \prec \mathcal{C}_n$ for every $n \in \mathbb{N}_0$. Without loss of generality we can assume that links of \mathcal{C}_n are simply connected with a polygonal curve for a boundary. Moreover, we can assume that the intersection of every two links is simply connected. The existence of the homeomorphisms constructed in the proof follows from the generalization of the piecewise linear Schoenflies' theorem given in *e.g.* [75, Section 3]. Take a homeomorphism $F_0 : \mathbb{R}^2 \rightarrow \mathbb{R}^2$ which maps \mathcal{C}_0 to a horizontal chain. Then $F_0(\mathcal{C}_1) \prec F_0(\mathcal{C}_0)$ and there is a homeomorphism $F_1 : \mathbb{R}^2 \rightarrow \mathbb{R}^2$ which is identity on $\mathbb{R}^2 \setminus F_0(\mathcal{C}_0)^*$ (recall that \mathcal{C}^* denotes the union of links of \mathcal{C}), and which maps $F_0(\mathcal{C}_1)$ to a tubular neighbourhood of some permuted flattened graph with $\text{mesh}(F_1(F_0(\mathcal{C}_1))) < \text{mesh}(\mathcal{C}_1)$.

For $n \geq 1$ denote by $G_n := F_n \circ \dots \circ F_1 \circ F_0$ and note that $G_n(\mathcal{C}_{n+1}) \prec G_n(\mathcal{C}_n)$ and there is a homeomorphism $F_{n+1} : \mathbb{R}^2 \rightarrow \mathbb{R}^2$ which is identity on $\mathbb{R}^2 \setminus G_n(\mathcal{C}_n)^*$ and which maps $G_n(\mathcal{C}_{n+1})$ to a tubular neighbourhood of some flattened permuted graph with $\text{mesh}(F_{n+1}(G_n(\mathcal{C}_{n+1}))) < \text{mesh}(\mathcal{C}_{n+1})$.

Note that the sequence $(G_n)_{n \in \mathbb{N}_0}$ is uniformly Cauchy and denote by $G = \lim_{n \rightarrow \infty} G_n$. Then $G : \mathbb{R}^2 \rightarrow \mathbb{R}^2$ is a homeomorphism and $G \circ \varphi \in \mathcal{E}_C(X)$. \square

Question 5.32 (Question 2 in [4]). *Is there a chainable continuum X and a thick embedding ψ of X such that the set of accessible points of $\psi(X)$ is different from the set of accessible points of $\varphi(X)$ for any thin embedding φ of X ?*

5.7 Uncountably many non-equivalent embeddings

In this section we construct uncountably many non-equivalent embeddings of every chainable continuum which contains an indecomposable subcontinuum. Recall that we use the *strong* definition of equivalent embeddings, *i.e.*, $\varphi, \psi: X \rightarrow \mathbb{R}^2$ are equivalent if $\varphi \circ \psi^{-1}$ can be extended to a homeomorphism of \mathbb{R}^2 .

The idea of the construction is to find uncountably many composants which can be embedded accessible in more than a point. The conclusion then follows easily with the use of the following theorem.

Theorem 5.33 (Mazurkiewicz [68]). *Let $X \subset \mathbb{R}^2$ be an indecomposable planar continuum. There are at most countably many composants of X which are accessible in at least two points.*

Let $X = \varprojlim \{I, f_i\}$, where $f_i: I \rightarrow I$ are continuous piecewise linear surjections.

Definition 5.34. *Let $f: I \rightarrow I$ be a surjection. An interval $I' \subset I$ is called a surjective interval if $f(I') = I$ and $f(J) \neq I$ for every $J \subset I'$. Denote by A_1, \dots, A_n , $n \geq 1$, the surjective intervals of f . For every $i \in \{1, \dots, n\}$, set $R(A_i) = \{x \in A_i : f(y) \neq f(x) \text{ for all } x < y \in A_i\}$, see Figure 5.18.*

We will first assume that the map f_i contains at least three surjective intervals for every $i \in \mathbb{N}$. We will later see that this assumption can be made without loss of generality.

Remark 5.35. *Assume that f has $n \geq 3$ surjective intervals. Then $A_1 \cap A_n = \emptyset$ and $f([l, r]) = I$ for every $l \in A_1$ and $r \in A_n$. Also $f([l, r]) = I$ for every $l \in A_i$ and $r \in A_j$ where $j - i \geq 2$.*

Lemma 5.36. *Let $J \subset I$ be a closed interval and $f: I \rightarrow I$ a map with surjective intervals A_1, \dots, A_n , $n \geq 1$. For every $i \in \{1, \dots, n\}$ there exists an interval $J^i \subset A_i$ such that $f(J^i) = J$, $f(\partial J^i) = \partial J$ and $J^i \cap R(A_i) \neq \emptyset$.*

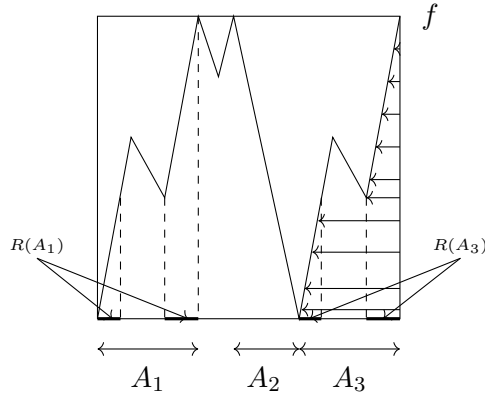

Figure 5.18: Construction of the right accessible sets in the surjective branches. Note that this f has three surjective intervals. For example, note also that $R(A_2) = A_2$.

Proof. Denote the interval $J = [a, b]$ and fix $i \in \{1, \dots, n\}$. Let $a_i, b_i \in R(A_i)$ be such that $f(a_i) = a$ and $f(b_i) = b$. Assume first that $b_i < a_i$, see Figure 5.19. Find the smallest $\tilde{a}_i > b_i$ such that $f(\tilde{a}_i) = a$. Then $J^i := [b_i, \tilde{a}_i]$ has the desired properties. If $a_i < b_i$, then take $J^i = [a_i, \tilde{b}_i]$, where $\tilde{b}_i > a_i$ is the smallest such that $f(\tilde{b}_i) = b$. \square

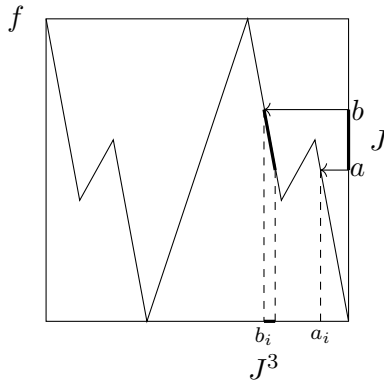

Figure 5.19: Construction of interval J^i from the proof of Lemma 5.36.

The following definition is a slight generalization of the notion of the “top” of a permutation $p(G_f)$ of the graph Γ_f .

Definition 5.37. Let $f : I \rightarrow I$ be a piecewise linear surjection and for a chain C , let p be a C -admissible permutation of G_f . Let $x \in I$ and denote

Chapter 5. Planar embeddings of chainable continua

by $p(f(x))$ the point in $p(G_f)$ which corresponds to the point $f(x)$. We say that x is topmost in $p(G_f)$ if there exists a vertical ray $\{f(x)\} \times [h, \infty)$ which intersects $p(G_f)$ only in $p(f(x))$.

Remark 5.38. If A_1, \dots, A_n are surjective intervals of $f : I \rightarrow I$, then every point in $R(A_n)$ is topmost. Also, for every $i = 1, \dots, n$ there exists a permutation of G_f such that every point in $R(A_i)$ is topmost.

Lemma 5.39. Let $f : I \rightarrow I$ be a map with surjective intervals A_1, \dots, A_n , $n \geq 1$. For $[a, b] = J \subset I$ and $i \in \{1, \dots, n\}$ denote by J^i the interval from Lemma 5.36. There exists an admissible permutation p_i of G_f such that both endpoints of J^i are topmost in $p_i(G_f)$.

Proof. Denote by $A_i = [l_i, r_i]$. Assume first that $f(l_i) = 0$ and $f(r_i) = 1$, thus $a_i < b_i$ (recall the notation a_i, \tilde{a}_i and b_i, \tilde{b}_i from the proof of Lemma 5.36). Find the smallest critical point m of f such that $m \geq \tilde{b}_i$ and note that $f(x) > f(a)$ for all $x \in A_i$, $x > m$. So we can reflect $f|_{[m, r_i]}$ over $f|_{[a_i, m]}$ and $f|_{[r_i, 1]}$ over $f|_{[0, l_i]}$. This makes a_i and \tilde{b}_i topmost, see Figure 5.20. In the case when $f(l_i) = 1, f(r_i) = 0$, thus $a_i > b_i$, we have that $f(x) < f(b)$ for all $x \in A_i$, $x > m$ so we can again reflect $f|_{[m, r_i]}$ over $f|_{[a_i, m]}$ making \tilde{a}_i and b_i topmost. \square

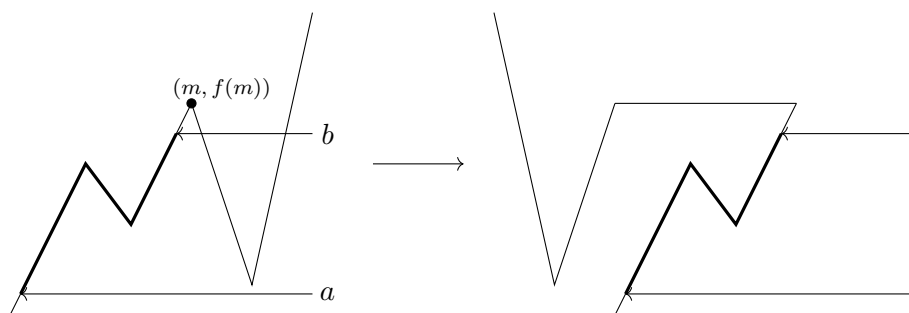

Figure 5.20: Making endpoints of J^i topmost.

Lemma 5.40. Let $X = \varprojlim \{I, f_i\}$, where $f_i : I \rightarrow I$ are continuous piecewise linear surjections and assume that X is indecomposable. If f_i contains at least three surjective intervals for every $i \in \mathbb{N}$, then there exist uncountably many non-equivalent planar embeddings of X .

Chapter 5. Planar embeddings of chainable continua

Proof. For every $i \in \mathbb{N}$ denote by $k_i \geq 3$ the number of surjective branches of f_i and fix $L_i, R_i \in \{1, \dots, k_i\}$ such that $|L_i - R_i| \geq 2$. Let $J \subset I$ and $(n_i)_{i \in \mathbb{N}} \in \prod_{i \in \mathbb{N}} \{L_i, R_i\}$. Then

$$J^{(n_i)} := J \xleftarrow{f_1} J^{n_1} \xleftarrow{f_2} J^{n_1 n_2} \xleftarrow{f_3} J^{n_1 n_2 n_3} \xleftarrow{f_4} \dots$$

is a well defined subcontinuum of X . Here we used the notation $J^{nm} = (J^n)^m$. Moreover, Lemma 5.39 and Corollary 5.21 imply that X can be embedded in the plane such that both points in $\partial J \leftarrow \partial J^{n_1} \leftarrow \partial J^{n_1 n_2} \leftarrow \partial J^{n_1 n_2 n_3} \leftarrow \dots$ are accessible.

Remark 5.35 implies that for every $f : I \rightarrow I$ with surjective intervals A_1, \dots, A_n , every $|i - j| \geq 2$ and every $J \subset I$ it holds that $f([J^i, J^j]) = I$, where $[J^i, J^j]$ denotes the convex hull of J^i and J^j . So if $(n_i), (m_i) \in \prod_{i \in \mathbb{N}} \{L_i, R_i\}$ differ at infinitely many places, then there is no proper subcontinuum of X which contains $J^{(n_i)}$ and $J^{(m_i)}$, *i.e.*, they are contained in different composants of X . Now Theorem 5.33 (see also Brechner [26] and Iliadis [54]) implies that there are uncountably many non-equivalent planar embeddings of X . □

Next we prove that the assumption of at least three surjective intervals can be made without loss of generality for every indecomposable chainable continuum. For $X = \varprojlim \{I, f_i\}$, where $f_i : I \rightarrow I$ are continuous piecewise linear surjections, we show that there is $X' = \varprojlim \{I, g_i\}$ homeomorphic to X such that g_i have at least three surjective intervals for every $i \in \mathbb{N}$.

Remark 5.41. *Assume $f, g : I \rightarrow I$ have two surjective intervals. Note that then $f \circ g$ has at least three surjective intervals. So if f_i has two surjective intervals for every $i \in \mathbb{N}$, then X can be embedded in the plane in uncountably many non-equivalent ways.*

Definition 5.42. *Let $\varepsilon > 0$ and let $f : I \rightarrow I$ be a continuous surjection. We say that f is P_ε if for every two segments $A, B \subset I$ such that $A \cup B = I$ it holds that $d_H(f(A), I) < \varepsilon$ or $d_H(f(B), I) < \varepsilon$, where d_H denotes the Hausdorff distance.*

Chapter 5. Planar embeddings of chainable continua

Remark 5.43. *Let $f : I \rightarrow I$ and $\varepsilon > 0$. Note that f is P_ε if and only if there exist $0 \leq x_1 < x_2 < x_3 \leq 1$ such that one of the following holds*

$$(a) \quad |f(x_1) - 0| < \varepsilon, |f(x_3) - 0| < \varepsilon, |f(x_2) - 1| < \varepsilon, \text{ or}$$

$$(b) \quad |f(x_1) - 1| < \varepsilon, |f(x_3) - 1| < \varepsilon, |f(x_2) - 0| < \varepsilon.$$

Recall that for $n < m$ we denote by $f_n^m := f_n \circ f_{n+1} \circ \dots \circ f_{m-1}$.

Theorem 5.44. *Every indecomposable chainable continuum X can be embedded in the plane in uncountably many non-equivalent ways.*

Proof. Let $X = \varprojlim \{I, f_i\}$, where $f_i : I \rightarrow I$ are continuous piecewise linear surjections. If all but finitely many f_i have at least three surjective intervals, we are done by Lemma 5.40. If for all but finitely many i the map f_i has two surjective intervals, we are done by Remark 5.41.

Now fix a sequence (ε_i) such that $\varepsilon_i > 0$ for every $i \in \mathbb{N}$ and $\varepsilon_i \rightarrow 0$ as $i \rightarrow \infty$. Fix $n_1 = 1$ and find $n_2 > n_1$ such that $f_{n_1}^{n_2}$ is P_{ε_1} . Such n_2 exists by Kuykendall's theorem 2.18. For every $i \in \mathbb{N}$ find $n_{i+1} > n_i$ such that $f_{n_i}^{n_{i+1}}$ is P_{ε_i} . The space X is homeomorphic to $\varprojlim \{I, f_{n_i}^{n_{i+1}}\}$. Every $f_{n_i}^{n_{i+1}}$ is piecewise linear and there exist $x_1^i < x_2^i < x_3^i$ as in Remark 5.43. Take them to be critical points and assume without loss of generality that they satisfy (a) of Remark 5.43. Define a piecewise linear surjection $g_i : I \rightarrow I$ with the same set of critical points as $f_{n_i}^{n_{i+1}}$ such that $g_i(c) = f_{n_i}^{n_{i+1}}(c)$ for all critical points $c \notin \{x_1, x_2, x_3\}$ and $g_i(x_1) = g_i(x_3) = 0$, $g_i(x_2) = 1$. Then g_i is ε_i -close to $f_{n_i}^{n_{i+1}}$. By Mioduszewski [74], $\varprojlim \{I, f_{n_i}^{n_{i+1}}\}$ is homeomorphic to $\varprojlim \{I, g_i\}$. Since every g_i has at least two surjective intervals, this finishes the proof by Remark 5.41. \square

Remark 5.45. *Specifically, Theorem 5.44 proves that the pseudo-arc has uncountably many non-equivalent embeddings in the strong sense. Lewis [62], has already proven this with respect to the weaker version of equivalence, by careful construction of embeddings with different prime end structures.*

In the next theorem we expand the techniques from this section to construct uncountably many non-equivalent embeddings of every continuum that con-

Chapter 5. Planar embeddings of chainable continua

tains an indecomposable subcontinuum. First we give a generalization of Lemma 5.39.

Lemma 5.46. *Let $f : I \rightarrow I$ be a surjective map and let $K \subset I$ be a closed interval. Denote by A_1, \dots, A_n the surjective intervals of $f|_K : K \rightarrow f(K)$, and for $i \in \{1, \dots, n\}$ denote by J^i the intervals from Lemma 5.36 applied to the map $f|_K$.*

Assume $n \geq 4$. Then there exist $\alpha, \beta \in \{1, \dots, n\}$ such that $|\alpha - \beta| \geq 2$ and such that there exist admissible permutations p_α, p_β of G_f such that both endpoints of J^α are topmost in $p_\alpha(G_{f|_K})$, and such that both endpoints of J^β are topmost in $p_\beta(G_{f|_K})$.

Proof. Denote $K = [k_l, k_r]$ and $f(K) = [K_l, K_r]$. Let $x > k_r$ be the smallest local extremum of f such that $f(x) > K_r$ or $f(x) < K_l$. A surjective interval $A_i = [l_i, r_i]$ will be called increasing (decreasing) if $f(l_i) = K_l$ ($f(r_i) = K_l$).

Case 1. Assume $f(x) > K_r$, see Figure 5.21. If $A_i = [l_i, r_i]$ is increasing, since $f(x) > K_r$, there exists an admissible permutation which reflects $f|_{[m,x]}$ over $f|_{[a_i,m]}$ and leaves $f|_{[x,1]}$ fixed. Here m is chosen as in the proof of Lemma 5.39. Since there are at least four surjective intervals, at least two are increasing. This finishes the proof.

Case 2. If $f(x) < K_l$, then we proceed as in the first case but for decreasing A_i . □

Recall another main theorem of this chapter, Theorem 1.9:

Let X be a chainable continuum that contains an indecomposable subcontinuum Y . Then X can be embedded in the plane in uncountably many (strongly) non-equivalent ways.

Proof of Theorem 1.9. Denote by

$$Y := Y_0 \xleftarrow{f_1} Y_1 \xleftarrow{f_2} Y_2 \xleftarrow{f_3} Y_3 \xleftarrow{f_4} \dots$$

If $\varphi, \psi : X \rightarrow \mathbb{R}^2$ are equivalent planar embeddings of X , then $\varphi|_Y, \psi|_Y$ are equivalent planar embeddings of Y . We will construct uncountably many

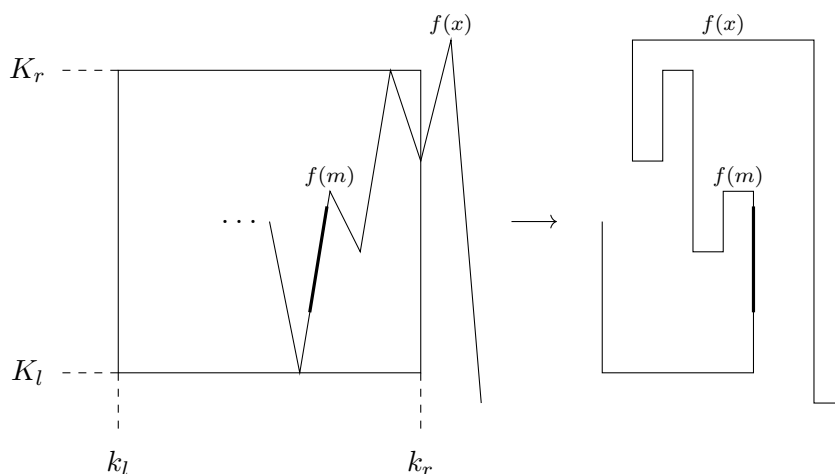

Figure 5.21: Permuting in the proof of Lemma 5.46.

non-equivalent planar embeddings of Y which extend to planar embeddings of X . That completes the proof.

According to Kuykendall's and Mioduszewski's theorem we can assume that $f_i|_{Y_i} : Y_i \rightarrow Y_{i-1}$ has at least four surjective intervals for every $i \in \mathbb{N}$. For a closed interval $J \subset Y_{j-1}$ denote by α_j, β_j the integers from Lemma 5.46 applied to $f_j : Y_j \rightarrow Y_{j-1}$, and denote the appropriate subintervals of Y_j by $J^{\alpha_j}, J^{\beta_j}$. For every sequence $(n_i)_{i \in \mathbb{N}} \in \prod_{i \in \mathbb{N}} \{\alpha_i, \beta_i\}$ we obtain a subcontinuum of Y :

$$J^{(n_i)} := J \xleftarrow{f_1} J^{n_1} \xleftarrow{f_2} J^{n_1 n_2} \xleftarrow{f_3} J^{n_1 n_2 n_3} \xleftarrow{f_4} \dots$$

We used the notation as in the proof of Lemma 5.40. Lemma 5.46 implies that for every (n_i) there exists an embedding of Y such that both points of $\partial J \leftarrow \partial J^{n_1} \leftarrow \partial J^{n_1 n_2} \leftarrow \partial J^{n_1 n_2 n_3} \leftarrow \dots$ are accessible and which can be extended to an embedding of X . This completes the proof. \square

We proved that every chainable continuum which contains indecomposable subcontinuum has uncountably many non-equivalent embeddings. Thus we pose the following question.

Question 5.47. *Which hereditarily decomposable chainable continua have uncountably many non-equivalent planar embeddings?*

Chapter 5. Planar embeddings of chainable continua

Remark 5.48. Mayer has constructed in [67] uncountably many non-equivalent planar embeddings of the $\sin \frac{1}{x}$ continuum by varying the rate of convergence of the ray. This approach readily generalizes to any Elsa continuum (i.e., a continuum consisting of a ray compactifying on an arc). We do not know whether it can be generalized to any chainable continuum which contains a dense ray. Specifically, it would be interesting to see if $\varprojlim \{I, f_{\text{Feig}}\}$ (where f_{Feig} denotes the logistic map at the Feigenbaum parameter) can be embedded in uncountably many non-equivalent ways. However, this approach would not generalize to the remaining hereditarily decomposable continua since there exist hereditarily decomposable continua which do not contain a dense ray, see e.g. [57].

Remark 5.49. Another approach to answering the question above is to use the slightly stronger version of Mazurkiewicz' theorem which states that every indecomposable chainable planar continuum has at most countably many mutually disjoint accessible subcontinua, see Brechner's paper [26]. That theorem partially generalizes from indecomposable continua to chainable continua which contain a dense ray or to arc continua, see [73]. That combined with e.g. the bonding maps having no zigzags produces uncountably many non-equivalent embeddings.

Remark 5.50. It is easy to construct planar continua which have exactly $n \in \mathbb{N}$ or countably many non-equivalent planar embeddings, see Figure 5.22. However, all the examples we know are non-chainable.

Remark 5.51. For inverse limit spaces X with a single unimodal bonding map that are not hereditarily decomposable, Theorems 5.44 and 1.9 hold with weak notion of equivalence too, see [5]. This is because every self-homeomorphism of X is known to be pseudo-isotopic (two self-homeomorphisms f, g of X are pseudo-isotopic if $f(C) = g(C)$ for every composant C of X) to a power of the shift homeomorphism (see [10]), and so any composant can only be mapped to one in a countable collections of composants. Hence, if uncountably many composants can be made accessible (in at least two points), then there are uncountably many non-equivalent embeddings, also w.r.t. weak



Figure 5.22: Left: Planar projection (Schlegel diagram) of the sides of the pyramid with $n \geq 4$ faces (actually any planar representation of a polyhedron with n faces would do) has exactly n non-equivalent embeddings (in the strong sense), determined by the choice of the unbounded face. We are indebted to Tóth Imre Péter for these examples. Continua with exactly $n = 1, 2, 3$ non-equivalent planar embeddings (in the strong sense) are *e.g.* letters T, H, X respectively. In the weak sense, there is only one planar embedding of all this examples. Right: the harmonic comb has countably many non-equivalent embeddings (in both the strong and the weak sense): any finite number of non-limit teeth can be flipped over to the left to produce a non-equivalent embedding.

equivalence. In general there are no such rigidity results on the group of self-homeomorphisms of chainable continua. For example, there are uncountably many self-homeomorphisms on the pseudo-arc up to pseudo-isotopy, since it is homogeneous and indecomposable. Thus we ask the following questions.

Question 5.52. *For which indecomposable chainable continua is the group of self-homeomorphisms at most countable up to pseudo-isotopy?*

For such continua we can conclude that there exist uncountably many non-equivalent planar embeddings in a weak sense. More generally, we ask:

Question 5.53. *Is there a non-arc chainable continuum for which there exist at most countably many non-equivalent (in the weak sense) planar embeddings?*

Bibliography

- [1] L. Alvin, *Hofbauer towers and inverse limit spaces*, Proc. Am. Math. Soc., **141** (2013), 4039–4048.
- [2] L. Alvin, K. Brucks, *Adding machines, endpoints, and inverse limit spaces*, Fund. Math. **209** (2010), 81–93.
- [3] A. Anušić, H. Bruin, J. Činč, *The Core Ingram Conjecture for non-recurrent critical points*, Fund. Math. **241** (2018), 209–235.
- [4] A. Anušić, H. Bruin, J. Činč, *Problems on planar embeddings of chainable continua and accessibility*, In: Problems in Continuum Theory in Memory of Sam B. Nadler, Jr. Ed. Logan Hoehn, Piotr Minc, Murat Tuncali, Topology Proceedings **52** (2018), 283–285.
- [5] A. Anušić, H. Bruin, J. Činč, *Uncountably many planar embeddings of unimodal inverse limit spaces*, DCDS-A **37** (2017), 2285–2300.
- [6] A. Anušić, H. Bruin, J. Činč, *Planar embeddings of chainable continua*, preprint 2018, arXiv:1806.05225 [math.GN]
- [7] A. Anušić, J. Činč, *Accessible points of planar embeddings of tent inverse limit spaces*, preprint 2017, arXiv:1710.11519 [math.DS]
- [8] C. Bandt, *Composants of the horseshoe*, Fund. Math. **144** (1994), 231–241.
- [9] M. Barge, K. Brucks, B. Diamond, *Self-similarity of inverse limits of tent maps*, Proc. Amer. Math. Soc. **124** (1996), 3563–3570.

- [10] M. Barge, H. Bruin, S. Štimac, *The Ingram Conjecture*, *Geom. Topol.* **16** (2012), 2481-2516.
- [11] M. Barge, *Homoclinic intersections and indecomposability*, *Proc. Am. Math. Soc.* **101** (1987), no. 3, 541–544.
- [12] M. Barge, B. Diamond, *Subcontinua of the closure of the unstable manifold at a homoclinic tangency*, *Ergod. Th. and Dynam. Sys.* **19** (1999), 289–307.
- [13] M. Barge, B. Diamond, *Inverse limit spaces of infinitely renormalizable maps*, *Topology Appl.* **83** (1998), 103–108.
- [14] M. Barge, B. Diamond, *Homeomorphisms of inverse limit spaces of one-dimensional maps*, *Fund. Math.* **146** (1995), 171–187.
- [15] M. Barge, S. Holte, *Nearly one-dimensional Hénon attractors and inverse limits*, *Nonlinearity* **8** (1995), no. 1, 29–42.
- [16] M. Barge, W. T. Ingram, *Inverse limits on $[0, 1]$ using logistic bonding maps*, *Topology Appl.* **17** (1996) 173–181.
- [17] M. Barge, J. Martin, *Construction of global attractors*, *Proc. Am. Math. Soc.* **110** (1990), 523–525.
- [18] M. Barge, J. Martin, *Endpoints of inverse limit spaces and dynamics*, *Continua* (Cincinnati, OH, 1994), volume 170 of *Lecture Notes in Pure and Appl. Math.*, 165–182. Dekker, New York, 1995.
- [19] D. P. Bellamy, *A tree-like continuum without the fixed point property*, *Houston J. Math.* **6** (1979), 1–13.
- [20] M. Benedicks, L. Carleson, *The dynamics of the Hénon map*, *Ann. of Math. (2)* **133** (1991), no. 1, 73–169.
- [21] R. Bennett, *On Inverse Limit Sequences*, Master Thesis, University of Tennessee, 1962.
- [22] R. H. Bing, *Snake-like continua*, *Duke Math J.* **18** (1951), 653-663.

- [23] L. Block, J. Keesling, M. Misiurewicz, *Strange adding machines*, Ergod. Th. & Dynam. Sys. **26** (2006), 673–682.
- [24] P. Boyland, A. de Carvalho, T. Hall, *Natural extensions of unimodal maps: prime ends of planar embeddings and semi-conjugacy to sphere homeomorphisms*, arXiv:1704.06624 [math.DS] (2017).
- [25] P. Boyland, A. de Carvalho, T. Hall, *Inverse limits as attractors in parametrized families*, Bull. Lond. Math. Soc. **45**, no. 5 (2013), 1075–1085.
- [26] B. Brechner, *On stable homeomorphisms and imbeddings of the pseudo arc*, Illinois J. Math. **22** Issue 4 (1978), 630–661.
- [27] K. M. Brucks, H. Bruin, Topics from one-dimensional dynamics, London Mathematical Society, Student Texts 62 Cambridge University Press (2004).
- [28] K. M. Brucks, H. Bruin, *Subcontinua of inverse limit spaces of unimodal maps*, Fund. Math. **160** (1999) 219–246.
- [29] K. Brucks, B. Diamond, *A symbolic representation of inverse limit spaces for a class of unimodal maps*, Continuum Theory and Dynamical Systems, Lecture Notes in Pure Appl. Math. **149** (1995), 207–226.
- [30] H. Bruin, *Subcontinua of Fibonacci-like unimodal inverse limit spaces*, Topology Proceedings **31** (2007) no. 1, 37–50.
- [31] H. Bruin, *Inverse limit spaces of post-critically finite tent maps*, Fund. Math. **165** (2000), 125–138.
- [32] H. Bruin, *Planar embeddings of inverse limit spaces of unimodal maps*, Topology Appl. **96** (1999) 191–208.
- [33] H. Bruin, *Topological conditions for the existence of Cantor attractors*, Trans. Am. Math. Soc. **350** (1998) 2229–2263.

-
- [34] H. Bruin, *Combinatorics of the kneading map*, Int. Jour. of Bifur. and Chaos **5** (1995) 1339–1349.
- [35] H. Bruin, S. Štimac, *On isotopy of self-homeomorphisms of quadratic inverse limit spaces*, Top. Proc. **52** (2018), 167–177.
- [36] H. Bruin, S. Štimac, *On isotopy and unimodal inverse limit spaces*, Discrete and Continuous Dynamical Systems **32** (2012), 1245–1253.
- [37] H. Bruin, S. Štimac, *Fibonacci-like unimodal inverse limit spaces and the core Ingram conjecture*, Topological Methods in Nonlinear Analysis (TMNA) **47**, (2016), 147–185.
- [38] A. de Carvalho, *Pruning fronts and the formation of horseshoes*, Ergod. Th. and Dynam. Sys. **19(4)** (1999), 851–894.
- [39] A. de Carvalho, T. Hall, *Pruning theory and Thurston’s classification of surface homeomorphisms*, J. Eur. Math. Soc. **3** (2001), 287–333.
- [40] J. Činč, *Accessible points of some planar continua*, PhD Thesis, University of Vienna, 2017.
- [41] P. Collet, J.-P. Eckmann, *Iterated maps of the interval as dynamical systems*, Birkhäuser, Boston (1980).
- [42] P. Cvitanović, G. Gunaratne, I. Procaccia, *Topological and Metric Properties of Hénon-type Strange Attractors*, Physical Review A **3** Vol. 38, No. 3 (1988), 1503–1520.
- [43] W. Dębski, E. Tymchatyn, *A note on accessible composants in Knaster continua*, Houston J. Math. **19** (1993), no. 3, 435–442.
- [44] H. Freudenthal, *Entwicklungen von Räumen und ihren Gruppen*, Compositio Math., vol. 4 (1937), 145–234.
- [45] C. Good, R. Knight, B. Raines, *Nonhyperbolic one-dimensional invariant sets with a countably infinite collection of inhomogeneities*, Fund. Math. **192** (2006), 267–289.

- [46] C. Good, B. Raines, *Continuum many tent maps inverse limits with homeomorphic postcritical ω -limit sets*, Fund. Math. **191** (2006), 1–21.
- [47] J. Guckenheimer, *Sensitive dependence on initial conditions for unimodal map*, Commun. Math. Phys. **70** (1979) 133–160.
- [48] C. L. Hagopian, L. G. Oversteegen, *Continuum chainability without arcs*, Houston J. of Math. **21** No. 2 (1995), 407–411.
- [49] O. H. Hamilton, *A fixed point theorem for pseudo-arcs and certain other metric continua*, Proc. Amer. Math. Soc. **2** (1951), 173–174.
- [50] G. W. Henderson, *The pseudo-arc as an inverse limit with one binding map*. Duke Math. J. **31** (1964) 421–425.
- [51] M. Hénon, *A two-dimensional mapping with a strange attractor*, Comm. Math. Phys. **50** (1976), no. 1, 69–77.
- [52] J. Hocking, G. Young, *Topology*, Dover (1988).
- [53] F. Hofbauer, *The topological entropy of a transformation $x \rightarrow ax(1-x)$* , Monath. Math. **90** (1980), 117–141.
- [54] S. D. Iliadis, *An investigation of plane continua via Carathéodory prime ends*, Soviet Math. Doklady, vol 13 (1972), 828–832. (Translation from Doklady Akad Nauk SSSR, vol. 204 (1972), 1305–1308 (Russian))
- [55] W. T. Ingram, W. S. Mahavier, *Inverse limits: From Continua to Chaos*, Springer, New York, 2011.
- [56] W. T. Ingram, *Inverse limits on $[0,1]$ using tent maps and certain other piecewise linear bounding maps*, Continua with the Houston problem book (Cincinnati, OH, 1994), in: H. Cook et al. (Eds.), Lecture Notes in Pure and Appl. Math. **170**, Dekker (1995), 253–258.
- [57] J. Januszewski, *International Congress of Math.*, Cambridge, 1912.
- [58] L. Kailhofer, *A classification of inverse limit spaces of tent maps with periodic critical points*, Fund. Math. **177** (2003), 95–120.

- [59] J. Kennedy, J. A. Yorke, *Basins of Wada*, Physica D **51** (1991), 213–225.
- [60] D. P. Kuykendall, *Irreducibility and indecomposability in inverse limits*, Fund. Math. **80** (1973), 265–270.
- [61] W. Lewis, *Continuum theory problems*, Proceedings of the 1983 topology conference (Houston, Tex., 1983). Topology Proc. **8** no. 2 (1983), 361–394.
- [62] W. Lewis, *Embeddings of the pseudo-arc in E^2* , Pacific Journal of Mathematics, vol. **93** no. 1, (1981), 115–120.
- [63] M. Lyubich, *Combinatorics, geometry and attractors of quadratic-like maps*, Ann. of Math. **6** (1993) 425–457.
- [64] W. S. Mahavier, *A chainable continuum not homeomorphic to an inverse limit on $[0, 1]$ with only one bonding map*, Proc. Am. Math. Soc. **18** (1967), 284–286.
- [65] D. S. Marsh, *A chainable continuum not homeomorphic to an inverse limit on $[0, 1]$ with only one bonding map*, Colloq. Math. **43** (1980), 75–80.
- [66] B. Martensen, *The local topological complexity of C^r -diffeomorphisms with homoclinic tangency*, Nonlinearity **16** (2003), 161–186.
- [67] J. C. Mayer, *Inequivalent embeddings and prime ends*, Topology Proc. **8** (1983), 99–159.
- [68] S. Mazurkiewicz, *Un théorème sur l'accessibilité des continus indécomposables*, Fund. Math. **14** (1929), 271–276.
- [69] J. Meddaugh, *Embedding one-dimensional continua into $T \times I$* , Topology and its Applications **153** (2006) 3519–3527.
- [70] W. de Melo, S. van Strien, *One-dimensional dynamics*, Springer Verlag (1993).

- [71] J. Milnor and W. Thurston, *On iterated maps of the interval: I, II*, Preprint 1977., Published in Lect. Notes in Math. 1342, Springer, Berlin New York (1988) 465–563.
- [72] P. Minc, 2^{\aleph_0} ways of approaching a continuum with $[1, \infty)$, *Topology Appl.* **202** (2016), 47–54.
- [73] P. Minc, W. R. R. Transue, *Accessible points of hereditarily decomposable chainable continua*, *Trans. Am. Math. Soc.* **2** (1992), 711–727.
- [74] J. Mioduszewski, *Mappings of inverse limits*, *Colloquium Mathematicum* **10** (1963), 39–44.
- [75] E. Moise, *Geometric Topology in Dimensions 2 and 3*, Springer-Verlag, New York (1977).
- [76] S. B. Nadler, *Continuum Theory: An Introduction*, Marcel Dekker, Inc., New York (1992).
- [77] S. B. Nadler, Jr., *Continua whose cone and hyperspace are homeomorphic*, *Trans. Amer. Math. Soc.* **230** (1977), 321–345.
- [78] S. B. Nadler, *Some results and problems about embedding certain compactifications*, *Proceedings of the University of Oklahoma Topology Conference* (1972) 222–233.
- [79] B. Raines, *Inhomogeneities in non-hyperbolic one-dimensional invariant sets*, *Fund. Math.* **182** (2004), 241–268.
- [80] B. Raines, S. Štimac, *A classification of inverse limit spaces of tent maps with non-recurrent critical point*, *Algebraic and Geometric Topology* **9** (2009), 1049–1088.
- [81] M. Smith, *Plane indecomposable continua no component of which is accessible at more than one point*, *Fund. Math.* **111** (1981), 61–69.
- [82] S. Štimac, *A classification of inverse limit spaces of tent maps with finite critical orbit*, *Topology and its Applications* **154** (2007), 2265–2281.

- [83] S. Štimac, *Structure of inverse limit spaces of tent maps with finite critical orbit*, Fund. Math. **191** (2006), 125–150.
- [84] R. C. Swanson, H. W. Volkmer, *Invariants of weak equivalence in primitive matrices*, Ergodic Theory Dynam. Systems **20** (2000), 611–626.
- [85] R. F. Williams, *One-dimensional non-wandering sets*, Topology **6** (1967), 473–487.
- [86] R. F. Williams, *Classification of one dimensional attractors*, Global Analysis (Proc. Sympos. Pure Math., Vol. XIV, Berkeley, Calif. 1968), Amer. Math. Soc., Providence, R.I (1970), 341–361.
- [87] S. W. Young, *The representation of chainable continua with only two bonding maps*, Proc. Amer. Math. Soc. **23** (1969), 653–654.

Abstract

This thesis studies topological properties of unimodal inverse limit spaces and planar embeddings of chainable continua in general. In the first part we study global and local properties of inverse limit spaces on the unit interval with a single bonding map coming from the tent family. We give symbolic description of arc-components and study the inhomogeneity points of the space. Specifically, we prove that the set of folding points is equal to the set of endpoints if and only if the critical orbit is persistently recurrent, answering the question of Alvin and Brucks from 2010. Also, we make a topological distinction of the arc-component containing the orientation reversing fixed point in the case when the critical orbit is non-recurrent which enables us to prove the Core Ingram conjecture in this case in the positive. To be more precise, we show that the cores of tent inverse limits for which the critical point is non-recurrent are non-homeomorphic for different slopes. The second part of the thesis studies non-equivalent planar embeddings of general chainable continua. We show that every chainable continuum which contains an indecomposable subcontinuum can be embedded in the plane in uncountably many strongly non-equivalent ways, and answer the question of Mayer from 1982 in the unimodal inverse limit case. We also study accessible sets of points of planar embeddings of chainable continua and give a positive answer to the question of Nadler and Quinn from 1972 in case when points are not contained in zigzags of bonding maps.

Keywords: unimodal map, inverse limit space, endpoints, inhomogeneities, Ingram conjecture, chainable continua, planar embeddings, accessible points

Sažetak

Inverzni limesi daju efikasnu metodu za opis prostora dobivenih kao presjek ugnježđenog niza skupova u pripadajućem metričkom prostoru i kao takvi nalaze primjenu u raznim matematičkim područjima. Istaknimo na primjer primjenu inverznih limesa u opisu *hiperboličkih atraktora*. U tezi proučavamo *lančaste kontinuueme*, odnosno inverzne limese u kojima su vezne funkcije preslikavanja na intervalima. U prvom dijelu se restriktiramo na *unimodalne inverzne limese* i proučamo njihova topološka svojstva. Takvi kontinuumi se često pojavljuju kao modeli čudnih atraktora ravninskih homeomorfizama. U drugom dijelu dajemo metodu za konstrukciju različitih planarnih smještenja lančastih kontinuumuuma koristeći metodu *permutacije grafova veznih preslikavanja*.

Preslikavanje na intervalu koje fiksira krajnje točke i ima jedinstveni ekstrem u interioru intervala zovemo *unimodalno*. U tezi se restriktiramo na *šatorske funkcije*, koje, unatoč tome što su vrlo specifične, gotovo u potpunosti opisuju dinamička i topološka svojstva od interesa. Zanimaju nas lokalna i globalna topološka svojstva šatorskih inverznih limesa. Lokalno nas zanimaju točke koje nemaju (otvorene) okoline homeomorfne Kantorovom skupu (otvorenih) lukova. Takve točke zovemo *točke nabiranja*. U tezi dajemo karakterizaciju točaka nabiranja u terminima dinamičkih svojstava veznog preslikavanja i, specijalno, podskupa čije elemente zovemo *krajnje točke*. To su točke x za koje vrijedi da ako su A, B podkontinuumi koji sadrže x , onda $A \subset B$ ili $B \subset A$. Dajemo odgovor na pitanje koje su 2010 postavili Alvin i Brucks, odnosno pokazujemo sljedeći teorem.

Teorem 1.1. Svaka točka nabiranja je krajnja točka ako i samo ako je

kritična točka veznog preslikavanja *uporno rekurentna*.

Naglasimo kako se uporna rekurentnost pojavila kao nužan uvjet za postojanje *divljih atraktora* unimodalnih preslikavanja na intervalu.

Pod globalna topološka svojstva podrazumijevamo strukturu podkontinuumu, kompozanti i lučnih komponenti. U ovom smjeru postoji još mnogo otvorenih pitanja. U tezi dajemo simboličku karakterizaciju lučnih komponenti koristeći svojstva posebnog tipa krajnjih točaka koje zovemo *spiralne točke*. Svojstva specijalne lučne komponente, koja sadrži fiksnu točku jezgre i postoji u svakoj jezgri šatorskih inverznih limesa, nam omogućavaju da damo potpunu karakterizaciju jezgara u slučaju kada je kritična orbita nereakurentna. Dokazujemo sljedeće teoreme.

Teorem 1.3. Ako je $1 < s < \tilde{s} < 2$ i kritične orbite odgovarajućih šatorskih preslikavanja T_s i $T_{\tilde{s}}$ su beskonačne i nereakurentne, onda su jezgre X'_s i $X'_{\tilde{s}}$ nehomeomorfne.

Teorem 1.4. Ako je $1 < s < 2$ takav da T_s ima beskonačnu nereakurentnu kritičnu orbitu i $f: X'_s \rightarrow X'_s$ je homeomorfizam, onda postoji $R \in \mathbb{Z}$ takav da su f i σ^R izotopni.

U drugom dijelu teze proučavamo neekvivalentna planarna smještenja lančastih kontinuumu u punoj općenitosti. Koristimo metodu permutacija grafova veznih preslikavanja i pomoću toga pokazujemo sljedeći teorem.

Teorem 1.7. Svaki lančasti kontinuum koji sadrži indekompozabilni potkontinuum se može smjestiti u ravninu na neprebrojivo mnogo jako neekvivalentnih načina.

Kažemo da su smještenja φ, ψ *jako* neekvivalentna ako se $\varphi \circ \psi^{-1}$ može proširiti do homeomorfizma ravnine. Smještenja su *slabo* neekvivalentna ako postoji homeomorfizam $\varphi(X) \rightarrow \psi(X)$ koji se može proširiti do homeomorfizma ravnine. Mayer je 1982. godine pitao može li se svaki indekompozabilni lančasti kontinuum smjestiti u ravninu na neprebrojivo mnogo (slabo!) neekvivalentnih načina. Dajemo pozitivan odgovor na to pitanje u slučaju unimodalnih

inverznih limesa.

Bavimo se i pitanjem dostupnosti točaka. Točka x planarnog kontinuuma X je *dostupna* ako postoji luk $A \subset \mathbb{R}^2$ takav da je $A \cap X = \{x\}$. Konkretno se bavimo pitanjem Nadlera i Quinna iz 1972. i pokazujemo sljedeći teorem.

Teorem 1.9. Ako je X lančasti kontinuum i $x \in X$ takva da niti jedna projekcija nije u cik-caku veznog preslikavanja, onda postoji smještenje od X u ravninu u kojem je x dostupna.

Na kraju razmatramo otvorena pitanja i dajemo moguće korake prema njihovom rješenju.

Ključne riječi: unimodalno preslikavanje, inverzni limes, krajnje točke, točke nehomogenosti, Ingramova hipoteza, lančasti kontinuumi, planarna smještenja, dostupne točke

Curriculum vitae

Ana Anušić was born on April 7th 1989 in Zagreb, Croatia, where she graduated from 1st Gymnasium in 2007. In 2010 she received a bachelor degree, and in 2012 a masters degree in Theoretical Mathematics from Department of Mathematics, Faculty of Science, University of Zagreb, under the supervision of prof. Sonja Štimac.

In the same year she enrolled in PhD program in Mathematics at the University of Zagreb and became a member of the Zagreb Topology seminar. In the following two years she worked as a part-time teaching assistant at Faculty of Science, Faculty of Naval Engineering and Naval Architecture and Faculty of Electrical Engineering and Computing, University of Zagreb. She was employed as a teaching assistant at Faculty of Electrical Engineering and Computing, University of Zagreb in 2014.

She participated in Austrian–Croatian bilateral grant (ÖAD–MZOŠ) “Strange Attractors and Inverse Limit Spaces”, 2014–2015 (PIs: Henk Bruin, Sonja Štimac) and HRZZ project “Geometric, ergodic, and topological analysis of low-dimensional dynamical systems” (HRZZ-IP-2014-09-2285, PI: Siniša Slijepčević), 2015–2019.

During her PhD studies she made many short-time visits to University of Vienna (total of 5 months) and in December 2017 got awarded a 7-month Ernst Mach research grant (ÖAD, Austria) at the University of Vienna, titled “Inhomogeneities in unimodal inverse limit spaces”, under the supervision of prof. Henk Bruin. She also made two short visits to Indiana University – Purdue University Indianapolis, USA.

She has participated in 14 conferences and workshops all over the world, including Austria, UK, USA, Poland, Slovenia, Czech Republic and Croatia. She has also participated in Budapest-Vienna-Seminar (BudWieSer) and gave multiple talks at Ljubljana–Maribor–Zagreb topology seminar and Ergodic theory and dynamical systems seminar at the University of Vienna. She taught a 6-hour Vienna doctoral school mini-course titled “Dynamics of the unimodal interval family” in 2017.

Publications

- A. Anušić, H. Bruin, J. Činč, *The Core Ingram Conjecture for non-recurrent critical points*, *Fund. Math.* **241** (2018), 209–235.
- A. Anušić, H. Bruin, J. Činč *Problems on planar embeddings of chainable continua and accessibility*, In: *Problems in Continuum Theory in Memory of Sam B. Nadler, Jr.* Ed. Logan Hoehn, Piotr Minc, Murat Tuncali, *Topology Proceedings* **52** (2018), 283–285.
- A. Anušić, H. Bruin, J. Činč, *Uncountably many planar embeddings of unimodal inverse limit spaces*, *Discrete and Continuous Dynamical Systems - Series A* **37** (2017), 2285–2300.

Preprints

- A. Anušić, J. Činč, *Accessible points of planar embeddings of tent inverse limit spaces*, preprint 2017, arXiv:1710.11519 [math.DS]
- A. Anušić, H. Bruin, J. Činč, *Planar embeddings of chainable continua*, preprint 2018, arXiv:1806.05225 [math.GN]

Životopis

Ana Anušić je rođena 7. 4. 1989. u Zagrebu, gdje je 2007. završila Prvu gimnaziju. Godine 2010. završava preddiplomski studij, a 2012. diplomski studij teorijske matematike na Odsjeku za matematiku, PMF, Sveučilište u Zagrebu, pod mentorstvom prof. Sonje Štimac.

Iste godine upisuje doktorski studij matematike Sveučilišta u Zagrebu i postaje članom zagrebačkog topološkog seminara. Sljedeće dvije godine radi kao honorarni asistent na PMF-u, FSB-u i FER-u u Zagrebu. Zaposlena je na radnom mjestu asistenta na FER-u Sveučilišta u Zagrebu od 2014. godine.

Sudjelovala je u austrijsko-hrvatskom bilateralnom projektu (ÖAD–MZOŠ) “Čudni atraktori i inverzni limesi” (voditelji: Henk Bruin i Sonja Štimac) 2014–2015. i HRZZ projektu “Geometrijska, ergodska i topološka analiza nisko-dimenzionalnih dinamičkih sustava” (HRZZ-IP-2014-09-2285, voditelj: Siniša Slijepčević), 2015–2019.

Tijekom doktorskog studija mnogo je puta kratkoročno posjetila Sveučilište u Beču (ukupno 5 mjeseci) i u prosincu 2017. je dobila 7-mjesečnu Ernst Mach stipendiju austrijskog ÖAD-a na Sveučilištu u Beču, pod nazivom “Inhomogeneities in Unimodal inverse limit spaces”, pod vodstvom prof. Henka Bruina. Također je dva puta kratkoročno posjetila Indiana University - Purdue University Indianapolis, SAD.

Sudjelovala je na 14 konferencija i škola po cijelom svijetu, uključujući u Austriji, UK, SAD, Poljskoj, Sloveniji, Češkoj i Hrvatskoj. Također je sudjelovala na Budapest-Vienna-Seminar (BudWieSer) i održala višestruka predavanja

na topološkem seminaru Ljubljana–Maribor–Zagreb i seminaru Ergodic theory and dynamical systems u Beču. Održala je 6-satni mini-kolegij u sklopu Vienna doctoral school pod nazivom “Dynamics of the unimodal interval family” u 2017.

Publikacije

- A. Anušić, H. Bruin, J. Činč, *The Core Ingram Conjecture for non-recurrent critical points*, Fund. Math. **241** (2018), 209–235.
- A. Anušić, H. Bruin, J. Činč *Problems on planar embeddings of chainable continua and accessibility*, In: Problems in Continuum Theory in Memory of Sam B. Nadler, Jr. Ed. Logan Hoehn, Piotr Minc, Murat Tuncali, Topology Proceedings **52** (2018), 283–285.
- A. Anušić, H. Bruin, J. Činč, *Uncountably many planar embeddings of unimodal inverse limit spaces*, Discrete and Continuous Dynamical Systems - Series A **37** (2017), 2285–2300.

Preprinti

- A. Anušić, J. Činč, *Accessible points of planar embeddings of tent inverse limit spaces*, preprint 2017, arXiv:1710.11519 [math.DS]
- A. Anušić, H. Bruin, J. Činč, *Planar embeddings of non-zigzag chainable continua*, preprint 2018, arXiv:1806.05225 [math.GN]

IZJAVA O IZVORNOSTI RADA

Ja, _____, student/ica Prirodoslovno-matematičkog
fakulteta Sveučilišta u Zagrebu, s prebivalištem na adresi
_____, OIB _____,

JMBAG _____, ovim putem izjavljujem pod materijalnom i kaznenom
odgovornošću da je moj završni/diplomski/doktorski rad pod naslovom:

_____, isključivo moje autorsko djelo, koje je u
potpunosti samostalno napisano uz naznaku izvora drugih autora i dokumenata korištenih u radu.

U Zagrebu, _____

Potpis