

Observational detection of meteor-produced VLF electromagnetic radiation

Garaj, S.; Vinković, D.; Kovačić, D.; Gradečak, S.; Biliškov, N.; Grbac, N.; Andreić, Željko

Source / Izvornik: **Fizika A, 1999, 8, 91 - 98**

Journal article, Published version

Rad u časopisu, Objavljena verzija rada (izdavačev PDF)

Permanent link / Trajna poveznica: <https://um.nsk.hr/um:nbn:hr:217:524298>

Rights / Prava: [In copyright](#)/[Zaštićeno autorskim pravom.](#)

Download date / Datum preuzimanja: **2024-08-05**



Repository / Repozitorij:

[Repository of the Faculty of Science - University of Zagreb](#)



OBSERVATIONAL DETECTION OF METEOR-PRODUCED VLF
ELECTROMAGNETIC RADIATIONS. GARAJ^{a,b}, D. VINKOVIĆ^c, G. ZGRABLIĆ^a, D. KOVAČIĆ^a, S. GRADEČAK^a,
N. BILIŠKOV^a, N. GRBAC^a and Ž. ANDREIĆ^d^a*Department of Physics, Faculty of Science, University of Zagreb, Bijenička 32,
10000 Zagreb, Croatia*^b*I. G. A. – Département de Physique, École Polytechnique Fédérale de Lausanne,
CH-1015 Lausanne - EPFL, Switzerland (E-mail: Slaven.Garaj@epfl.ch)*^c*Department of Physics and Astronomy, University of Kentucky, Lexington, KY 40506,
USA*^d*Thin Films Laboratory, Department of Materials Science, “R. Bošković” Institute,
Bijenička 54, 10000 Zagreb, Croatia***Dedicated to Professor Boran Leontić on the occasion of his 70th birthday**

Received 24 November 1999; revised manuscript received 15 February 2000

Accepted 21 February 2000

In November 1998, Croatian Physical Society's expedition to Mongolia was undertaken. The goal was to make measurements of the puzzling electrophonic sounds and very low frequency (VLF) radio emission from meteors during the anticipated Leonid meteor storm. During the night of 16/17 November 1998, an extremely high fireball activity of the Leonid meteors occurred. During this period, we performed measurements of the VLF radiation from meteors. Here we present a positive signal which consists of a sequence of sharp, short VLF bursts, coincident with the appearance of meteor that was recorded by the video camera. This is the first completely controlled instrumental recording of such an event.

PACS numbers: 96.50.Kr, 94.20.-y, 94.20.Bb

UDC 523.682, 52.583

Keywords: VLF radio emission from meteors, fireball activity, Leonid meteors, Mongolia, Croat. Phys. Soc. expedition November 1998

1. Introduction

The meteor-related electrophonic sounds are defined as sounds heard simultaneously with the appearance of a bright meteor. Although their existence and possible relation to “electric matter” [1] was recognized already in the 18th cen-

tury, they are still a puzzling natural phenomenon. To date, thousands of witness reports have been cataloged and published in scientific journals (see Ref. [2] and references therein). The fact that puzzled so many scientists is that any normal sound produced by the meteors would travel at least a few minutes to the observer on the ground, as the meteors usually burn-out at heights of 50 – 100 km. So, the electrophonic sounds must have a different origin. A distinction between the normal sound (sonic boom) and electrophonic (anomalous) sound is very important. The sonic boom can be generated only by a large meteoroid which penetrates deep enough in the atmosphere (below 50 km), while the electrophonic sound can also be associated with smaller meteors which disintegrate at much higher altitudes (up to 80 km).

The first generally accepted mechanism of the origin of electrophonic sounds was suggested by Keay in 1980 [3] and theoretically modeled by Bronshten [4] (KB-theory hereafter). According to their theory, a bright fireball can under special conditions produce ELF/VLF radio waves [the low frequency end of electromagnetic spectrum is divided into ULF (frequencies below 300 Hz), ELF (300 Hz – 3 kHz) and VLF (3 kHz – 30 kHz) bands] by trapping and tangling Earth's magnetic field in the turbulent plasma tail of an ablating meteoroid. This electromagnetic radiation can be converted into sound by an ordinary object in the observer's vicinity. The main conclusions of this theory are that very bright fireballs are needed to generate VLF, and they set the lower limit to -12^m (about equal to the brightness of a full Moon). Keay also tried to relate electrophonic sounds with aurora sounds [5] and pointed to VLF as the source of these sounds. The support for his assumptions he found in old records of auroral sounds [3,5,6] but no clear conclusions were drawn. Much more important are the results of his laboratory experiments on generation of sound by different objects in large VLF fields that clearly demonstrate the ability of VLF radiation to produce audible sound [3,7].

Keay [8] refined the KB theory in 1992 and predicted that VLF can be generated at the moment of the explosive desintegration of a bolide, which lowered the limiting brightness of a meteor capable of producing electrophonic sounds. More recently, Beech and Foschini proposed "Electrophonic bursters" theory [9]. This theory is based on the separation of charges in the plasma shock wave during the airburst. This separation creates a strong electric field within the shock front, which acts to restore the plasma neutrality.

Keay and Ceplecha tried to predict the average number of electrophonic sounds that should be heard by a single person [10], based on data presented by Ceplecha [11,12]. The prediction says that a person who would spend every night all night outside has a once in a lifetime chance of hearing an electrophonic sound, with a comment that this is a very optimistic prediction as today many such events would be masked by man-made sounds and would pass unnoticed.

In 1991, Keay considered the detection of a meteor VLF emission by Japanese observers [13,14]. They managed to obtain simultaneous photographic and ELF/VLF records of a -7^m Perseid meteor. One member of their photographic team heard an electrophonic sound, but it was not recorded. The ELF/VLF signal lasted less than 0.2 s and they offered no detail about the synchronization of

photographic light curve with the ELF/VLF detection.

In 1995, another VLF detection was reported by Beech, Brown and Jones [15]. From the intensity of the VLF signal produced by a -10^m bolide, the authors derived a quite strong electric field of a few kilovolts per meter. From the description of the experimental procedure, although incomplete, one can infer that the authors had overlooked the fact that the variable-gain amplifier in their video-recorder (a plain video recorder was used for recording the audio signals) is active all the time, so the actual electric field could be several orders of magnitude weaker than the reported value. Again, no reliable time synchronization was established.

The third ELF/VLF detection was obtained by our group during the activity of the Leonid meteor shower in 1995 [16] and our conclusions were similar to those of previous authors.

It must be pointed out that the above described measurements were not done in fully controlled experimental condition and were subjected to serious objections. The natural ELF/VLF spectrum is a continuous source of interference and only precise time correlation with the meteor's light curve can provide convincing evidence. Therefore, we decided to use the synchronized video and ELF/VLF observations.

2. Observational set-up

Having in mind that the meteor ELF/VLF radiation and related electrophonic sound are extremely rare phenomena, a large sample of bright meteors must be observed. This can be achieved either by a long observational campaign or by an exceptionally high rate of bright meteors. The predicted Leonid meteor storm over East Asia on the night of 17/18 November 1998 [17] was expected to be such an occasion. Historical records from the great Leonid meteor storm in 1833 suggest that large Leonids are capable of producing electrophonic sounds [18]. Considering these facts, Croatian Physical Society's scientific expedition to Mongolia was organized from 10 until 24 November 1998. Although the Leonids did not show storm activity, they showed an exceptionally large number of very bright fireballs during the night of November 16/17th [19]. This was actually more favourable for our measurements. We succeeded to detect ELF/VLF emission from meteors and, for the first time, recorded the electrophonic sounds [20].

To be sure that real signals are detected, a number of conservative constraints were implemented in the design of the recording set-up. The correlation of the VLF signal with the appearance of the meteor is of crucial importance. Thus, for the visual recording of meteors, we decided to use a high-sensitivity CCD camera with a professional VHS video recorder. With this set-up, we were able to record four audio channels¹ simultaneously with the video channel, which allowed a perfect time synchronization.

Two spatially separated sets of VLF receivers are highly desirable to exclude local interference. Local natural and artificial sources cause this interference. Ad-

¹VLF signals are of so low frequencies that they are usually best recorded on audio equipment

ditional (global) natural noise is mainly related to radio waves generated in the Earth's atmosphere and transmitted by the ionosphere (static, tweaks, whistlers, etc.) and it cannot be avoided by a separate set of antennas. Although most of it can be distinguished by spectral analysis, static noise can accidentally happen at the time of a meteor appearance and be confused with the VLF signal from the meteor. Hence, the perfect time synchronization is very important. Artificial noise is produced by electrical networks and AC-current appliances, usually with many higher harmonics. They can be significantly minimized by appropriate choice of the observational location. Additional artificial noises can be due to the marine navigational systems or military communications but they are easily recognized in spectrograms as they are almost monochromatic.

Environmental sound should be monitored for possible electrophonic sounds. To exclude the local noise, several spatially and acoustically separated sets of microphones are desirable. Last, but not least, accurate time calibration should also be provided, and all recordings should be synchronized as well as possible.

The observations were conducted from a uninhabited region about 20 km

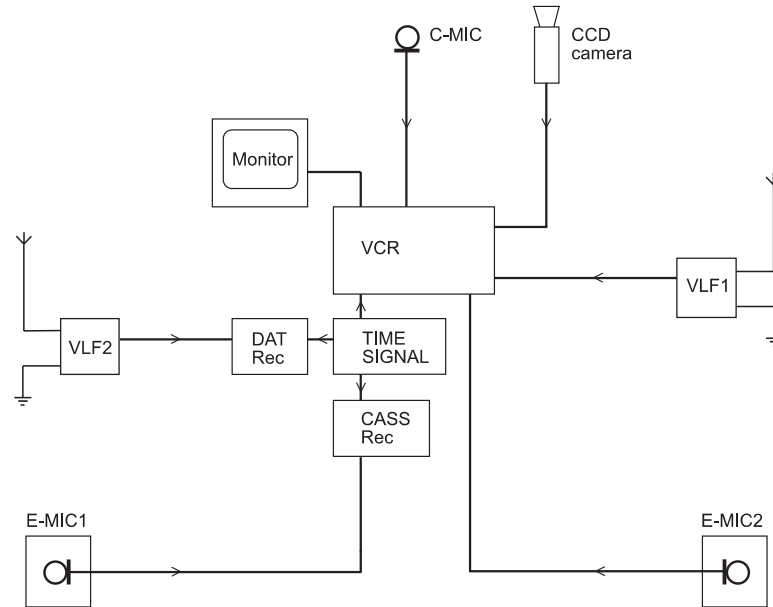

Fig. 1. The schematics of recording set-up used for the described VLF detection. Video signal from a CCD camera was recorded by a professional VHS video-recorder with 4 sound channels. An accurate time signal is recorded in one of these channels to provide absolute time reference for other channels. The other channels were used for a VLF detector (VLF1), observers comments (C-MIC) and a separate environmental sound microphone (E-MIC2). A digital sound recorder (DAT) supported another VLF detector and a cassette recorder supported a spare environmental sound microphone (E-MIC1).

southeast of Ulan Bator, Mongolia. There was almost no vegetation, and the relatively flat ground was covered with snow. The humidity was extremely low, and the temperature during the observations was between -20° C and -30° C. The scheme of experimental set-up is shown in Fig. 1. We used two separated and locally grounded VLF receivers with whip antennas. To avoid local interference, the antennas were well separated from each other and from visual observers. The frequency sensitivity of the receiver (with threshold $< 10^{-3}$ V/m), is shown in Fig. 2. Notice that the sensitivity has its maximum at 1 kHz and that it is very low below 500 Hz. Another part of the experimental set-up was used to monitor environmental sound.

A CCD video camera with a sky coverage of 55% and a limiting magnitude of 0^m was placed near the visual observation site. Absolute time signal from the Taškent radio station at 5.000 MHz was recorded simultaneously with other signals on each recorder used. Simple photometry was performed on the video frames, each one with the 0.04 s exposition (25 frames/s frame rate). A dark frame was created by averaging six frames 0.5 s before the frames with visible meteors. After the dark frame had been subtracted from the frames with meteors, a simple integration of the remaining pixel values was performed. Sirius was used for the calibration of the magnitude scale. The two main sources of error associated with this procedure are the outermost contour used in the integration and the comparison of the resulting intensity with Sirius. Due to the low signal/noise level of the Sirius image, this was the principal source of error which was estimated at about $\pm 0.5^m$. The overall accuracy of the synchronization between the different recording channels was better than ± 0.02 s.

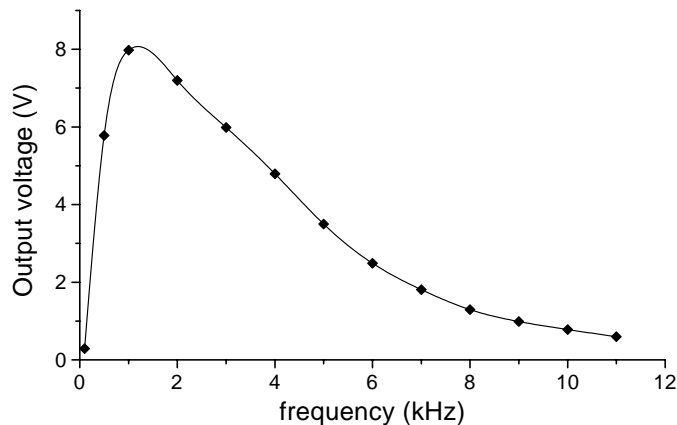

Fig. 2. The relative frequency response of the VLF receiver.

3. Discussion

In total, 5.5 hours of observations of an extremely high fireball rate were recorded during the night of 16/17 November 1998. In addition to the ELF/VLF

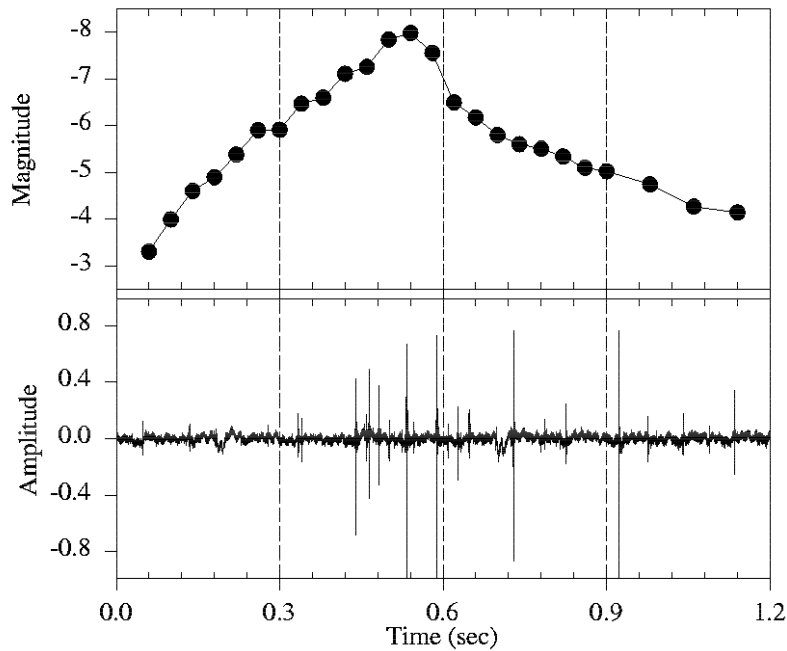

Fig. 3. Recorded ELF/VLF emission from a $-8^m \pm 0.5^m$ meteor. Upper panel shows the meteor brightness recorded by video, and the lower panel is the signal in the ELF/VLF channel during that event (amplitude is given in arbitrary units). Time $0.0 \text{ s} = 21^{\text{h}} 44^{\text{m}} 35.1^{\text{s}}$ UT (16 Nov. 1998). The accuracy of synchronization between the video and ELF/VLF channels is $\pm 0.02 \text{ s}$.

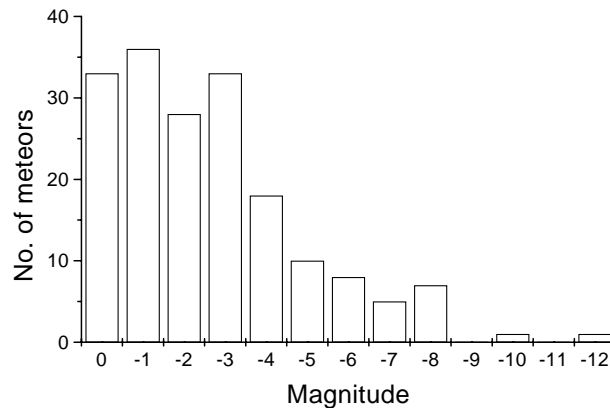

Fig. 4. The brightness distribution of meteors recorded by video camera in the four-hours time interval around the time of the appearance of the VLF producing meteor. This was used for the calculation of probability for VLF signal – meteor appearance correlation.

signals from meteors known before, we obtained several new recordings, for the first time with undisputed time correlation between the video and ELF/VLF signals. No electrophonic sound was detected for these events. The most interesting VLF signal is shown in Fig. 3. A meteor with a visual magnitude of -8 ± 0.5^m was observed at $21^{\text{h}} 44^{\text{m}} 35.1^{\text{s}}$ UT. It appeared very close to the horizon and the final part of the trajectory was partially obscured by a hill, but the light maximum is clearly visible in the video record.

A sequence of short VLF pulses appeared simultaneously with the meteor's light maximum. We calculated the chance that an uncorelated static appeared in this time window. From a sample of natural VLF signals recorded during the period of this expedition, and from the frequency of bright meteors observed, we found the probability for the appearance of an uncorrelated VLF outburst in an arbitrary 0.1 s time interval. The probability is of the order of 1% or smaller, giving us a strong confidence that this VLF event is related to the meteor. The distribution of magnitudes of meteors observed in the four-hour time interval around the time of appearance of the VLF producing meteor is given in Fig. 4.

4. Conclusions

We are presenting the first detection of the VLF emission from meteors done in fully controlled experimental conditions. The Leonids in 1998 showed an unusually large number of very bright fireballs during the night of 16/17th November. Several VLF signals from the meteors were recorded simultaneously with the visual appearance of meteors. They are indeed caused by meteors, since other sources of the signals are excluded on the basis of a very low statistical probability of unusual static coincident with the meteor's light maximum.

These positive recordings suggest that the brightness limit for VLF emission is much lower than previously thought. It is probably around -5^m , but one can not exclude that this limit depends on weather conditions, as already suggested by Keay [5]. This is in general agreement with the theory of Keay and Bronshten of rapid expulsion and relaxation of the Earth's magnetic field by the fireball during the light maximum, when the fireball is not bright enough to reach the phase of a turbulent wake.

The electrophonic sounds were not recorded during any of the VLF events. This can be explained by the insufficient intensity of the signal or the absence of proper objects for electrophonic conversion. If they would have the needed values of electric field, the signals may be related to the "crackling" electrophonic sounds.

Nevertheless, a much larger sample of detected events is needed for a more definite conclusion. It is obvious that the theoretical models have to take into account non-static and non-isotropic properties of the ionosphere and the meteor trail.

Acknowledgements

We wish to express our gratitude for the financial and organizational help to the Croatian Physical Society, University of Kentucky, NASA Inspire project (for

supplying us with the VLF receiver), Faculty of Science, University of Zagreb, Institute of Physics, Zagreb, "R. Bošković" Institute, Zagreb, Institute Open Society – Croatia and to the foundation "Zaklada Hrvatskog Državnog Zavjeta".

References

- 1) C. Blagden, Phil. Trans. Roy. Soc. London **74** (1784) 201;
- 2) V. Yu. Kaznev, Solar System Res. **28** (1994) 49;
- 3) C. S. L. Keay, Science **210** (1980) 11;
- 4) V. A. Bronshten, Solar System Res. **17** (1983) 70;
- 5) C. S. L. Keay, J. Roy. Astron. Soc. Can. **74** (1980) 253;
- 6) C. S. L. Keay, J. Roy. Astron. Soc. Can. **84** (1990) 373;
- 7) C. S. L. Keay and P. M. Ostwald, J. Acous. Soc. Am. **89** (1991) 1823;
- 8) C. S. L. Keay, Meteoritics **27** (1992) 144;
- 9) M. Beech and L. Foschini, Astron. Astrophys. **345** (1999) L27;
- 10) C. S. L. Keay and Z. Ceplecha, J. Geophys. Res. E **99** (1994) 13163;
- 11) Z. Ceplecha, Astron. Astrophys. **263** (1992) 361;
- 12) Z. Ceplecha, Astron. Astrophys. **286** (1994) 967;
- 13) C. S. L. Keay, *Asteroids, Comets, Meteors 1991*, Lunar and Planetary Institute, Houston (1992) pp. 297-300;
- 14) T. Watanabe, T. Okada and K. Suzuki, HAM Journal (Japan) **54** (1988) 109 (in Japanese);
- 15) M. Beech, P. Brown and J. Jones, Earth, Moon, and Planets **68** (1995) 181;
- 16) N. Biliškov, S. Garaj, S. Gradečak, N. Grbac and G. Zgrablić, *Report on the Student Project Presented to the University of Zagreb, Zagreb* (1995) (in Croatian);
- 17) P. Jenniskens, Meteoritics and Planetary Science **31** (1996) 177;
- 18) D. Olmsted, Am. J. Sci. Arts **25** (1834) 363;
- 19) R. Arlt, WGN **26** (1998) 239;
- 20) G. Zgrablić, D. Vinković, S. Gradečak, D. Kovačić, N. Biliškov, N. Grbac, Ž. Andreić and S. Garaj, submitted for publication.

OPAŽANJE NISKOFREKVENTNOG ELEKTROMAGNETSKOG ZRAČENJA PROIZVEDENOG METEOROM

Ekspedicija Hrvatskog fizikalnog društvo uputila se u Mongoliju u studenom 1998 radi promatranja očekivane kiše meteora i mjerenja neobičnih elektrofonskih šumova i niskofrekventnog elektromagnetskog zračenja proizvedenog meteorima. U noći 16/17 studenog 1998. došlo je do izrazito pojačane aktivnosti sjajnih meteora Leonida. U tom smo periodu mjerili elektromagnetske valove VLF i istovremeno snimali meteore. Ovdje izvješćujemo o zabilježenom signalu elektromagnetskih valova koji se sastojao od niza kratkotrajnih niskofrekventnih impulsa, koji se pojavio istovremeno s meteorom. Ovo je prvo instrumentalno bilježenje te pojave načinjeno u potpuno kontroliranim uvjetima.